

Read me first

1. The "**LOAD SETUP DEFAULTS**" function loads the system default data directly from ROM and initializes the associated hardware properly. This function is necessary when you accept this mainboard, or the system CMOS data will corrupt.

ROM PCI/ISA BIOS CMOS SETUP UTILITY AWARD SOFTWARE, INC.	
STANDARD CMOS SETUP	SUPERVISOR PASSWORD
BIOS FEATURES SETUP	USER PASSWORD
CHIPSET FEATURES SETUP	IDE HDD AUTO DETECTION
POWER MANAGEMENT SETUP	HDD LOW LEVEL FORMAT
PNP/PCI CONFIGURATION SETUP	LOAD SETUP Default (Y/N)? Y
INTEGRATED PERIPHERALS SETUP	SAVING
LOAD SETUP DEFAULTS	
ESC: QUIT	↑↓→← :SELECT ITEM
F10: Save & Exit Setup	(Shift)F2 :Change Color
Load Setup Defaults Except Standard COMS SETUP	

LOADSETUPDEFAULT

2. **KBPO (KeyBoard Power On)** Function : There is a basic requirement that the "+5V SB" power of the ATX power supply must be $\geq 0.1A$ (100mA). Please refer to chapter 2-5 for detail.

Apollo MVP3 AGPset

EP-58 MVP3C-M

ISA/PCI/AGP MainBoard

with Onboard PCI IDE and Super Multi-I/O.

TRADEMARK

All products and company names are trademarks or registered trademarks of their respective holders.

The specification is subject to change without notice.

V121

Package Checklist

Please check your package which should include all items listed below.
If you find any item damaged or missed, please contact your supplier.

- One mainboard
- One manual
- One IDE ribbon cable
- One floppy ribbon cable
- One Parallel port ribbon cable
- One Serial port ribbon cable(COM1,COM2)
- One PS/2 mouse cable(Optional)
- One AGP driver diskette
- One Ultra_DMA IDE driver diskette

Contents

	page
Chapter 1 - Introduction.....	1-1
Chapter 2 - Hardware Design	2-1
2-1 Mainboard Layout.....	2-1
2-2 Connectors and Jumpers.....	2-3
2-3 System Memory Configuration.....	2-5
2-4 ATX Power ON/OFF Control.....	2-6
2-5 External Modem Ring-in Power ON and Keyboard Power ON Functions.....	2-7
2-6 Integrated PCI Bridge.....	2-8
Chapter 3 - Award BIOS Setup	3-1
3-1 Standard CMOS Setup.....	3-2
3-3 BIOS Features Setup.....	3-2
3-3 Chipset Features Setup.....	3-6
3-4 Power Management Setup.....	3-8
3-5 PNP/PCI Configuration.....	3-10
3-6 Integrated Peripherals.....	3-12
3-7 Load Setup Defaults.....	3-14
3-8 Change Supervisor or User Password	3-15
3-9 IDE HDD Auto Detection.....	3-16
3-10 HDD Low Level Format.....	3-18
3-11 Save & Exit Setup.....	3-18
3-11 Exit Without Saving.....	3-18
Chapter 4 - Onboard Technical Information	4-1
4-1 I/O & Memory Map.....	4-1
4-2 Time & DMA Channels Map.....	4-2
4-3 Interrupt Map.....	4-2
4-4 RTC & CMOS RAM Map.....	4-3
Appendix A: Post Codes.....	4-4
Appendix B: I/O Connector.....	4-8
Appendix C: AGP Driver for Win95 Installation Guide.....	4-9

Chapter 1

Introduction

This mainboard is a high performance system hardware based on Intel Pentium processor and is equipped with an AGP slot, four PCI slots, three standard ISA slots, Super Multi-I/O controller and dual port PCI-IDE connectors for the future expansion. The hardware dimension is 220mm x 260mm with a four-layer-design technology.

Specification

- VIA Apollo MVP3 AGP/PCiset chipset.
- Intel **Pentium**[®] Processor, Pentium Processor with MMX technology, AMD K5/K6, Cyrix 6x86L/6x86MX & *idt* C6 operating at **120 ~ 500 MHz** with **321 ZIF socket 7** provides scalability to accept faster Processors in the future.(only version 1.0 or above does support processor of 400/450MHz AMD K6-2/3).
- Supports up to 384 MegaBytes of memory (168-Pin DIMM SOCKET x 3).
- Supports 512KB (Pipelined Burst SRAM) L2 **Cache**.
- Supports three 16 bit ISA slots ,four 32 bit PCI slots and an AGP slot and provides two independent high performance PCI IDE interfaces capable of supporting **PIO Mode 3/4** and **Ultra-DMA33** devices.
- Supports **ATAPI** (e.g. **CD-ROM**) devices on both IDE interfaces.
- Supports a floppy port, a parallel port (EPP,ECP port), two serial ports (16550 Fast UART compatible), 1 USB Connector, a PS/2 style mouse connector and an AT style keyboard connector.
- Supports Award Plug & Play BIOS.
- Supports CPU Hardware sleep, APM (Advanced Power Management) and *ACPI (Advanced Configuration Power Interface)*.
- Supports an *ATX power supply connector* for a *Remote On/Off*, a *Phone-Ring Power On* and a *Keyboard Power On* Function.
- Supports *Switching Regulator* for CPU power supply. and *single jumper for CPU working voltage selection*.
- *Supports ESDJ (Easy Setting Dual Jumper) function for CPU selection.*
- *Support hardware monitor function.*

Chapter 2

Hardware design

2-1 Mainboard Layout

This mainboard is designed with VIA Apollo MVP3 AGP/PCiset chipset which is developed by VIA Corporation to fully support Pentium Processor PCI/ISA system. By providing a massive increase in the bandwidth available between the video card and the processor (66MHz), the unique feature of AGP supported by VIA Apollo MVP3 chipset improves the speed of rendering and texturing for 3D graphics. The chipset also provides an integrated IDE controller with two high performance IDE interfaces for up to four IDE devices (hard devices, CD-ROM device, etc). The Winbond W83877TF Super I/O controller provides the standard PC I/O function: one floppy interface, two 16 Byte FIFO serial ports and one EPP/ECP capable parallel port. This mainboard layout is shown in the next page for user's reference. **Care must be taken** when inserting memory modules, CPUs or even plugging PCI card into associated slots to avoid damaging any circuits or sockets on board. A cooling fan is strongly recommended when installing Pentium/Pentium MMX/K5/K6/6x86/6x86L/6x86MX/C6 processor due to possible overheat.

This mainboard supports a minimum of 8MB and a maximum of 384MB of System Memory while Onboard 512KB cache to increase system performance.

This mainboard supports standard Fast Page, EDO (Extended Data Out or Hyper Page Mode) or synchronous DRAM. **This mainboard** provides three 168-pin DIMM sites for memory expansion. The sockets support 1M x 64(8MB), 2M x 64 (16MB), 4M x 64(32MB), and 8M x 64(64MB) single-sided or double-sided memory modules. The memory timing requires 70 ns Fast page devices or 60 ns EDO DRAM. (DRAM Modules may be parity [x 36] or non-parity [x 32].

This mainboard supports **two Onboard PCI IDE** connectors, and automatically detects IDE harddisk type by BIOS utility automatic.

This mainboard supports Award Plug & Play BIOS for the ISA and PCI cards. The BIOS can be located in Flash EPROM which can replace BIOS code easily if necessary.

EP-58MVP3C-M Layout

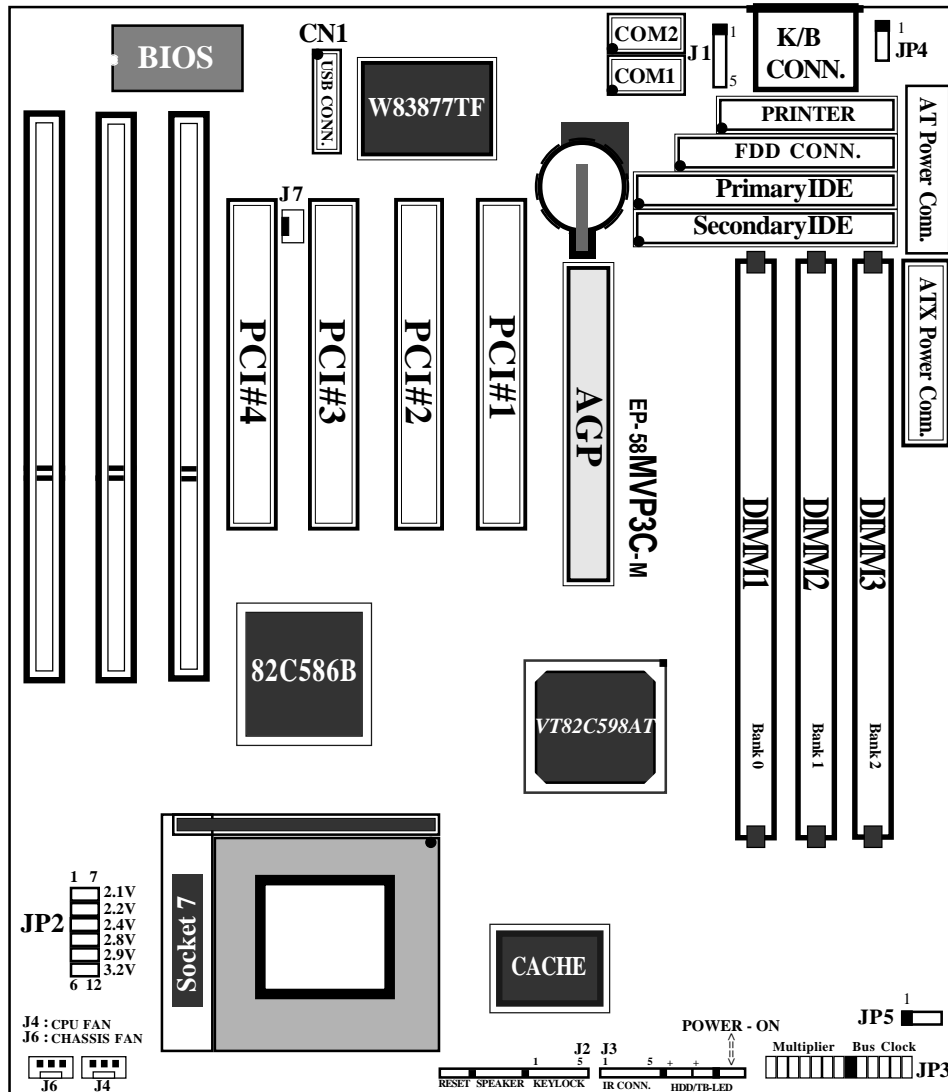
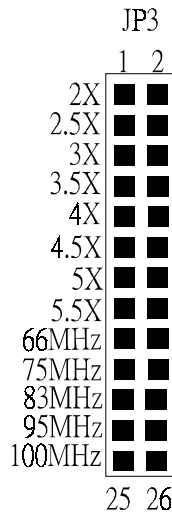

Figure 2-1

2-2 Connectors and Jumpers

This section describes the connectors and jumpers equipped in the mainboard. Please refer to **Figure 2-1** for the location of each connector and jumper.

Pentium/MMX AMD K5/K6 IDT-C6	JP3		Cyrix/IBM 6x86MX/MII
	Multiplier	Bus Clock	
166MHz	2.5X	66MHz	PR200
		75MHz	PR233
		83MHz	PR266
		95MHz	PR300
250MHz	3X	100MHz	PR366
200MHz		66MHz	PR266
		75MHz	PR300
250MHz		83MHz	PR333
		95MHz	*PR400
300MHz		100MHz	*PR433
233MHz	3.5X	66MHz	PR300
		75MHz	PR333
		83MHz	*PR400
333MHz		95MHz	*PR466
350MHz	4X	100MHz	*PR500
266MHz		66MHz	PR333
		75MHz	PR400
333MHz		83MHz	*PR466
380MHz		95MHz	*PR533
400MHz		100MHz	*PR550
300MHz	4.5X	66MHz	
450MHz		100MHz	
333MHz	5X	66MHz	
475MHz		95MHz	
500MHz		100MHz	
366MHz	5.5X	66MHz	







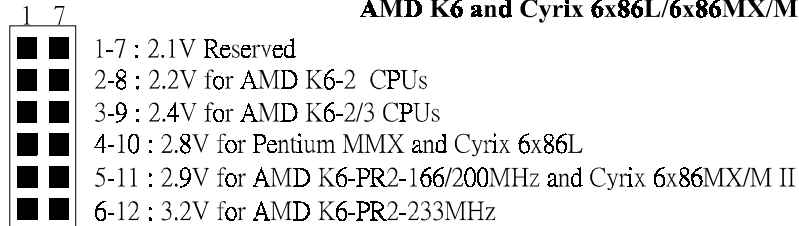

* These CPUs are not available in the marketing for testing yet, when this manual is written.

JP2:

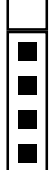
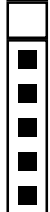
CPU Vcore voltage selection : For Pentium Processor with MMX technology, AMD K6 and Cyrix 6x86L/6x86MX/M II

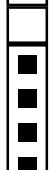

6 12

- J2**
- | | |
|---|---|
|  | <p>Reset Switch - Closed to restart system.</p> |
|  | <p>Speaker - connect to the system's speaker for beeping.</p> <p>1. Speaker
2. N/C
3. GND
4. VCC</p> |
|  | <p>KeyLock - Keyboard lock switch & Power LED connector.</p> <p>1. Power LED(+)
2. N/C
3. GND
4. Key-Lock
5. GND</p> |
- J3**
- | | |
|---|---|
|  | <p>IrDA/ASK IR CONNECTOR</p> <p>1. VCC
2. NC
3. IRRX
4. GND
5. IRTX</p> |
|  | <p>IDE LED indicator - LED ON when harddisks activate.</p> <p>Turbo LED indicator - LED ON when higher speed is selected.
There is no deturbo function so that the turbo LED is always ON.</p> |
|  | <p>Power-ON - Push the button to turn on the system.</p> <ul style="list-style-type: none"> - Pressing less than 4 seconds to enter the suspend mode - Pressing more than 4 seconds to turn off the system |
- J4**
- | | |
|---|---------------------------------|
|  | <p>CPU FAN Connector</p> |
|---|---------------------------------|
- J6**
- | | |
|---|-------------------------------------|
|  | <p>CHASSIS FAN Connector</p> |
|---|-------------------------------------|
- J7**
- | | |
|---|---|
|  | <p>WOL(Wake-up On Lan) Connector</p> |
|---|---|

2-3 System Memory Configuration

This mainboard supports different type of settings for the system memory. The following figures and table provides all possible memory combinations.

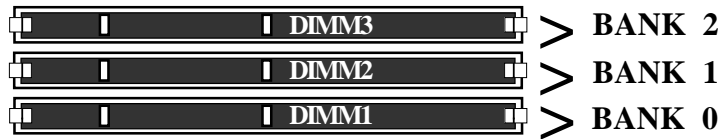

DIMM 1 BANK 0	DIMM 2 BANK 1	DIMM 3 BANK 2	TOTAL MEMORY
<div style="display: flex; align-items: center;"> <div style="border: 1px solid black; padding: 2px; margin-right: 5px;"> 8MB 16MB 32MB 64MB 128MB </div> <div style="margin-left: 5px;">x 1</div> </div>	<div style="display: flex; align-items: center;"> <div style="border: 1px solid black; padding: 2px; margin-right: 5px;"> 8MB 16MB 32MB 64MB 128MB </div> <div style="margin-left: 5px;">x 1</div> </div>	<div style="display: flex; align-items: center;"> <div style="border: 1px solid black; padding: 2px; margin-right: 5px;"> 8MB 16MB 32MB 64MB 128MB </div> <div style="margin-left: 5px;">x 1</div> </div>	MAX.= 384MB

This mainboard supports 2 kinds of powerful and flexible SDRAM frequency selections. These can be synchronous with CPU bus clock or fixed as 66MHz. By implementing the VCS (Virtual Clock Synchronization) technology, this mainboard refers to the use of delay-lock-loop (DLL) to enable synchronous and pseudo-synchronous operation of the processor and DRAM, AGP and PCI buses. The JP5 allows user to set the SDRAM Frequency between 66/100MHz.

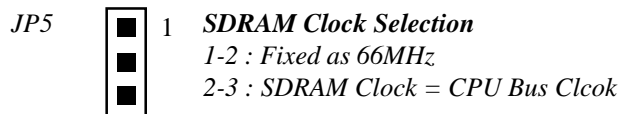

Jumper's position:

1-2 : Pseudo-synchronous Status(Fixed as 66MHz)

A more stable and compatible operation condition for non-100MHz based SDRAM when you are using 100MHz based CPU. This setting is suitable for those users who are like to remain the usage of current SDRAM module.

2-3 : Synchronous Status(SDRAM Clock= CPU Bus Clock)

Increasing the bus speeds from the traditional 66MHz to 100MHz greatly improves system performance because the speed at which data traveling between the CPU and memory is increased by 50%. However, there is one thing you should bear in mind. Please make sure you are using 125MHz(-8) based or above SDRAM module.

2-4 ATX Power ON/OFF Control

This mainboard equips an ATX power connector which is a single 20-PIN input device for an ATX power supply (see Figure 2-2). An ATX power supply provides a built-in Remote Power ON/OFF function. To implement the function, a momentary switch which is normally open should be connected to the position J3(PIN 12, 13) as the system's power ON/OFF button. Note that an AT power supply does not offer this function.

Based on the ATX power connector, this mainboard has been designed to support both *ACPI* and *Soft-OFF* functions. According to the definition of *ACPI*, a *Suspend mode* will be enabled while you push the J3(system power ON/OFF) button less than 4 seconds. Nevertheless, the system will be turned off by pressing for more than 4 seconds. Regarding the *Soft-OFF*(coming from this mainboard onboard circuit controller), it is another way to turn off your system. Your system can be shut down automatically by an operation system such as Windows 95.

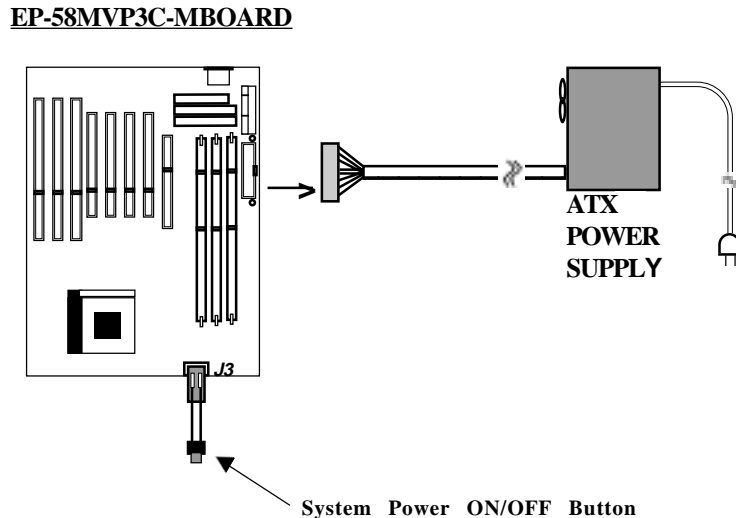

Figure 2-2: Simple ATX Power ON/OFF Controller

2-5 External Modem Ring-in Power ON and Keyboard Power ON Functions

On the basis of bounded functions in I/O chipset, the two serial ports are able to support the External Modem Ring-in Power ON function. Once users connect the external modem to COM1 or COM2, this mainboard mainboard allows users to turn on their system through the remote and host's dial-up control.

Exclusive Keyboard Power ON Function

To innovate a unique feature to benefit users, we devoted ourselves to create the easiest and most convenient way to turn on your system based on the the ATX power supply. This function is available only under system being connected to ATX power supply.

How to work with it

Step 1: Please place JP4 at the position 2-3 after you finished the system installation.

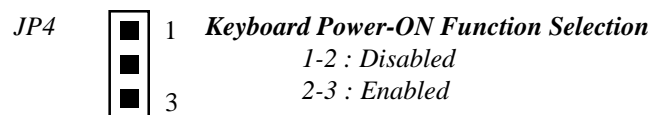

Step 2 : Push the momentary switch to turn on your system and then push again to hold for more than 4 seconds to turn it off as soon as you turn it on.

Step 3: You can enjoy the Keyboard Power ON function by *pressing any 1 or 2 keys on you keyboard at the same time* for 1-2 seconds. Your system will be turned on automatically, after releasing the keys. To power off you system, you can use the Soft-OFF function under Windows 95.

Notes:

1. The number of keys needed to turn on a system depends on the model of keyboard you are applying due to different loadings on different keyboards. Here, we would like to suggest you push 2 keys at the same time..
2. Intel ATX version 2.0 specification has recommended you use the power supply with 0.72A(720mA). With our EP-58MVP3C-M mainboard, *the 5.0VSB standby power only has to be $\geq 0.1A$ (100mA)* then you can enjoy this unique benefit. However, the ATX power supply which is < 0.1 (100mA) is still applicable to your system by placed JP4 at the position 1-2 to disable this feature.

2-6 Integrated PCI Bridge

This **mainboard** utilizes **VIA Apollo MVP3 AGP/PCIs**et chipset to support Intel Pentium Processor PCI/ISA system. The VIA Apollo MVP3 PCIs et chipset consists of the 82C598AT system controller (TSC), and one 82C586B PCI ISA/IDE Accelerator bridge chip. It provides an interface which translates CPU cycle into PCI bus cycle, and PCI burst read/write capability. In addition, it provides high performance PCI arbitor to support four PCI Masters, Rotating Priority Mechanism, and Hidden Arbitration Scheme Minimizes Arbitration Overhead.

There are four interrupts in each PCI slot : INTA#, INTB#, INTC#, and INTD#. Since this mainboard adapts the PCI auto-configuration with the system BIOS Setup utility. When the system is turned on after adding a PCI add-in card, the BIOS automatically configure interrupts, DMA channels, I/O space, and other paramaters. You do not have to configure jumpers or worry about potential resource conflicts. Because PCI cards use the same interrupt resource as ISA cards, you must specify the interrupt used by ISA add-in cards in the BIOS Setup utility.

However, if a "Legacy card" (such as plugging a paddle card and cable into an ISA slot) is plugged in the system, modification in the **ROM SETUP UTILITY** becomes necessary. First of all, you must enter **PCI CONFIGURATION SETUP** utility from the **ROM SETUP UTILITY** main menu to set "ISA" for the "**PCI IDE IRQ MAP TO**

Secondly, you must enter the **CHIPSET FEATURES SETUP UTILITY** from the **ROM SETUP UTILITY** main menu and set "Disabled" for the "**Onboard Primary PCI IDE**" and the **Onboard Secondary PCI IDE**. When you plug PCI/ISA IDE cards into the system, You should select "Disabled" for the **Onboard Primary and Secondary PCI IDE** from the **CHIPSET FEATURES SETUP UTILITY** too.

You can set the system interrupt request (IRQ) on some "Legacy cards" which have on paddle card and cable. (refer to user's manual of the card) to a proper system IRQ level (In general, card's Primary is assigned to INTA and Secondary is assigned to INTB). If the card is plugged into slot 1 (marked PCI#1), you cannot use second slot (marked PCI#2) because the Secondary INT signal takes INTB from the slot (refer to Page 3-12 for circuit diagram). The user then enters the **PCI CONFIGURATION SETUP** utility from the **ROM SETUP UTILITY** main menu and set "PCI-Slot 1" for the "**PCI IDE IRQ MAP TO**" (This depends on the slot # where the Legacy card is plugged).

CHAPTER 3

AWARD BIOS SETUP

Award's ROM BIOS provides a built-in setup program which allows user to modify the basic system configurations and hardware parameters. The modified data will be stored in a battery-backed CMOS RAM so that data will be retained even when the power is turned off. In general, the information saved in the CMOS RAM stays unchanged unless there is a configuration change in the system, such as a hard drive replacement or a new device installation.

If this does happen, you will need to reconfigure your configuration parameter.

To Enter Setup Program

Power on the computer and press key immediately. This will bring you into BIOS CMOSSETUPUTILITY.

ROMPCI/ISA BIOS(2A5LEPA9) CMOSSETUPUTILITY AWARDSOFTWARE,INC.	
STANDARD CMOS SETUP	SUPERVISOR PASSWORD
BIOS FEATURES SETUP	USER PASSWORD
CHIPSET FEATURES SETUP	IDE HDD AUTO DETECTION
POWER MANAGEMENT SETUP	HDD LOW LEVEL FORMAT
PNP/PCI CONFIGURATION	SAVE & EXIT SETUP
INTEGRATED PERIPHERALS	EXIT WITHOUT SAVING
LOAD SETUP DEFAULTS	
ESC : QUIT	↑ ↓ → ← : SELECT ITEM
F10 : Save & Exit Setup	(Shift)F2 : Change Color
Time, Date, Hard Disk Type...	

Figure 3-1 CMOSSETUPUTILITY

The menu displays all major selection items. Select the item you need to reconfigure. The selection is made by moving cursor (press any direction key) to the item and press the 'Enter' key. An on-line help message is displayed at the bottom of the screen as the cursor is moving to various items which provides a better understanding of each function. When a selection is made, the menu of selected item will appear so the user can modify the associated configuration parameters.

3-1 STANDARD CMOS SETUP

Choose "STANDARD CMOS SETUP" in the CMOS SETUP UTILITY Menu (Fig.3-1). The STANDARD CMOS SETUP allows user to configure system setting such as the current date and time, type of hard disk installed, floppy type, and display type. Memory size is auto-detected by the BIOS and displayed for your reference. When a field is highlighted (use direction keys to move cursor and <Enter> key to select), the entries in the field will be changed by pressing <PgDn> or <PgUp> keys or user can enter new data directly from the keyboard.

ROM PCI/ISA BIOS(2A5LEPA9)																	
STANDARD CMOS SETUP																	
AWARD SOFTWARE, INC.																	
Date (mm:dd:yy) : Wed, Jan 15 1998																	
Time (hh:mm:ss) : 14 : 30 : 50																	
HARD DISKS	TYPE	SIZE	CYLS	HEAD	PRECOMP	LANDZONE	SECTORS	MODE									
Primary Master	: Auto	0	0	0	0	0	0	Auto									
Primary Slave	: Auto	0	0	0	0	0	0	Auto									
Secondary Master	: Auto	0	0	0	0	0	0	Auto									
Secondary Slave	: Auto	0	0	0	0	0	0	Auto									
Drive A : 1.44M,3.5 in.				<table border="1"> <tr> <td>Base Memory</td> <td>: 640K</td> </tr> <tr> <td>Extended Memory</td> <td>: 15360K</td> </tr> <tr> <td>Other Memory</td> <td>: 384K</td> </tr> <tr> <td colspan="2">Total Memory : 16384K</td> </tr> </table>						Base Memory	: 640K	Extended Memory	: 15360K	Other Memory	: 384K	Total Memory : 16384K	
Base Memory	: 640K																
Extended Memory	: 15360K																
Other Memory	: 384K																
Total Memory : 16384K																	
Drive B : None																	
Floppy 3 mode Support : Disable																	
Video : EGA/VGA																	
Halt On : All Errors																	
ESC : Quit		↑ ↓ → ← : Select Item			PU/PD/+/- : Modify												
F1 : Help		(Shift) F2 : Change Color															

Figure 3-2 STANDARD CMOS SETUP

NOTE: If the Primary Master/Slave and the Secondary Master/Slave are set as "Auto", the hard disk size and model will be auto-detected.

NOTE: The "Halt On :" field is to determine when to halt the system by the BIOS if an error occurs.

3-2 BIOS FEATURES SETUP

By selecting the "BIOS FEATURES SETUP" option in the CMOS SETUP UTILITY menu, user can change system related parameters in the displayed menu. This menu shows all of the manufacturer's default values of this mainboard. Again, user can move the cursor by pressing direction keys and <PgDn> or <PgUp> keys to modify the parameters. Pressing [F1] key to display help message of the selected item.

ROM PCI/ISA BIOS(2A5LEPA9) BIOS FEATURES SETUP AWARD SOFTWARE, INC.			
Virus Warning	: Disabled	Video BIOS	Shadow : Enabled
CPU Internal Cache	: Enabled	C8000-CBFFF	Shadow : Disabled
External Cache	: Enabled	CC000-CFFFF	Shadow : Disabled
Quick Power On Self Test	: Enabled	D0000-D3FFF	Shadow : Disabled
Boot Sequence	: A, C, SCSI	D4000-D7FFF	Shadow : Disabled
Swap Floppy Drive	: Disabled	D8000-DBFFF	Shadow : Disabled
Boot Up Floppy Seek	: Enabled	DC000-DFFFF	Shadow : Disabled
Boot Up NumLock Status	: On	Diskette Access For	: All
Boot Up System Speed	: High		
Gate A20 Option	: Fast		
Memory Parity/ECC Check	: Disabled		
Typematic Rate Setting	: Disabled		
Typematic Rate (Chars/Sec)	: 6		
Type matic Delay (Msec)	: 250		
Security Option	: Setup	Esc : Quit	↑ ↓ → ← : Select Item
PCI/VGA Palette Snoop	: Disabled	F1 : Help	PU/PD/+/- : Modify
OS Select For DRAM > 64MB	: Non-OS2	F5 : Old Values	(Shift)F2 : Color
		F7 : Load Setup Defaults	

Figure 3-3 BIOS FEATURES SETUP

Note: The **Security Option** contains "setup" and "system". The "setup" indicates that the password setting is for CMOS only while the "system" indicates the password setting is for both CMOS and system boot up.

- **Virus Warning:** This category flashes on the screen. During and after the system boots up, any attempt to write to the boot sector or partition table of the hard disk drive will halt the system and an error message will appear. You should then run an anti-virus program to locate the virus. Keep in mind that this feature protects only the boot sector, not the entire hard drive. Default value is Disabled.

Enabled : Activates automatically when the system boots up causing a warning message to appear when any attempt to access the boot sector or hard disk partition table.

Disabled : No warning message to appear when any attempt to access the boot sector or hard disk partition table.
- **CPU Internal Cache / External Cache:** These two categories speed up memory access. However, it depends on CPU/chipset design. The default value is Enabled. If your CPU is without Internal Cache then this item "CPU Internal Cache" will not be shown.

Enabled : Enable cache.

Disabled : Disable cache.

- **Quick Power On Self Test:** This category speeds up Power On Self Test (POST) after you power on the computer. If it is set to Enable, BIOS will shorten or skip some checking items during POST.
Enabled : Enable quick POST.
Disabled: Normal POST.
- **Boot Sequence:** This category determines which drive is searched first for the O/S(Operating System).The default value is A,C.
*A,C :*The system will search for floppy disk drive first then hard disk drive.
*C,A :*The system will search for hard disk drive first then floppy disk drive.
- **Swap Floppy Drive:** This will swap your physical drive letters A&B if you are using two floppy disks. The default value is Disabled.
Enabled : Floppy A & B will be swapped under the O/S.
Disabled : Floppy A & B will be not swapped.
- **Boot Up Floppy Seek:** During Power-On-Self-Test (POST), BIOS will determine if the installed floppy drive is 40 or 80 tracks. Only 360K type is 40 tracks while 760K, 1.2M and 1.44M are all 80 tracks. The default value is Enabled.
Enabled : BIOS searches for floppy disk drive to determine if it is 40 or 80 tracks.
Note that BIOS cannot tell from 720K, 1.2M or 1.44M drive type as they are all 80 tracks.
Disabled: BIOS will not search for the type of floppy disk drive by track number.
Note that there will not be any warning message if the drive installed is 360K.
- **Boot Up NumLock Status:** The default value is On.
On : Keypad is number keys.
Off : Keypad is arrow keys.
- **Boot UP System Speed:** Select default system speed. The system will run at the selected speed after the system boots.
High: Set the speed to high.
Low : Set the speed to low.
- **Gate A20 Option:** This refers to the way the system addresses memory above 1MB (extended memory). The default value is Fast.
Normal: The A20 signal is controlled by keyboard controller or chipset hardware.
Fast : The A20 signal is controlled by Port 92 or chipset specific method.

- **Typematic Rate Setting:** This determines the typematic rate.
Enabled : Enable typematic rate and typematic delay programming.
Disabled: Disable typematic rate and typematic delay programming. The system BIOS will use default value of 2 items and the default is controlled by the keyboard.

- **Typematic Rate(Chars/Sec):**

6 : 6 characters per second.	8 : 8 characters per second.
10 : 10 characters per second.	12 : 12 characters per second.
15 : 15 characters per second.	20 : 20 characters per second.
24 : 24 characters per second.	30 : 30 characters per second.

- **Typematic Delay(Msec):** This determines the time between the first and second character displayed, when holding a key.
250 : 250msec.
500 : 500 msec.
750 : 750 msec.
1000: 1000msec.

- **Security Option:** This category allows you to limit access to the system and Setup, or just to Setup. The default value is Setup.
System: The system will not boot and the access to Setup will be denied if the correct password is not entered at the prompt.
Setup : The system will boot, but the access to Setup will be denied if the correct password is not entered at the prompt.

- **PCI/VGA Palette Snoop:** This filed controls the ability of a primary PCI VGA controller to share a common palette (when a snoop write cycles) with an ISA video card. The default value is Disabled.
Enabled:If an ISA card connects to a PCI VGA card via the VESA connector and the ISA card connects to VGA monitor and uses the RAMDAC of PCI card, the PCI/VGA Palette Snoop is enabled.
Disabled:Disable the VGA card Palette snoop function.

- **Video BIOS Shadow:** It determines whether video BIOS will be copied to RAM. However, it is optional from chipset design. Video Shadow will increase the video speed.
Enabled : Video shadow is enabled.
Disabled: Video shadow is disabled.

- **C8000 - CBFFF Shadow :**
- CC000 - CFFFF Shadow:**
- D0000 - D3FFF Shadow:**
- D4000 - D7FFF Shadow:**
- D8000 - DBFFF Shadow:**
- DC000 - DFFFF Shadow:**

These categories determine whether optional ROM will be copied to RAM by 16K byte or 32K byte per unit and the size depends on the chipset.

Enabled : Optional shadow is enabled.

Disabled: Optional shadow is disabled.

3-3 CHIPSET FEATURES SETUP

Choose the "CHIPSET FEATURES SETUP" in the CMOS SETUP UTILITY menu to display the following menu.

ROM PCI/ISA BIOS(2A5LEPA9) CHIPSET FEATURES SETUP AWARD SOFTWARE, INC.			
Bank 0/1 DRAM Timing	: 60 ns	System/CPU Warning Temp.	: 66C/151C
Bank 2/3 DRAM Timing	: 60 ns	Current System Temp.	: 28C/82C
Bank 4/5 DRAM Timing	: 60 ns	Current CPU Temp.	: 30C/86C
SDRAM Cycle Length	: 2	Current CPU Fan Speed	: 0 RPM
SDRAM Bank Interleave	: 2 Bank	Current Chassis Fan Speed	: 0 RPM
DRAM Read Pipeline	: Enabled	CPU Vcore(V)	: 3.16V
Sustained 3T Write	: Enabled	CPU Vio(V)	: 3.53V
Cache Rd+CPU Wt Pipeline	: Enabled	+5V	: 4.89V
Read Around write	: Enabled	+12V	: 11.73V
Cache Timing	: Fastest	-12V	: -12.26V
Linear Burst	: Enabled	-5V	: -5.07V
Video BIOS Cacheable	: Enabled		
System BIOS Cacheable	: Disabled		
Memory Hole At 15Mb Addr.	: Disabled		
AGP Aperture Size	: 64M		
AGP Transfer Mode	: 1x		
Cyrix M2 ADS# delay	: Enabled		
		Esc : Quit	↑ ↓ → ← : Select Item
		F1 : Help	PU/PD/+/- : Modify
		F5 : Old Values	(Shift)F2 : Color
		F7 : Load Setup Defaults	

Figure3-4 CHIPSET FEATURES SETUP

Note: When you insert slower memory modules in the system and set a faster timing, maybe the system will hang up.

- **DRAM Timing:** The default value is 60ns.
60ns : 2 (faster) Burst Wait State, for 60~70ns Fast Page Mode/EDO DRAM.
70ns : 3 (slower) Burst Wait State, for 70ns Fast Page Mode/EDO DRAM.
- **SDRAM Cycle length:** The default value is 2.
2 : 2 HCLKS.
3 : 3 HCLKS.
- **SDRAM Bank Interleave:** The default value is 2 Bank.
Disabled : Normal Setting.
2 Bank/4 Bank : SDRAM 2 or 4 Bank Interleave.
- **DRAM Read Pipeline:** The default value is Enabled.
Disabled : Normal Setting.
Enabled : This field enables the pipelining of DRAM read cycle.
- **Sustained 3T Write:** The default value is Enabled.
Disabled : Write Back mode L2 Cache.
Enabled : Write Through mode L2 Cache.
- **Cache RD+CPU Wt Pipeline:** The default value is Enabled.
Disabled : Normal Setting.
Enabled : This field enables the pipelining of Cache reads and CPU writes cycle.
- **Read Around Write:** The default value is Enabled.
Disabled : Normal Setting.
Enabled : This field enables the memory read around write cycle.
- **Cache Timing:** The default value is Fastest.
Fast : Cache burst mode timing = 3 1 1 1 2 1 1 1.
Fastest : Cache burst mode timing = 3 1 1 1 1 1 1 1.
- **Video BIOS Cacheable:** The default value is Enabled.
Enabled : Enabled the Video BIOS Cacheable to speed up the VGA Performance.
Disabled : Disabled the Video BIOS Cacheable function.
- **System BIOS Cacheable:** The default value is Disabled.
Enabled : Allow caching of the system BIOS ROM at F0000h-FFFFFh.
Disabled : Normal Setting.
- **Memory Hole at 15M-16M:** The default value is Disabled.
Disabled : Normal Setting.
Enabled : This field enables the main memory (15~16MB) remap to ISA BUS.

- **AGP Aperture Size:** The amount of the system memory that the AGP card is allowed to share. The options available are 4M, 8M, 16M, 32M, 64M, 128M, 256M. The default value is 64M.
- **AGP Transfer Mode:** The default value is 1X.
1X : 66MHz AGP transfer mode.
2X: 133MHz AGP transfer mode.
- **Cyrix M2 ADS# Delay:** The default value is Enabled.
Disabled : Normal Setting.
Enabled: Delay 1 HCLK for Cyrix 6x86MX when the ADS# assert.
- **System/CPU Warning Temp:** The default value is 66C/151F.
Disabled : Normal Setting.
Enabled: The options available is 50C/122F~70C/158F.
- **Current System Temp:** This is the current temperature of the system.
- **Current CPU Temp:** This is the current temperature of the CPU.
- **Current CPU Fan Speed:** The current CPU fan speed in RPMs.
- **Current ChassisFan Speed:** The current chassis fan speed in RPMs .
- **CPU(V)** : The voltage level of the CPU(Vio/Vcore).
- **+5V / +12V / -12V / -5V** : The voltage level of the power supply.

3-4 POWER MANAGEMENT SETUP

Choose the "POWERMANAGEMENTSETUP" in the CMOSSETUPUTILITY to display the following screen. This menu allows the user to modify the power management parameters and IRQ signals. In general, these parameters should not be changed unless it is absolutely necessary.

ROM PCI/ISA BIOS(2A5LEPA9) POWER MANAGEMENT SETUP AWARD SOFTWARE, INC.			
Power Management	: User Define	Primary INTR	: ON
PM Control by APM	: Yes	IRQ3 (COM 2)	: Primary
Video off Option	: Suspend -> Off	IRQ4 (COM 1)	: Primary
Video off Method	: V/H SYNC+Blank	IRQ5 (LPT 2)	: Primary
Soft-off by PWRBTN	: Delay 4 Sec	IRQ6 (Floppy Disk)	: Disabled
** RM Timers **		IRQ7 (LPT 1)	: Primary
HDD Power Down	: Disable	IRQ8 (RTC Alarm)	: Disabled
Doze Mode	: Disable	IRQ9 (IRQ2 Redir)	: Primary
Suspend Mode	: Disable	IRQ10(Reserved)	: Primary
** RM Events **	IRQ11	(Reserved)	: Primary
VGA	: OFF	IRQ12(PS/2 Mouse)	: Primary
LPT & COM	: LPT /COM	IRQ13(Coprocessor)	: Primary
HDD & FDD	: OFF	IRQ14(Hard Disk)	: Primary
DMA /master	: OFF	IRQ15(Reserved)	: Disabled
Modem Ring Resume	: Disabled		
MODEM Use IRQ	: Enabled		
RTC Alarm Resume	: Disabled		
		Esc : Quit	↑ ↓ ← → : Select Item
		F1 : Help	PU/PD/+/- : Modify
		F5 : Old Values	(Shift)F2 : Color
		F7 : Load Setup Defaults	

Figure 3-5 POWERMANAGEMENTSETUP

Again, users can move the cursor by pressing direction keys to the field needed to be modified and press <PgDn> or <PgUp> to alter item selection. You can only change the content of **Doze Mode**, **Standby Mode**, and **Suspend Mode** when the **Power Management** is set to 'User Define'.

3-3-1 The Description of the Power Management

A. Power Management mode selection :

Disabled : The system operates in NORMAL conditions (Non-GREEN) and the Power Management function is disabled.

Max. saving: This mode will maximize the power saving capability.

Min. saving: This mode will minimize the power saving capability.

User define: Allow user to define time-out parameters to control power saving mode. Refer to item B shown below.

B. Time-out parameters :

HDD Standby

HDD Standby timer can be set from 1 to 15 minute(s).

System Doze

The "System Doze" mode timer starts to count when there is no "PM events" occurred. The valid time-out setting is from 1 minute up to 1 hour.

System Suspend

This function works only when the Pentium Procissor is installed. The timer starts to count when "System Standby" mode timer is timed out and no "PM Events" occurred. Valid range is from 1 minute up to 1 hour.

3-3-2 Description of the Green Functions

This mainboard supports HDD Power Down, Doze and Suspend power saving functions. In addition, the hardware suspend function is supported when the J3(12,13) (Refer to Figure2-1) is closed to enter the Suspend function.

The detailed description of these functions is provided in the next page.

- **PM Control by APM**

If Advanced Power Management(APM) is installed on your system, selecting *Yes* gives better power savings.

- **Video Off Method**

Determines the manner in which the monitor is blanked.

V/HSYNC+Blank: System turns off vertical and horizontal synchronization ports and writes blanks to the video buffer.

DPMS Support: Select this option if your monitor supports the Display Power Management Signaling (DPMS) standard of the Video Electronics Standards Association (VESA). USE the software supplied for your video subsystem to select video power management values.

Blank Screen: System only writes blanks to the video buffer.

- **Video off Option**

Determines when to activate the video off feature for monitor power management. The settings are Video off after Suspend/standby/Doze/(N/A).

- **Soft-off by PWRBTN**

This field is for the soft-off function setting. When the board utilizes an ATX power supply, two types of settings are offered: *Delay 4 Sec.* and *instant-off*. When the setting is *Delay 4 Sec.*, users can power off the system by pressing POWER-ON button(J3) for 4 seconds. However, if users press POWER-ON button for less than 4 seconds, the system will enter the Suspend Mode. When the setting is *instant-off*, users' first press on POWER-ON button will power off the system, but the second press will power on the system.

- **RTC Alarm Resume**

This option allows you to have the system turn on at a preset time each day or on a certain day. This option is only available when used an ATX power supply.

Enabled : The system will turn on at the preset time.

Disabled : Normal Setting

- **Date(ofmonth)**

This field is to set the date that the system will turn on. The default value is 0.

0 : Turn on the system on everyday at the preset time.

1-31 : Represets the date of the month that you need the system to turn on.

- **Time(hh:mm:ss)**

This field is to set the time that you need the system to turn on. The default value is 08:00:00.

HDDStandbyMode

When system stops reading or writing HDD, the timer starts to count. The system will cut off the HDD power when timer runs out of time. The system will not resume operation until either a read from or a write to HDD command is executed again.

DozeMode

The system hardware will drop down CPU clock from normal working speed when Doze mode time-out occurs.

SuspendMode

When the system suspend timer times out, the system will enter the suspend mode and the chipset will stop CPU clock immediately. The power consumption in Suspend Mode is lower than in standby mode. The screen is also blanked out.

PMEvents:

AWARD BIOS defines 7 PM Events in the power management mode (Doze & suspend). The user can initialize any PM Events to be "Enable" or "Disable". When the system detects all of the enabled events do not have any activity, it will start the system Doze timer first if the "Power Management" is not "Disabled". Once the system Doze timer is timed out, it will process doze power saving procedure by starting the system suspend timer. When the suspend timer times out, all of the CPU clock will stop by dropping system clock down to zero and remains this way until any one of the "Enabled" event occurs.

3-5 PNP/PCICONFIGURATION

The PNP/PCI configuration program is for the user to modify the PCI/ISA IRQ signals when various PCI/ISA cards are inserted in the PCI or ISA slots.

WARNING : Any misplacing IRQ could cause system can't pick out the rescouces.

ROM PCI/ISA BIOS(2A5LEPA9) PNP/PCI CONFIGURATION AWARD SOFTWARE, INC.					
PNP OS Installed	:	No	PCI Dynamic Bursting	:	Enabled
Resources Controlled By	:	Manual	PCI Master 0 WS Write	:	Enabled
Reset Configuration Data	:	Disabled	PCI Delay Transaction	:	Enabled
ACPI function	:	Enabled	PCI Master Read Prefetch	:	Enabled
IRQ-3 assigned to	:	Legacy ISA	PCI#2 Access #1 Retry	:	Disabled
IRQ-4 assigned to	:	Legacy ISA	AGP Master 1 WS Write	:	Enabled
IRQ-5 assigned to	:	PCI/ISA PnP	AGP Master 1 WS Read	:	Disabled
IRQ-7 assigned to	:	Legacy ISA			
IRQ-9 assigned to	:	PCI/ISA PnP	PCI IRQ Activied By	:	Level
IRQ-10 assigned to	:	PCI/ISA PnP	Assign IRQ For USB	:	Enabled
IRQ-11 assigned to	:	PCI/ISA PnP	Assign IRQ For VGA	:	Enabled
IRQ-12 assigned to	:	PCI/ISA PnP			
IRQ-14 assigned to	:	Legacy ISA			
IRQ-15 assigned to	:	Legacy ISA			
DMA-0 assigned to	:	PCI/ISA PnP	ESC : Quit	↑ ↓ → ← :	Select Item
DMA-1 assigned to	:	PCI/ISA PnP	F1 : Help	PU/PD/+/- :	Modify
DMA-3 assigned to	:	PCI/ISA PnP	F5 : No Change	(Shift) F2 :	Color
DMA-5 assigned to	:	PCI/ISA PnP	F7 : Load Setup Defaults		
DMA-6 assigned to	:	PCI/ISA PnP			
DMA-7 assigned to	:	PCI/ISA PnP			

Figure3-6PCICONFIGURATIONSETUP

- Resource Controlled By:** The default value is Manual.
Manual: The field defines that the PNP Card's resource is controlled by manual. You can setup whether IRQ-X or DMA-X is assigned to PCI/ISA PNP or Legacy ISA Cards.
Auto: If your ISA card and PCI card are all PNP cards. Set this field to "Auto". The BIOS will assign the interrupt resource automatically.
- Reset Configuration Data:** The default value is Disabled.
Disabled: Normal Setting
Enabled: If you plug some Legacy cards in the system and record into ESCD (Extended System Configuration Data). You can set this field to be Enabled and to clear ESCD at one time, when some Legacy cards are removed.
- PCIIDE IRQ Map To:** The default value is PCI-AUTO.
 When you have true PCI card(s) plugged into the system, you will not need to change any thing here in the **SETUP** program. However, if you do not know whether you are using a true PCI card, please refer to your PCI card user's manual for the details.

When you have a Legacy card (described in section 2-5) to plug into the system, a proper setting is extremely important or it may cause the system hung up. The diagram shown below tells you how the Rotating Priority Mechanism is designed.

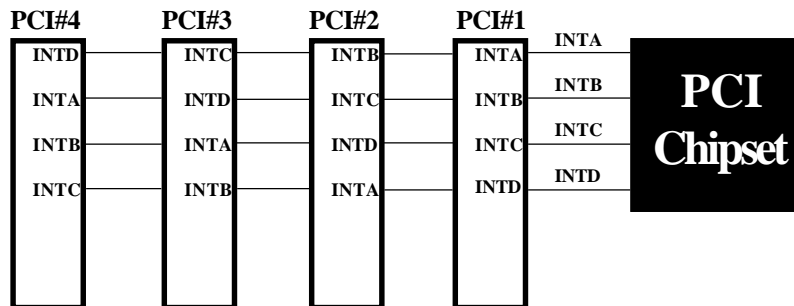

Figure 3-7 The Combination of PCI INT# lines

3-6 INTEGRATED PERIPHERALS

ROM PCI/ISA BIOS(2A5LEPA9) INTEGRATED PERIPHERALS WARD SOFTWARE, INC.			
Onboard Primary PCI IDE	: Enabled	Onboard Parallel Port	: 378/IRQ7
Onboard Secondary PCI IDE	: Enabled	Onboard Parallel Mode	: ECP / EPP
IDE Prefetch Mode	: Enabled	ECP Mode Use DMA	: 3
IDE HDD Block Mode	: Enabled	Parallel Port EPP Type	: EPP1.9
IDE primary Master PIO	: Auto	OnChip USB	: Disabled
IDE Primary Slave PIO	: Auto		
IDE Secondary Master PIO	: Auto		
IDE Secondary Slave PIO	: Auto		
IDE Primary Master UDMA	: Auto		
IDE Primary Slave UDMA	: Auto		
IDE Secondary Master UDMA	: Auto		
IDE Secondary Slave UDMA	: Auto		
PCI IDE Secondary Channel	: Enabled		
Onboard FDD Controller	: Enabled	ESC : Quit	↑ ↓ → ← Select Item
Onboard Serial Port 1	: Auto	F1 : Help	PU/PD/+/- : Modify
Onboard Serial Port 2	: Auto	F5 : No Change	(Shift) F2 : Color
UART 2 Mode	: Standard	F7 : Load Setup Defaults	

Note: If you don't use the Onboard IDE connector, but use On-card (PCI or ISA card) IDE connector. You have to set Onboard Primary PCI IDE: Disabled and Onboard Secondary PCI IDE: Disabled from CHIPSETFEATURESETUPUTILITY. The Onboard PCI IDE cable should be equal to or less than 18 inches (45 cm.).

- IDE HDD Block Mode:** The default value is Enabled.
Enabled : Enabled IDE HDD Block Mode. The HDD transfer rate is better than Disable.
Disabled: Disable IDE HDD Block Mode.
- PCI Slot IDE 2nd Channel:** The default value is Enabled.
Enabled : Enable secondary IDE port and BIOS will assign IRQ15 for this port.
Disabled : Disable secondary IDE port and IRQ15 is available for other device.
- Onboard Primary PCI IDE:** The default value is Enabled.
Enabled : Enable Onboard 1st channel IDE port.
Disabled : Disable Onboard 1st channel IDE port. When use On-card (PCI or ISA card) IDE connector.
- Onboard Secondary PCI IDE:** The default value is Enabled.
Enabled : Enable Onboard 2nd channel IDE port.
Disabled : Disable Onboard 2nd channel IDE port When use On-card (PCI or ISA card) IDE connector.

- **IDE Primary Master PIO:** The default value is Auto.
 - Auto* : BIOS will automatically detect the Onboard Primary Master PCI IDE HDD Accessing mode.
 - Mode0~4* : Manually set the IDE Accessing mode.

- **IDE Primary Slave PIO:** The default value is Auto.
 - Auto* : BIOS will automatically detect the Onboard Primary Slave PCI IDE HDD Accessing mode.
 - Mode0~4* : Manually set the IDE Accessing mode.

- **IDE Secondary Master PIO:** The default value is Auto.
 - Auto* : BIOS will automatically detect the Onboard Secondary Master PCI IDE HDD Accessing mode.
 - Mode0~4* : Manually set the IDE Accessing mode.

- **IDE Secondary Slave PIO:** The default value is Auto.
 - Auto* : BIOS will automatically detect the Onboard Secondary Slave PCI IDE HDD Accessing mode.
 - Mode0~4* : Manually set the IDE Accessing mode.

- **Onboard FDC Controller:** The default value is Enabled.
 - Enabled* : Enable the Onboard floppy drive interface controller.
 - Disabled* : Disable the Onboard floppy drive interface controller, When using On-card ISA FDC's controller.

- **Onboard UART 1:** This field allows the user to select the serial port. The default value is 3F8H/IRQ4.
 - COM1:* Enable Onboard Serial port 1 and address is 3F8H/IRQ4.
 - COM2:* Enable Onboard Serial port 1 and address is 2F8H/IRQ3.
 - COM3:* Enable Onboard Serial port 1 and address is 3E8H/IRQ4.
 - COM4:* Enable Onboard Serial port 1 and address is 2E8H/IRQ3.
 - Disabled:* Disable Onboard Serial port 1.

- **Onboard UART 2:** This field allows the user to select the serial port. The default value is 2F8H/IRQ3.
 - COM1:* Enable Onboard Serial port 2 and address is 3F8H/IRQ4.
 - COM2:* Enable Onboard Serial port 2 and address is 2F8H/IRQ3.
 - COM3:* Enable Onboard Serial port 2 and address is 3E8H/IRQ4.
 - COM4:* Enable Onboard Serial port 2 and address is 2E8H/IRQ3.
 - Disabled:* Disable Onboard Serial port 2.

- **Onboard UART 2 Mode:** The default value is standard. This field allows the User to select the COM2 port that can support a serial Infrared Interface.
Standard: Support a Serial Infrared Interface IrDA.
HPSIR: Support a HP Serial Infrared Interface format.
ASKIR: Support a Sharp Serial Infrared Interface format.
- **Onboard Parallel port:** This field allows the user to select the LPT port. The default value is 378H/IRQ7.
378H : Enable Onboard LPT port and address is 378H and IRQ7
278H : Enable Onboard LPT port and address is 278H and IRQ5.
3BCH : Enable Onboard LPT port and address is 3BCH and IRQ7.
Disabled : Disable Onboard LPT port.

NOTE: Parallel Port address is 378H/3BCH that selects the routing of IRQ7 for LPT1.
Parallel Port address is 278H that selects the routing of IRQ5 for LPT1.

- **Parallel port Mode:** This field allows the user to select the parallel port mode. The default value is ECP+EPP. The
Normal : Standard mode. IBM PC/AT Compatible bidirectional parallel port.
EPP : Enhanced Parallel Port mode.
ECP : Extended Capability Port mode.
EPP+ECP : ECP Mode & EPP Mode.
- ECP Mode USE DMA:** This field allows the user to select DMA1 or DMA3 for the ECP mode. The default value is DMA3.
- DMA1** : The field selects the routing of DMA1 for the ECP mode.
 - DMA3** : The field selects the routing of DMA3 for the ECP mode.

3-7 LOAD SETUP DEFAULTS

The "LOAD SETUP DEFAULTS" function loads the system default data directly from ROM and initializes the associated hardware properly. This function will be necessary only when the system CMOS data is corrupted.

3-9 IDE HDD AUTO DETECTION

The "IDE HDD AUTO DETECTION" utility is a very useful tool especially when you do not know which kind of hard disk type you are using. You can use this utility to detect the correct disk type installed in the system automatically. **But now** you can set **HARD DISK TYPE** to **Auto** in the **STANDARD CMOS SETUP**. You do not need the "IDE HDD AUTO DETECTION" utility. The BIOS will Auto-detect the hard disk size and model on display during POST.

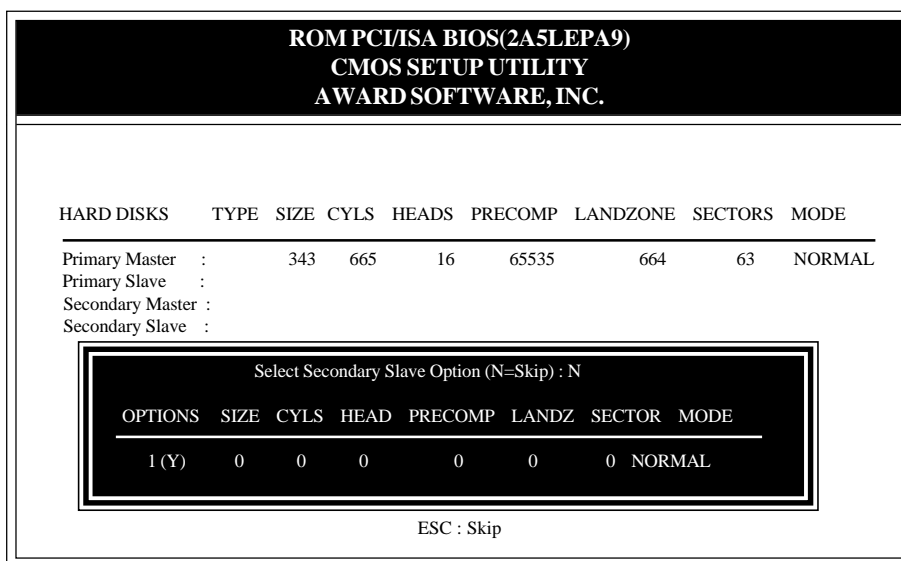

Figure 3-9 IDE HDD AUTO DETECTION

NOTE: HDD Modes

The Award BIOS supports 3 HDD modes : NORMAL, LBA and LARGE NORMAL mode.

Generic access mode that is neither the BIOS nor the IDE controller will make transformations during accessing.

The maximum numbers of cylinders, head & sectors for NORMAL mode are 1024, 16 and 63.

$$\begin{array}{r}
 \text{no. Cylinder} \quad (1024) \\
 \times \text{ no. Head} \quad (16) \\
 \times \text{ no. Sector} \quad (63) \\
 \hline
 \times \text{ no. per sector} \quad (512) \\
 \hline
 528 \text{ Megabytes}
 \end{array}$$

If an user sets the HDD to NORMAL mode, the maximum accessible HDD size will be 528 Megabytes even though its physical size may be greater than that!

LBA (Logical Block Addressing) mode: This is a new HDD accessing method to overcome the 528 Megabyte bottleneck.

The number of cylinders, heads and sectors shown in the setup may not be the number physically contained in the HDD.

During the HDD accessing, the IDE controller will transform the logical address described by sector, head and cylinder into its own physical address inside the HDD.

The maximum HDD size supported by LBA mode is 8.4 Gigabytes which is obtained by the following formula:

$$\begin{array}{r}
 \text{no. Cylinder} \quad (1024) \\
 \times \text{ no. Head} \quad (255) \\
 \times \text{ no. Sector} \quad (63) \\
 \hline
 \times \text{ bytes per sector} \quad (512) \\
 \hline
 8.4 \text{ Gigabytes}
 \end{array}$$

LARGE mode: This is an extended HDD access mode supported by Award Software.

Some IDE HDDs contain more than 1024 cylinders without LBA support (in some cases, user does not want LBA). The Award BIOS provides another alternative to support these kinds of LARGE mode:

<u>CYLS.</u>	<u>HEADS</u>	<u>SECTOR</u>	<u>MODE</u>
1120	16	59	NORMAL
560	32	59	LARGE

BIOS tricks DOS (or other OS) that the number of cylinders is less than 1024 by dividing it by 2. At the same time, the number of heads is multiplied by 2. A reverse transformation process will be made inside INT 12h in order to access the right HDD address

Maximum HDD size:

$$\begin{array}{r}
 \text{no. Cylinder} \quad (1024) \\
 \times \text{ no. Head} \quad (32) \\
 \times \text{ no. Sector} \quad (63) \\
 \hline
 \times \text{ bytes per sector} \quad (512) \\
 \hline
 1 \text{ Gigabytes}
 \end{array}$$

Note:

To support LBA or LARGE mode of HDDs, there must be some softwares involved. All softwares are located in the Award HDD Service Routine (1NT 13h). It may fail to access a HDD with LBA (LARGE) mode selected if you are running under on Operating System which replaces the whole 1NT 13h. UNIX operating systems do not support either LBA or LARGE and must utilize the Standard mode. UNIX can support drives larger than 528MB.

3-10 HDD LOW LEVEL FORMAT

Interleave

Select the interleave number of the hard disk drive that you wish to perform a low level format on. You may select from 1 to 8. Check the documentation that came with the drive for the correct interleave number, or select 0 for automatic detection.

Auto scan bad track

This allows the utility to scan first then format by each track.

Start

Press<Y>to start low level format.

3-11 SAVE & EXIT SETUP

The "SAVE & EXIT SETUP" option will bring you back to boot up procedure with all the changes you just recorded in the CMOS RAM.

3-12 EXIT WITHOUT SAVING

The "EXIT WITHOUT SAVING" option will bring you back to normal boot up procedure without saving any data into CMOS RAM. All old data in the CMOS will not be destroyed.

Chapter 4

Technical Information

4-1 I/O & MEMORY MAP

MEMORYMAP

Address Range	Size	Description
[0000-7FFFF]	512K	Conventional memory
[8000-9FBFF]	127K	Extended Conventional memory
[9FC00-9FFFF]	1K	Extended BIOS data area if PS/2 mouse is installed
[A0000-C7FFF]	160K	Available for Hi DOS memory
[C8000-DFFFF]	96K	Available for Hi DOS memory and adapter ROMs
[E0000-EEFFF]	60K	Available for UMB
[EF000-EFFFF]	4K	Video service routine for Monochrome & CGA adaptor
[F0000-F7FFF]	32K	BIOS CMOS setup utility
[F8000-FCFFF]	20K	BIOS runtime service routine (2)
[FD000-FDFFF]	4K	Plug and Play ESCD data area
[FE000-FFFFF]	8K	BIOS runtime service routine (1)

I/OMAP

[000-01F]	DMA controller.(Master)
[020-021]	INTERRUPT CONTROLLER.(Master)
[022-023]	CHIPSET control registers. I/O ports.
[040-05F]	TIMER control registers.
[060-06F]	KEYBOARD interface controller.(8042)
[070-07F]	RTC ports & CMOS I/O ports.
[080-09F]	DMA register.
[0A0-0BF]	INTERRUPT controller.(Slave)
[0C0-0DF]	DMA controller.(Slave)
[0F0-0FF]	MATH COPROCESSOR.
[1F0-1F8]	HARD DISK controller.
[278-27F]	PARALLEL port 2.
[2B0-2DF]	GRAPHICS adapter controller.
[2F8-2FF]	SERIAL port 2.
[360-36F]	NETWORK ports.
[378-37F]	PARALLEL port 1.
[3B0-3BF]	MONOCHROME & PARALLEL port adapter.
[3C0-3CF]	EGA adapter.
[3D0-3DF]	CGA adapter.
[3F0-3F7]	FLOPPY DISK controller.
[3F8-3FF]	SERIAL port 1.

4-4 RTC & CMOS RAM MAP

RTC & CMOS :	00	Seconds.
	01	Second alarm.
	02	Minutes.
	03	Minutes alarm.
	04	Hours.
	05	Hours alarm.
	06	Day of week.
	07	Day of month.
	08	Month.
	09	Year.
	0A	Status register A.
	0B	Status register B.
	0C	Status register C.
	0D	Status register D.
	0E	Diagnostic status byte.
	0F	Shutdown byte.
	10	FLOPPY DISK drive type byte.
	11	Reserve.
	12	HARD DISK type byte.
	13	Reserve.
	14	Equipment type.
	15	Base memory low byte.
	16	Base memory high byte.
	17	Extension memory low byte.
	18	Extension memory high byte.
	19-2d	
	2E-2F	
	30	Reserved for extension memory low bytw.
	31	Reserved for extension memory high byte.
	32	DATE CENTURY byte.
	33	INFORMATIONFLAG.
	34-3F	Reserve.
	40-7F	Reserved for CHIPSET SETTING DATA.

APPENDIX A: POST CODES

ISA POST codes are typically output to port address 80h.

POST(hex) DESCRIPTION

01-02	Reserved.
C0	Turn off OEM specific cache, shadow.
03	<ol style="list-style-type: none"> 1.Initialize EISA registers (EISA BIOS only). 2.Initialize all the standard devices with default values Standard devices includes. <ul style="list-style-type: none"> -DMA controller (8237). -Programmable Interrupt Controller (8259). -Programmable Interval Timer (8254). -RTC chip.
04	Reserved
05	<ol style="list-style-type: none"> 1.Keyboard Controller Self-Test. 2.Enable Keyboard Interface.
06	Reserved.
07	Verifies CMOS's basic R/W functionality.
C1	Auto-detection of onboard DRAM & Cache.
C5	Copy the BIOS from ROM into E0000-FFFFF shadow RAM so that POST will go faster.
08	Test the first 256K DRAM.
09	OEM specific cache initialization. (if needed)
0A	<ol style="list-style-type: none"> 1.Initialize the first 32 interrupt vectors with corresponding Interrupt handlers Initialize INT no from 33-120 with Dummy (Suprious) Interrupt Handler. 2.Issue CPUID instruction to identify CPU type. 3.Early Power Management initialization. (OEM specific)
0B	<ol style="list-style-type: none"> 1.Verify the RTC time is valid or not. 2.Detect bad battery. 3.Read CMOS data into BIOS stack area. 4.PnP initializations including. (PnP BIOS only) <ul style="list-style-type: none"> -Assign CSN to PnP ISA card. -Create resource map from ESCD. 5.Assign IO & Memory for PCI devices. (PCI BIOS only)

POST(hex) DESCRIPTION

0C	Initialization of the BIOS Data Area. (40:00 - 40:FF)
0D	<ol style="list-style-type: none"> 1.Program some of the Chipset's value according to Setup. (Early Setup Value Program) 2.Measure CPU speed for display & decide the system clock speed. 3.Video initialization including Monochromc, CGA, EGA/VGA. If no display device found, the speaker will beep.
0E	<ol style="list-style-type: none"> 1.Test video RAM. (If Monochromc display device found) 2.Show messages including. <ul style="list-style-type: none"> -Award Logo, Copyright string, BIOS Data code & Part No. -OEM specific sign on messages. -Energy Star Logo. (Green BIOS ONLY) -CPU brand, type & speed. -Test system BIOS checksum. (Non-Compress Version only)
0F	DMA channel 0 test.
10	DMA channel 1 test.
11	DMA page registers test.
12-13	Reserved.
14	Test 8254 Timer 0 Counter 2.
15	Test 8259 interrupt mask bits for channel 1.
16	Test 8259 interrupt mask bits for channel 2.
17	Reserved.
19	Test 8259 functionality.
1A-1D	Reserved.
1E	If EISA NVM checksum is good, exccute EISA initialization. (EISA BIOS only)
1F-29	Reserved.
30	Detect Base Memory & Extended Memory Size.
31	<ol style="list-style-type: none"> 1.Test Base Memory from 256K to 640K. 2.Test Extended Memory from 1M to the top of memory.

POST(hex) DESCRIPTION

32	1.Display the Award Plug & Play BIOS Extension message. (PnP BIOS only) 2.Program all onboard super I/O chips (if any) including COM ports, LPT ports, FDD port ... according to setup value.
33-3B	Reserved.
3C	Set flag to allow users to enter CMOS Setup Utility.
3D	1.Initialize Keyboard. 2.Install PS2 mouse.
3E	Try to turn on Level 2 cache. Note : Some chipset may need to turn on the L2 cache in this stage. But usually, the cache is turn on later in POST 61h.
3F-40	Reserved.
BF	1.Program the rest of the Chipset's value according to Setup. (Later Setup Value Program) 2.If auto-configuration is enabled, programmed the chipset with pre-defined Values.
41	Initialize floppy disk drive controller.
42	Initialize Hard drive controller.
43	If it is a PnP BIOS, initialize serial & parallel ports.
44	Reserved.
45	Initialize math coprocessor.
46-4D	Reserved.
4E	If there is any error detected (such as video, kb...), show all the error messages on the screen & wait for user to press <F1> key.
4F	1.If password is needed, ask for password. 2.Clear the Energy Star Logo. (Green BIOS only)
50	Write all CMOS values currently in the BIOS stack area back into the CMOS.
51	Reserved.

POST(hex) DESCRIPTION

- 52** 1.Initialize all ISA ROMs.
 2.Later PCI initializations. (PCI BIOS only)
 -assign IRQ to PCI devices.
 -initialize all PCI ROMs.
 3.PnP Initializations. (PnP BIOS only)
 -assign IO, Memory, IRQ & DMA to PnP ISA devices.
 -initialize all PnP ISA ROMs.
 4.Program shadows RAM according to Setup settings.
 5.Program parity according to Setup setting.
 6.Power Management Initialization.
 -Enable/Disable global PM.
 -APM interface initialization.
- 53** 1.If it is NOT a PnP BIOS, initialize serial & parallel ports.
 2.Initialize time value in BIOS data area by translate the RTC time value into a timer tick value.
- 60** Setup Virus Protection. (Boot Sector Protection) functionality according to Setup setting.
- 61** 1.Try to turn on Level 2 cache.
 Note : if L2 cache is already turned on in POST 3D, this part will be skipped.
 2.Set the boot up speed according to Setup setting.
 3.Last chance for Chipset initialization.
 4.Last chance for Power Management initialization. (Green BIOS only)
 5.Show the system configuration table.
- 62** 1.Setup daylight saving according to Setup value.
 2.Program the NUM Lock, typematic rate & typematic speed according to Setup setting.
- 63** 1.If there is any changes in the hardware configuration, update the ESCD information. (PnP BIOS only)
 2.Clear memory that have been used.
 3.Boot system via INT 19H.
- FF** System Booting. This means that the BIOS already pass the control right to the operating system.

Unexpected Errors:

POST(hex) DESCRIPTION

- B0** If interrupt occurs in protected mode.
- B1** Unclaimed NMI occurs.

APPENDIX B: I/O CONNECTORS

J1 : PS/2 MOUSE CONNECTOR:

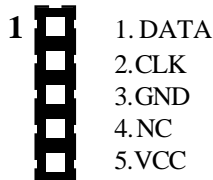

CN1 : USB CONNECTOR:

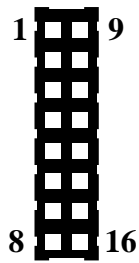

Signal Name	Pin	Pin	Signal Name
USB_VCC	1	9	Ground
USB_data0-	2	10	Ground
USB_data0+	3	11	Ground
Ground	4	12	Ground
USB_VCC	5	13	Ground
USB_data1-	6	14	Ground
USB_data1+	7	25	Ground
Ground	8	26	Ground

COM1,COM2 : Serial Ports Connector

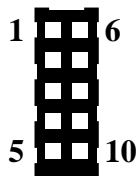

Signal Name	Pin	Pin	Signal Name
DCD	1	6	DSR
SIN	2	7	RTS
SOUT	3	8	CTS
DTR	4	9	RI
GND	5	10	N.C.

LPT1 : Parallel Port Connector

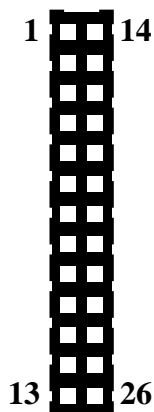

Signal Name	Pin	Pin	Signal Name
STROBE-	1	14	AUTO FEED-
Data Bit 0	2	15	ERROR-
Data Bit 1	3	16	INIT-
Data Bit 2	4	17	SLCT IN-
Data Bit 3	5	18	Ground
Data Bit 4	6	19	Ground
Data Bit 5	7	20	Ground
Data Bit 6	8	21	Ground
Data Bit 7	9	22	Ground
ACJ-	10	23	Ground
BUSY	11	24	Ground
PE	12	25	Ground
SLCT	13	26	N.C.

FDD1 : Floppy Disk Connector

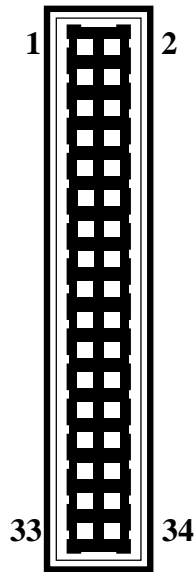

Signal Name	Pin	Pin	Signal Name
Ground	1	2	FDHDIN
Ground	3	4	Reserved
Ground	5	6	FDEDIN
Ground	7	8	Index-
Ground	9	10	Motor Enable
Ground	11	12	Drive Select B-
Ground	13	14	Drive Select A-
Ground	15	16	Motor Enable
Ground	17	18	DIR-
Ground	19	20	STEP-
Ground	21	22	Write Data
Ground	23	24	Write Gate
Ground	25	26	Track 00-
Ground	27	28	Write Protect-
Ground	29	30	Read Data-
Ground	31	32	SIDE 1 SELECT-
Ground	33	34	Diskette

IDE1,IDE2 : Primary,Secondary IDE Connector

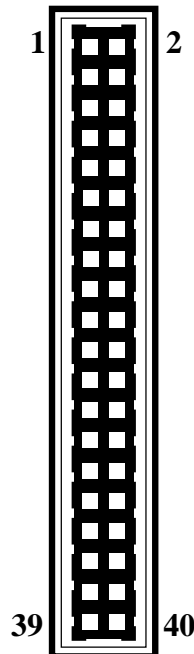

Signal Name	Pin	Pin	Signal Name
Reset IDE	1	2	Ground
Host Data 7	3	4	Host Data 8
Host Data 6	5	6	Host Data 9
Host Data 5	7	8	Host Data 10
Host Data 4	9	10	Host Data 11
Host Data 3	11	12	Host Data 12
Host Data 2	13	14	Host Data 13
Host Data 1	15	16	Host Data 14
Host Data 0	17	18	Host Data 15
Ground	19	20	Key
DRQ3	21	22	Ground
I/O Write-	23	24	Ground
I/O Read-	25	26	Ground
IOCHRDY	27	28	BALE
DACK3-	29	30	Ground
IRQ14	31	32	IOCS16-
Addr 1	33	34	Ground
Addr 0	35	32	Addr 2
Chip Select 0-	37	38	Chip Select 1-
Activity	39	40	Ground

Appendix C : AGP Driver for Windows 95 Installation Guide

This section provides the information for installation of Apollo VP3 VxD Driver which supports Accelerated Graphics Port (AGP) functionalities.

SYSTEM REQUIREMENTS

1. Microsoft Windows 95 OSR2.1 (OSR2.0 with USB upgrade)
2. VIA Apollo VP3 AGP Driver (Vgart.VXD)
3. AGP VGA Card with Driver
4. Direct X5 DDK or SDK

INSTALLATION PROCEDURE

- Step 1. Install Windows 95 4.00.950 B or later version
- Step 2. Install USBSUPP (USB upgrade)
- Step 3. Install Apollo VP3 AGP Driver
 - run the program "SETUP.EXE" which can be found in the VIA VxD driver disk and this process will then automatically install the VIA VxD driver onto your windows 95 system.
- Step 4. Install VGA driver for Windows 95
- Step 5. Install Microsoft Direct X5 DDK or SDK

NOTES

1. This driver should be installed on a system with the VIA Apollo VP3 AGP chipset while other chipsets is not be supported. The VIA VxD Driver is only supported by Windows 95 OSR 2.0 (4.00.950 B) ro later versions.
2. For Win95 users, you will need to
 - a. Get "USBSUPP.EXE" from Microsoft (www.microsoft.com), which includes the USB supplement and a new memory manager (VMM32.VxD) needed for the AGP DIME (Direct Memory Execute) feature.
 - b. Get DirectX 5.0 from Microsoft (www.microsoft.com). DirectX 5.0 is the first DirectX version that supports AGP's DIME.
 - c. Get "VIAGART.VXD", a virtual device manager which is usually installed during the installation procedure of the Windows 95 card driver.
3. To make sure if the Apollo VP3 AGP driver is properly installed, one must boot the Windows 95 system up and run "Regedit" and check whether the file VIAGART exists in the following path
"HKEY_LOCAL_MACHINE\System\CurrentControlSet\Services\VxD"
4. To check whether the AGP driver is able to activate, one must do the following:
 - a. Activate the "Control Panel"

- b. Click on "Direct X" then
- c. Click on "Direct Draw" and
- d. Check if there are some values existing in the "Bit" and "overlays."
if there is, that means the AGP can be activated properly.

REPLACING AN EXISTING VGA CARD WITH THE AGP VGA CARD

1. Shut down the computer and then turn off the power
2. Replace the VGA card boot up the system once again
3. Now, Update Device Driver Wizard Window will appear. This wizard will complete the installation of the Standard PCI Graphics Adapter (VGA).
Click Next > to let Windows search for an updated driver.

WARNING ! Only click Next >. The system will hang if you click Cancel!

4. Click Finish to install the VGA driver. You will then be asked for your Windows 95 CD in order to complete the VGA driver installation. If you do not have your CD handy, direct the installation path to your \windows\system directory. Windows will prompt you to restart your windows. Chose "NO" and install the appropriate AGP VGA Driver