

SENSOR Nederland b.v.

SMT-200 v2.00

Operations and Technical Manual



Page intentionally left blank



CERTIFICATION

SENSOR Nederland b.v. - INPUT/OUTPUT INC. certifies that this instrument meets its published specifications at the time of shipment from the factory.

WARRANTY AND ASSISTANCE

This INPUT/OUTPUT INC. product is warranted against defects in materials and workmanship for a period of **SIX** months from the date of shipment. INPUT/OUTPUT INC. will, at its option, repair or replace a product which proved to be defective during the warranty period, provided it is returned to an INPUT/OUTPUT INC. office and providing the proper preventative maintenance procedures as listed in this manual are followed. Repairs necessitated by misuse of the product are not covered by this warranty.

NO OTHER WARRANTIES ARE EXPRESSED OR IMPLIED INCLUDING, BUT NOT LIMITED TO, THE IMPLIED WARRANTIES OF MERCHANTABILITY AND FITNESS FOR A PARTICULAR PURPOSE. IN NO EVENT SHALL INPUT/OUTPUT INC. BE LIABLE FOR ANY INCIDENTAL OR CONSEQUENTIAL DAMAGES RESULTING FROM THE USE OF THE PRODUCT OR CAUSED BY ANY DEFECT, FAILURE, OR MALFUNCTION OF THE PRODUCT, WHETHER A CLAIM FOR SUCH DAMAGE IS BASED UPON WARRANTY, CONTRACT, NEGLIGENCE OR OTHERWISE.

SOFTWARE LICENSE

ATTENTION: USE OF THE SOFTWARE IS SUBJECT TO THE I/O SOFTWARE LICENSE TERMS SET FORTH IN THE INPUT/OUTPUT MASTER SOFTWARE LICENSE AGREEMENT. USING THE SOFTWARE INDICATES YOUR ACCEPTANCE OF THESE TERMS. IF YOU DO NOT ACCEPT THESE TERMS, YOU MAY RETURN THE SOFTWARE FOR A FULL REFUND. IF THE SOFTWARE IS SUPPLIED WITH ANOTHER PRODUCT, YOU MAY RETURN THE ENTIRE UNUSED PRODUCT FOR A FULL REFUND. YOUR RIGHT TO RETURN AND REFUND EXPIRES 30 DAYS AFTER PURCHASE FROM I/O OR AN I/O DISTRIBUTOR. THE RIGHT TO RETURN AND REFUND DOES NOT EXTEND TO YOUR TRANSFEREE.

The following terms govern your use of the enclosed software unless you have a separate Input/Output master software license agreement in place.

LICENSE Grant- I/O grants you a license to use one copy of the version of the software (identified in your documentation) on any one hardware product. "You" means the company, entity or individual whose funds are used to pay the license fee. "Use" means storing, loading, installing, executing or displaying the software. You may not modify the software or disable any licensing or control features of the software except as an intended part of the software's programming features

Ownership- The software is owned and copyrighted by I/O. Your license confers no title or ownership in the software and should not be construed as a sale of any right in the software. I/O's third party suppliers may protect their rights in the event of any violation of these terms.

Copies and Adaptations- You may only make copies or adaptations of the software for archival purposes or when copying or adaptation is an essential step in the authorised use of the software. You must reproduce all copyright notices in the original software on all authorised copies or adaptations. You may not copy the Software onto any bulletin board or similar system.

No Disassembly or Decryption- You may not disassemble, decompile or decrypt the software unless I/O's prior written consent is obtained. In some jurisdictions, I/O's consent may not be required for disassembly or decompilation. Upon request, you will provide I/O with reasonable detailed information regarding any disassembly or decompilation.

Transfer- Your license will automatically terminate upon any transfer of the software. Upon transfer, you must deliver the original and all complete, partial or electronically stored copies of the software and related documentation to the transferee. The transferee must accept these terms as a condition to the transfer.

Termination- I/O may terminate your license upon notice for failure to comply with any of these terms. Upon termination, you must immediately destroy the software together with all copies, adaptations and merged portions in any form.

Export Requirements- You may not export or re-export the software or any copy or adaptation in violation of any applicable laws or regulations.

Year 2000 Compliance

covering electronic equipment and software produced by



SMT-100

Transfer Program
Reader Program

The hardware and software used in the '**SMT-100 Geophone Tester**' and '**SMT-100 Fieldbox**' (model I and II) does not utilise a real-time clock and is therefore immune from problems associated with the year 2000 issue. The date (that can be manually set in the header of the printout) will accept the year 2000 and higher. Also the associated '**SMT-100 Module Reader**' and RS232 data transfer '**SMT-100 Xfer**' programs (both version 1.84 and higher) will accept dates beyond 31 December 1999.

See Note

SMT-150

The SMT-150 hardware and associated '**SMT-150 Geophone Tester**' program (version 1.84 and higher) will accept dates beyond 31 December 1999.

See Note

SMT-200

(Docking Station)

The SMT-200 hardware and software (version 1.89 and higher) and associated '**SMT-200DS Docking Station**' program (version 1.89 and higher) are year 2000 compliant. Please note that during data transfer from or to the PC and during updates of the SMT-200 program, the time and date of the SMT-200 is synchronised with the time and date of the host PC.

* To prevent possible date conflicts it is strongly recommended to attach the SMT-200 only to PC's that are year 2000 compliant.

* To prevent possible update problems never update the SMT-200 software from a PC that is not year 2000 compliant.

Note

The hardware and software has been tested on PC's that are year 2000 compliant. Other than date and time stamp errors on files saved to PC's that are not year 2000 compliant, there are no other problems expected when connected to PCs that are not year 2000 compliant.

 **SENSOR** can not be held responsible for the malfunction of the above programs or loss of data when used on PC's that are not year 2000 compliant.

Please contact one of our sales offices in case you encounter any problem.



SENSOR has adopted the BSI-DISC definition of 'Year 2000 Conformity':

"Neither performance nor functionality is affected by dates prior to, during and after the year 2000"

Table of Contents

Page

SECTION 1 INTRODUCTION

1

1.1	Introduction	3
1.2	Technical Support	3
1.3	Overview	4
1.4	Specifications	4
1.5	Packaging information	5
1.6	Before use...	6
1.6.1	Voltage selection	6
1.6.2	Battery charging	6

SECTION 2 SMT-200 OPERATIONS

7

2.1	SMT-200 Layout	9
2.2	Switching on the SMT-200	9
2.2.1	Post Mortem on Powering up	10
2.3	Navigating around the screens	10
2.4	Switching off the SMT-200	13
2.5	Battery level	14
2.6	Battery level Jumper setting	15
2.7	Menu flowchart	16
2.8	Main menu <i>The main menu allows access to all functions of the SMT-200</i>	19
2.9.1	Do a test <i>Select this option to initiate a test sequence on a string</i>	19
2.10.2	Setup menu <i>Allows customisation of the SMT-200 operating and test parameters</i>	20
2.11.2.1	String menu <i>Set the string geometry and leader parameters</i>	20
2.12.2.1.9	Limits menu <i>Sets maximum allowable limits for various tests</i>	21
2.13.2.2	Geophone menu <i>Selects and modifies if required the type of geophone element used</i>	21
2.14.2.2.1	Select menu <i>Selects the type of geophone element used</i>	22
2.15.2.2.2	Edit <i>Edit the geophone parameters</i>	22
2.16.2.2.3	Copy <i>Copy existing element description to a new geophone type</i>	22
2.16.2.2.4	Delete <i>Deletes an existing element description</i>	22
2.17.2.3	Operating menu <i>General options for string testing</i>	23
2.18.2.4	Tests Sequence <i>Selects the tests to be performed on the string</i>	24
2.19.2.5	Display menu <i>Customises display, keypad and sound options</i>	24
2.20.2.7	Power menu <i>Selects the various power saving options</i>	25
2.21.2.8	Date & Time <i>Sets the SMT-200 clock</i>	25
2.22.2.9	Diagnostics <i>Runs the diagnostics and calibration routines</i>	26
2.23.3	Temp. menu <i>Read or set the external temperature and temperature options</i>	28
2.24.4	File menu <i>Internal file handling and data / code transfer options</i>	30
2.25.4.1	Redisplay Last <i>Shows the result of the last test run</i>	30
2.26.4.2	Storage Status <i>Indicates the internal memory storage</i>	31
2.27.4.3	Dump data file <i>Transfer contents of data file to COM port</i>	31
2.28.4.4	List data file <i>List contents of data file</i>	32
2.29.4.5	Erase data <i>Clears contents of data file</i>	32
2.30.4.6	Read Config <i>Loads the stored configuration file</i>	33
2.31.4.7	Save Config <i>Saves the configuration file</i>	33
2.32.6	About <i>Provides general information about the SMT-200</i>	34



SECTION 3 DOCKING STATION & PC SOFTWARE OPERATIONS	35
3.1 Docking Station overview	37
3.2 Docking Station interconnection	37
3.2.1 Battery Charging	38
3.2.2 PC Interface	38
3.3 Docking Station PC software introduction	39
3.4 Software installation	39
3.5 Windows installation	39
3.5.1 Windows un-install	40
3.6 DOS installation	40
3.6.1 DOS un-install	40
3.7 Running the program	41
3.7.1 SMT-200DS menu	42
3.7.2 File menu	42
3.7.3 SMT-200 menu	42
3.8 Data Exchange	43
3.8.1 Instructions for File Transfer	43
3.8.2 Explanation of Data transfer sequence:	43
3.8.3 The SMT-200 During File Transfer	44
3.8.4 Failing Transfers	44
3.9 System Update	45
3.9.1 Instructions for System Update	45
3.9.2 Failing System Updates	45
3.10 The SMT-200 Geophone Specifications File	45
SECTION 4 RFID TAG READER	47
4.1 RFID Tag reader introduction	49
4.2 Principles of the RFID Tag reader	49
4.3 Working with the RFID Tag reader	50
4.3.1 Read tags	50
4.3.2 Test the strings	51
4.3.3 Transfer data file	52
4.4 Sorting the tag list	53
4.4.1 Download the tag list to the PC	53
4.4.2 Upload the tag list to the SMT-200	53
4.4.3 View the tag list on the SMT-200	55
4.4.4 View the tag list on the PC	55
4.5 Settings	57
4.5.1 COM settings	57
4.5.2 Autonumber	57
4.5.3 Tag menu visible	57
4.6 Internal storage	58
SECTION 5 GEOPHONE TESTING	59
5.1 Preparing the SMT-200 for use	61
5.2 Testing a string	63
5.3 Downloading data to a PC	64
5.3.1 Data File Test codes	65
5.3.2 Data File Reject codes	65
5.4 Basic Geophone Troubleshooting <i>using the continuous impedance test</i>	66
5.5 Isolation Table	69

SECTION 6 SMT-200 TECHNICAL	71
6.1 SMT-200 Description	73
6.2 PC/104 Description	73
6.3 PC/104 Connector and Jumper Locations	74
6.4 SMT-200 Main Board block diagram	75
6.5 Power Supply	76
6.6 Address Decoder	76
6.7 Display	76
6.8 Keyboard	77
6.9 Digital to Analogue Converter	77
6.10 Filter	78
6.11 Geophone Circuit	78
6.12 Analogue to Digital Converter	78
6.13 SMT-200 Interconnection	79
SECTION 7 DOCKING STATION TECHNICAL	81
7.1 Docking Station Block Diagram	83
7.2 PC Interface	84
7.3 Battery Charging	84
APPENDIX A CONNECTOR PIN OUTS	87
A.1 SMT-200 Bendix Connector	89
A.2 Docking Station SMT-200 Connector	89
A.3 Docking Station External Smartec Connector	90
A.4 Docking Station PC Connector	90
A.5 Smartec Temperature Sensor	91
A.6 SMT-200 to Docking Station Cable	92
APPENDIX B TEST OVERVIEW	93
B.1 Geophone Basics	95
B.2 Polarity Test	95
B.3 Noise Test	96
B.4 Leakage Test	96
B.5 Resistance Test	97
B.6 Pulse Test	97
B.7 Distortion Test	99
B.8 Distortion test drive mode	100
B.9 Continuous Impedance	100
B.10 Low Drive Continuous Impedance	100
B.11 Geophone String Resistance Calculation	101
B.11.1 Series String	101
B.11.2 Series Parallel String	101
B.12 Damping Calculations	102
B.13 Temperature Compensation	102
APPENDIX C PARTS LIST	103
C.1 SMT-200 Geophone Tester	105



C.2	SMT-200 Battery Pack	109
C.3	SMT-200 Docking Station	110
C.4	SMT-200 Accessories and Cables	112
APPENDIX D SCHEMATICS & LAYOUTS		113
D.1	SMT-200 Schematics	115
D.1.1	SMT-200 Geophone Tester	115
D.1.2	SMT-200 ADC	116
D.1.3	SMT-200 Filter	117
D.1.4	SMT-200 Keyboard	118
D.1.5	SMT-200 DAC	119
D.1.6	SMT-200 Geophone Circuit	120
D.1.7	SMT-200 Power	121
D.1.8	SMT-200 Display	122
D.2	SMT-200 Component Layout (SMT-200.7 01/98)	123
D.3	SMT-200 Docking Station Schematics	124
D.3.1	SMT-200 Docking Station / Charger	124
D.3.2	UC3906-B1	125
D.3.3	UC3906-B2	126
D.4	SMT-200 Component Layout (SMT-200.7 CHARGER 01/98)	127
APPENDIX E QUICK REFERENCE		129
E.1	Quick Reference	131
APPENDIX F ADDENDUM		135
F.1	Addendum	137
INDEX		139

Table of terms

Symbol	Denotation
%	Percent
Ω	Ohm
°C	Degrees Centigrade
°F	Degrees Fahrenheit
Bo	Open circuit damping
Bc	Coil damping
Bt	Total damping
FFT	Fast Fourier Transfer
Fn	Natural frequency
Go	Open circuit sensitivity
Hz	Hertz
Kg.	Kilogram
Lbs.	Pounds
M	Suspended mass
mm	Millimeters
m	Meters
MB	Mega byte
Rc	Coil resistance
Rs	Shunt resistance
Rt	Total geophone resistance
V	Volts
v	Software version
V/in/s	Volts per inch per second
V/m/s	Volts per meter per second
VAC	Volts alternating current



Section 1

Introduction

Page intentionally left blank

1.1 Introduction

These instructions are intended as a guideline for the operation of the SMT-200 Geophone Tester. Should problems be found that cannot be answered by these notes please call your nearest I/O Sensor Technical Support location for assistance.

The availability of future software upgrades will be made known to SMT-200 users via the i-o web site.

Your comments regarding the convenience of operation of the unit, its performance, any problems you have experienced and any features that would be useful or are in your opinion essential, would be greatly appreciated for the future development of this product.

The software provided with this tester is proprietary and may not be copied without prior consent having been obtained from Sensor Nederland b.v.

1.2 Technical Support

Further information and assistance can be obtained by calling one of the following I/O SENSOR Technical Support locations:

EUROPE	USA & CANADA
Sensor Nederland bv. Rouwkooplaan 8 2251 AP Voorschoten Holland	Input/Output 11104 West Airport Stafford Texas 77477 USA
Tel. +31 (0)71 5601234 Fax. +31 (0)71 5617145	Tel. +1 281 879 2130 Fax. +1 281 879 3500
<i>Contact and e-mail address:</i>	<i>Contact and e-mail address</i>
Steve Burden (sburden@i-o.com) Kees Faber (kfaber@i-o.com)	Scott Williams (swilliam@i-o.com) Pete Maxwell (pmaxwell@i-o.com)

See our web site at **www.i-o.com** for SMT-200 updates, geophone specifications and information on other I/O products.

1.3 Overview

The SMT-200 is the latest addition to the Sensor range of geophone testing equipment. Due to the advanced technology used in the design it has all the features of previous generation testing equipment in a smaller and more compact unit. Its easy to use menu system allows the SMT-200 to be quickly configured to test virtually any type of geophone string. Internal automatic calibration eliminates the need for regular maintenance.

The Docking station is provided to manage battery charging and communication between the SMT-200 and the PC.

The SMT-200 can be operated from lead-acid gel batteries (2 supplied) or connected to the docking station for file transfer. The battery pack will supply enough power for 4 hours heavy field use.

1.4 Specifications

Natural Frequency

<i>Range</i>	1 to 100Hz
<i>Accuracy</i> < 8Hz	± 2% of measured value or 0.1Hz whichever is the greater
8Hz - 14Hz	± 0.5% of measured value or 0.05Hz whichever is the greater
>14Hz	± 1% of measured value
<i>Display Resolution</i>	0.01Hz

Coil Resistance

<i>Range</i>	20 to 9999 ohm
<i>Accuracy</i>	± 1% or 1 ohm whichever is the greater
<i>Display Resolution</i>	1 ohm or 0.1 ohm when measured value is less than 100 ohm

Damping

<i>Range</i>	0.100 to 0.850
<i>Accuracy</i>	± 1% of measured value
<i>Display Resolution</i>	0.001

Sensitivity

<i>Range</i>	0 to 999 V/m/s
<i>Accuracy</i>	± 2% Calculated from other measured values
<i>Display Resolution</i>	0.1 V/m/s

Harmonic Distortion

<i>Range</i>	0 to 20 %
<i>Accuracy</i>	± 10% of measured value or 0.01% whichever is greater
<i>Display Resolution</i>	0.01%

Dynamic Resistance

<i>Range</i>	20 to 99999 ohm
<i>Accuracy</i>	Not specified

**Leakage Test**

Range 1M to 100M ohm (measured at 5V max)
Accuracy ± 5% of measured value (after calibration)

Test Storage

Capacity 2 MB FLASH disk typically storing 16000 records
Actual figure will depend on tests selected and tags stored

Physical Characteristics

Dimensions (Approx.) 270 x 110 x 60 mm (10.63 x 4.33 x 2.36 inches)
Weight (Approx.) 1.5 kg (3.30 lbs.)

Environmental Specifications

Operating temperature range -20 to 60 °C (-4 to 140 °F)
Storage temperature range -40 to 70 ° C (-40 to 158 °F)

NOTE: All capabilities are measured at 20 °C.

1.5 Packaging information

Before getting started please check the package is complete with the following items:

- Transport case
- SMT-200 including carry strap
- Two Battery packs
- Docking Station
- Reference geophone SM4/U-B 10Hz 375 ohm
- Geophone cable Bendix to unterminated incl. temp sensor in Bendix connector
- Cable SMT-200 to Docking Station, Bendix-C24
- Serial cable D9 to D9
- Serial adaptor D9 - D25
- Mains cable (Euro / US / or UK)
- Leakage probe
- Temperature probe
- Spare fuse 500 mA 250V
- Software diskette SMT-200 v2.00 & Docking station programs
- Operations and Technical Manual (this Manual)
- Certificate of calibration

1.6 Before use...

1.6.1 Voltage selection

The docking station requires connection to a suitable power source. **THE SELECTION OF 115 V OR 230 V MUST BE DONE MANUALLY.** Moving a red switch on the rear of the docking station to the appropriate position does this (Docking Station is always shipped with 230 V selected). The docking station is designed to work between 50 Hz to 60 Hz AC so no switching for this is necessary.

Voltage Selector Switch 110 / 230 V

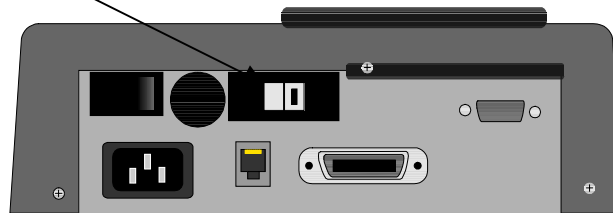

1.6.2 Battery charging

The battery supplied is a maintenance free 1.2 AH Lead Acid Gel Cell. This type of battery can be used in any position and features a low 'self discharge' which means it can be left unused for some time without requiring recharging. Due to the sealed nature of the battery it should only be recharged on the supplied docking station. The battery could be destroyed if it is recharged with the incorrect type of charging unit. To ensure maximum performance from the battery the following guidelines should always be followed:

- Do not leave the battery discharged for extended periods
- Never short circuit the terminals
- If possible avoid charging battery pack at extreme ambient temperatures

Remove battery pack from the SMT-200 and store safely if the SMT-200 is not to be used for an extended period of time



Section 2

SMT-200 Operations

Page intentionally left blank

2.1 SMT-200 Layout

The SMT-200 consists of two parts, the main case and a removable battery pack. The battery pack must be connected for mobile operation. Operation is still possible when connected to the supplied docking station, in which case the battery does not need to be connected. If the battery pack is attached to the main body the docking station will be monitoring the battery and will be automatically charging the battery as required.

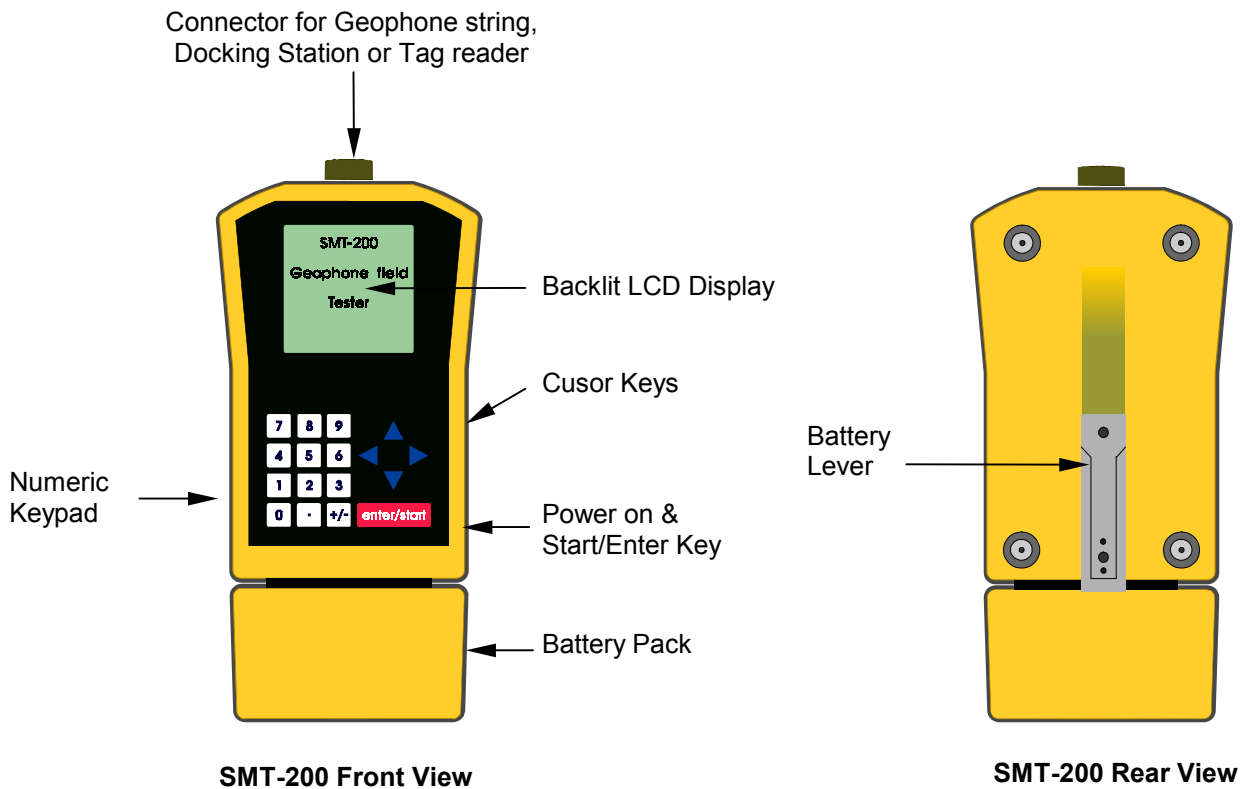

2.2 Switching on the SMT-200

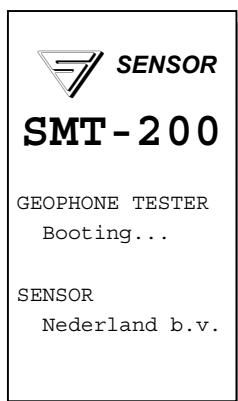

To power up the SMT-200 simply push the **ENTER/START** key once. The unit will beep to acknowledge the power up request. The start up screen will be displayed while the system is going through a set of Power On Self Tests (POST). This is a functional test of the CPU and its associated hardware. After approximately 20 seconds the unit will beep once and the main menu will appear after a further 20 seconds. The unit is now ready for operation. If this is the first time the unit has been used it will need to be setup for the particular strings to be tested. All settings are stored in non-volatile memory and are retained even when the power is off.

2.2.1 Post Mortem on Powering up

```

!!!!!!!!!!!!!!!!!!!!!!

The SMT-200
was not properly
shut down

Shut Down ERROR!
18/11/99 12:35

Press any key
to continue

!!!!!!!!!!!!!!!!!!!!!!
    
```

If the SMT-200 was last shutdown with one of the following errors, a post mortem screen is displayed on the next power up sequence to alert the operator.

- Temperature High** SMT-200 detected an internal temperature greater than 80°C
- Temperature Low** SMT-200 detected an internal temperature lower than -40°C
- Battery Low** SMT-200 detected a battery voltage less than 10.7 V
- Shut Down Error** Abnormal shut down (e.g. battery removed)

2.3 Navigating around the screens

The SMT-200 operates on a simple menu system. There are two ways to access the sub-menus:

```

Main menu
-----
1>Do a test...
2 Setup menu...
3 Temp. menu...
4 File menu...
5 Tag menu...
6 About...

0 Shut down
-----
Enter test mode
    
```

CURSOR CONTROL Use the cursor keys to move to the required sub-menu. Once the cursor is next to the selected menu hit the **ENTER/START** key to select the sub-menu. The down and right cursors move down the screen and the up and left cursors move up the screen.

DIRECT CONTROL Hit the number corresponding to the desired sub-menu on the numeric keypad. This will take you directly to the required menu.

NOTE: The Tag Reader **5** is an SMT-200 optional extra. If not used all menu items related to this feature can be removed from SMT-200 menu item display via the Docking Station Option screen.

For example **Redisplay last** is item 1 on the **File menu**. This particular option will display the last test record that was recorded. From the **Main menu** press **4** to take you to the **File menu**. Press **1** to directly enter the **Redisplay last** option. Press **0** to return to the **File menu** and **0** again to return you to the **Main menu**. With a little practice this gives you a fast and powerful way of accessing the menu items.

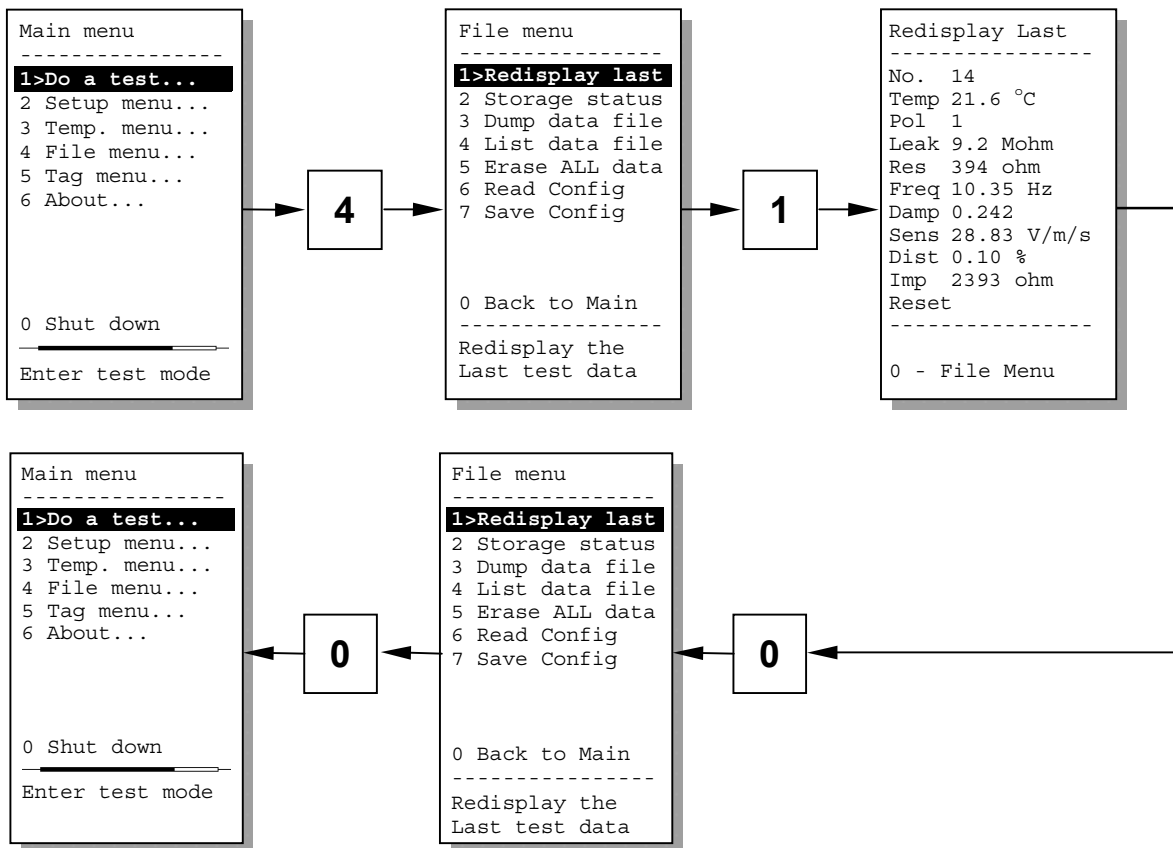

Some menu items require a numeric input while others simply toggle between two values. To enter new numerical values first press **ENTER/START** to enter the edit mode. Next enter the required value. If you make a mistake you can use the left cursor to move back. Once you have entered the edit mode you can also use the up and down cursor keys to increment or decrement the value. Once the value is correct hit **ENTER/START** to accept this value. On items that have two states e.g. ON or OFF move the cursor to the desired option and use the **ENTER/START** to change the option state. Alternatively the numeric keypad can be used to change the state.

For example to turn the LCD backlight on or off select **2>Setup menu** then **6>Display menu** then, depending on it's state hitting **1** will turn the backlight on or off. The backlight can now be turned on or off by repeatedly hitting the **1** key. Hit **0** then **0** to return to the **Main menu**.

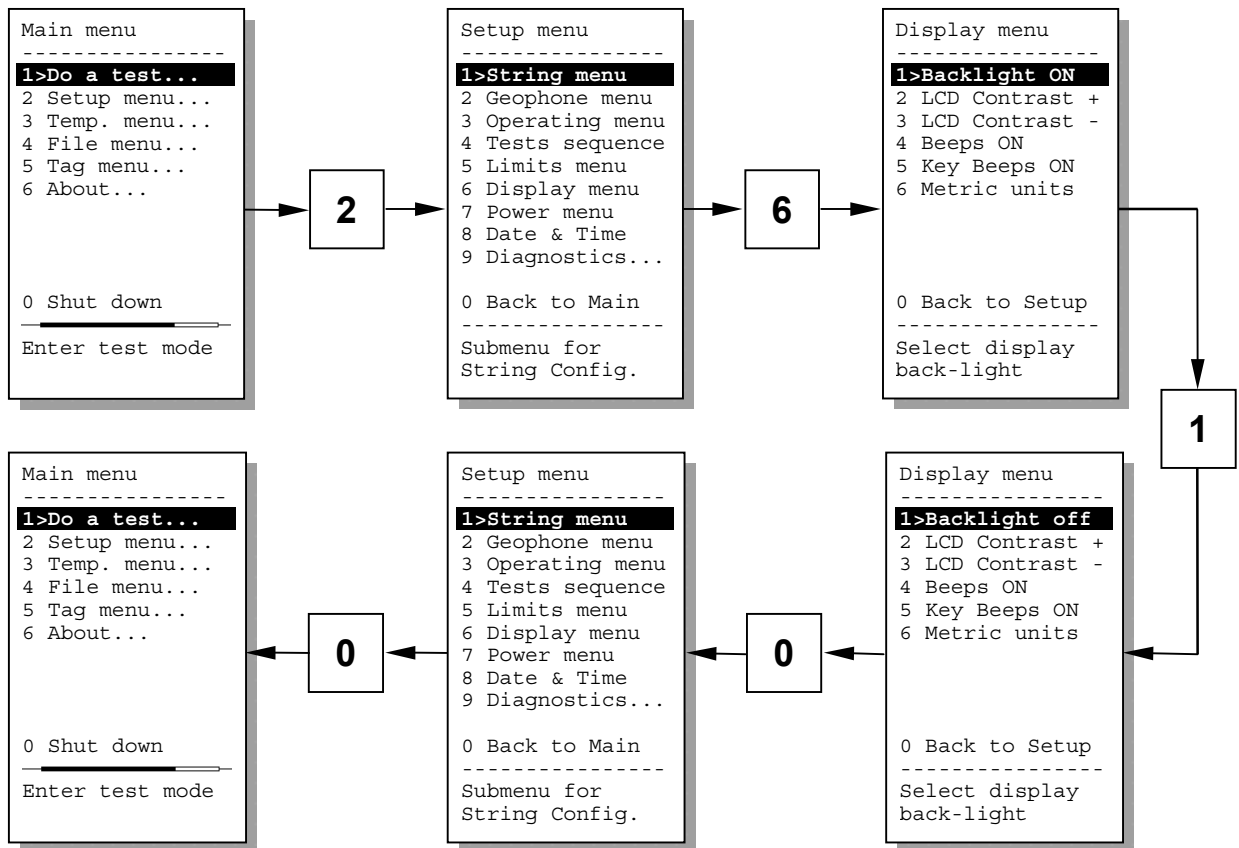

The shorthand notation for these actions that is used throughout the manual is [2-6-1] which signifies the keystrokes needed

2.4 Switching off the SMT-200

To shut the SMT-200 down return to the main menu then select **0**. This will begin the shut down sequence. Firstly the SMT-200 configuration file is saved. Then Log Off delay count begins (set in menu item [2-7-5]). During this time period the shut down sequence can be aborted by hitting the **0** key. Once the count down timer expires the SMT-200 will be safely shut down.

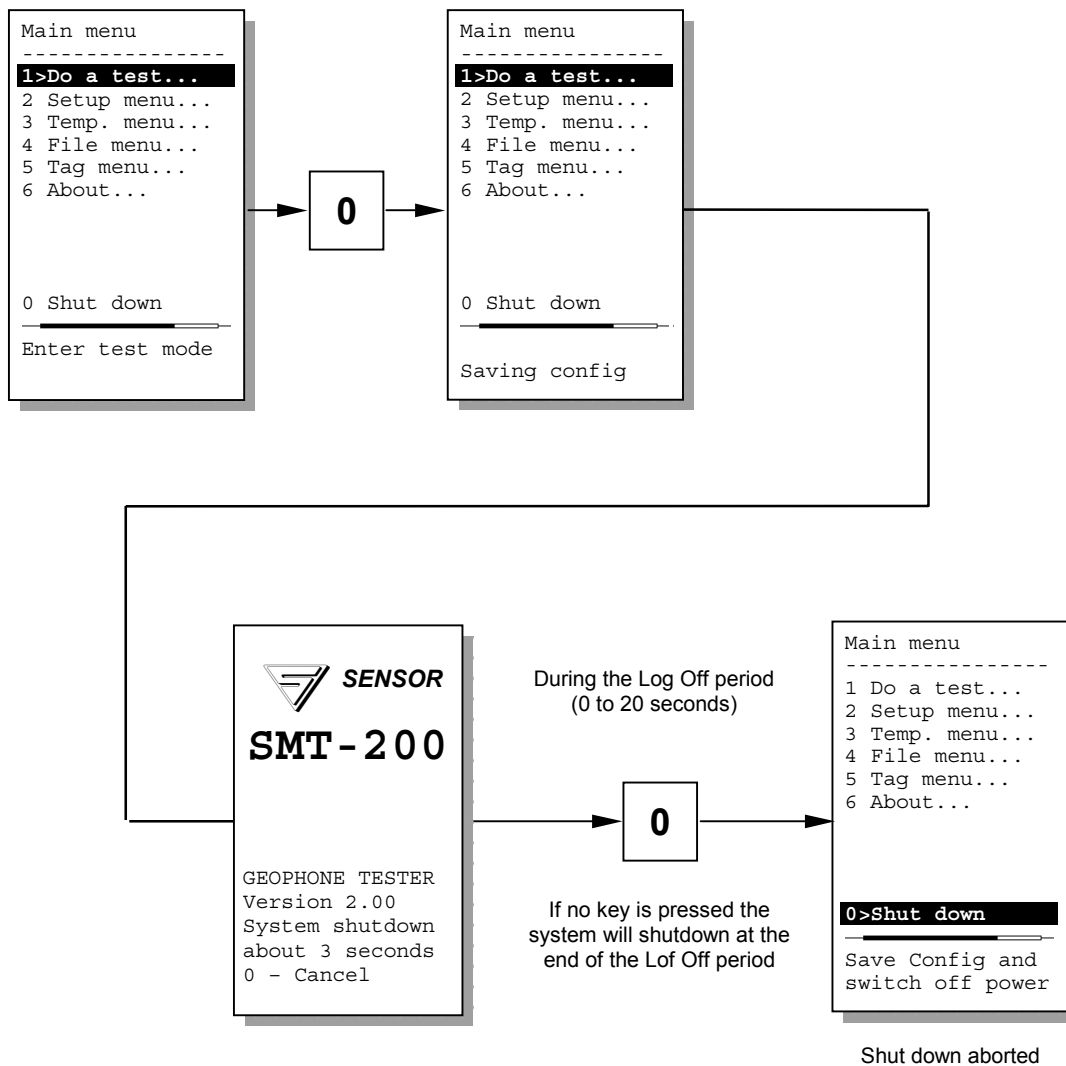

The SMT-200 will shut down automatically if left unattended for a time period set in [2-7-4] or if the battery voltage drops below 10.7 volts.

NOTE: In the rare case that the SMT-200 locks up and cannot be shut down at all then the only way to reset the tester is to remove the battery pack. **USE ONLY AS A LAST RESORT.**

2.5 Battery level

Battery charge condition is monitored and displayed as a bar graph indicator, which is visible in the **Main menu**, **Do a test** and **Diagnostics** Battery test screens. It provides the user with a guide of the remaining operational time of the SMT-200 with the attached battery pack.

Bar Graph Indicator of battery status:

Battery almost full



Battery half-full



Battery almost empty



Screens where the Battery Status Monitor is Displayed:

```

Main menu
-----
1>Do a test...
2 Setup menu...
3 Temp. menu...
4 File menu...
5 Tag menu...
6 About...

0 Shut down
-----
Enter test mode
    
```

```

String Config.
-----
[Sensor-SM4]
Temp [20.0 °C]
Series [1]
Parallel [1]
Not shunted
Next# [1 A]

Estimated space:
3276 Records

-----
0 Back to Main
- Repeat Test
Start next Test
    
```

```

--Test results--
No. 1
Temp 20.0 °C
Pol 1
Leak 1401 Mohm
Res 382 ohm
Freq 9.91 Hz
Damp 0.259
Sens 28.7 V/m/s
Dist 0.04 %
Imp 2205 ohm
Test OK

-----
0 Back to Main
- Repeat Test
Start next Test
    
```

2.6 Battery level Jumper setting

Function of the battery level monitoring requires that jumper **JP5** located on the SMT-200 main PCB be set to the **BatTst** position. When upgrading software on older SMT-200's it's possible that this jumper may need to be repositioned.

NOTE: This option is not available on early SMT-200 models of revision 1 and lower.

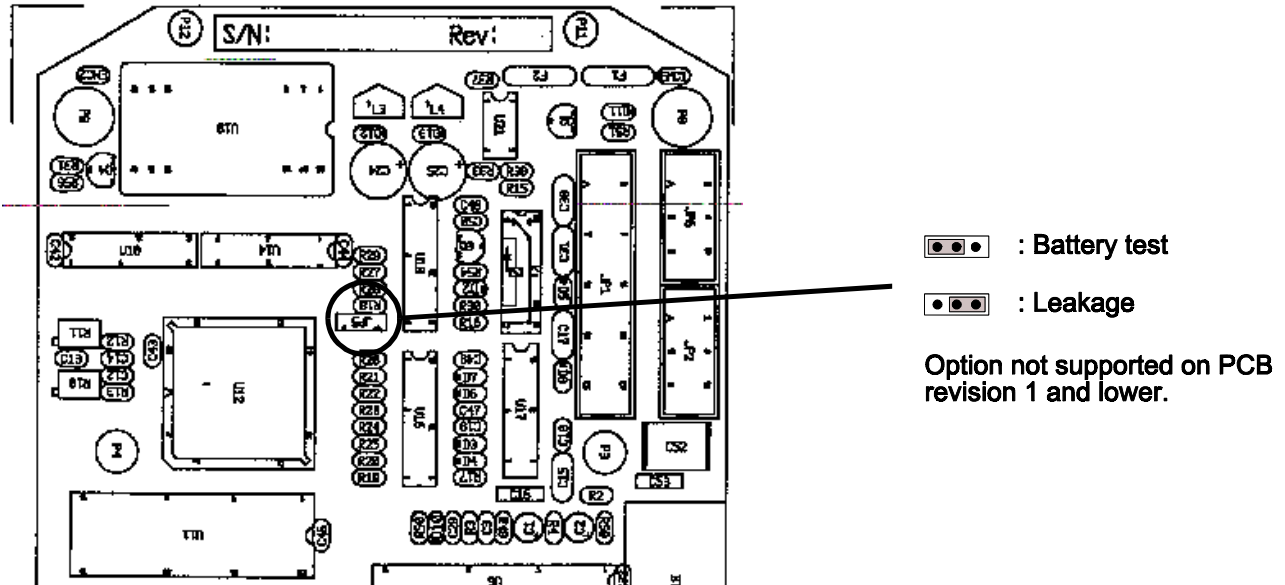

2.7 Menu flowchart

The flowchart shows the menu system of the SMT-200.

Software Version 2.00

```

Main menu
-----
1>Do a test...
2 Setup menu...
3 Temp. menu...
4 File menu...
5 Tag menu...
6 About...

0 Shut down
-----
Enter test mode
    
```

Main Menu Structure

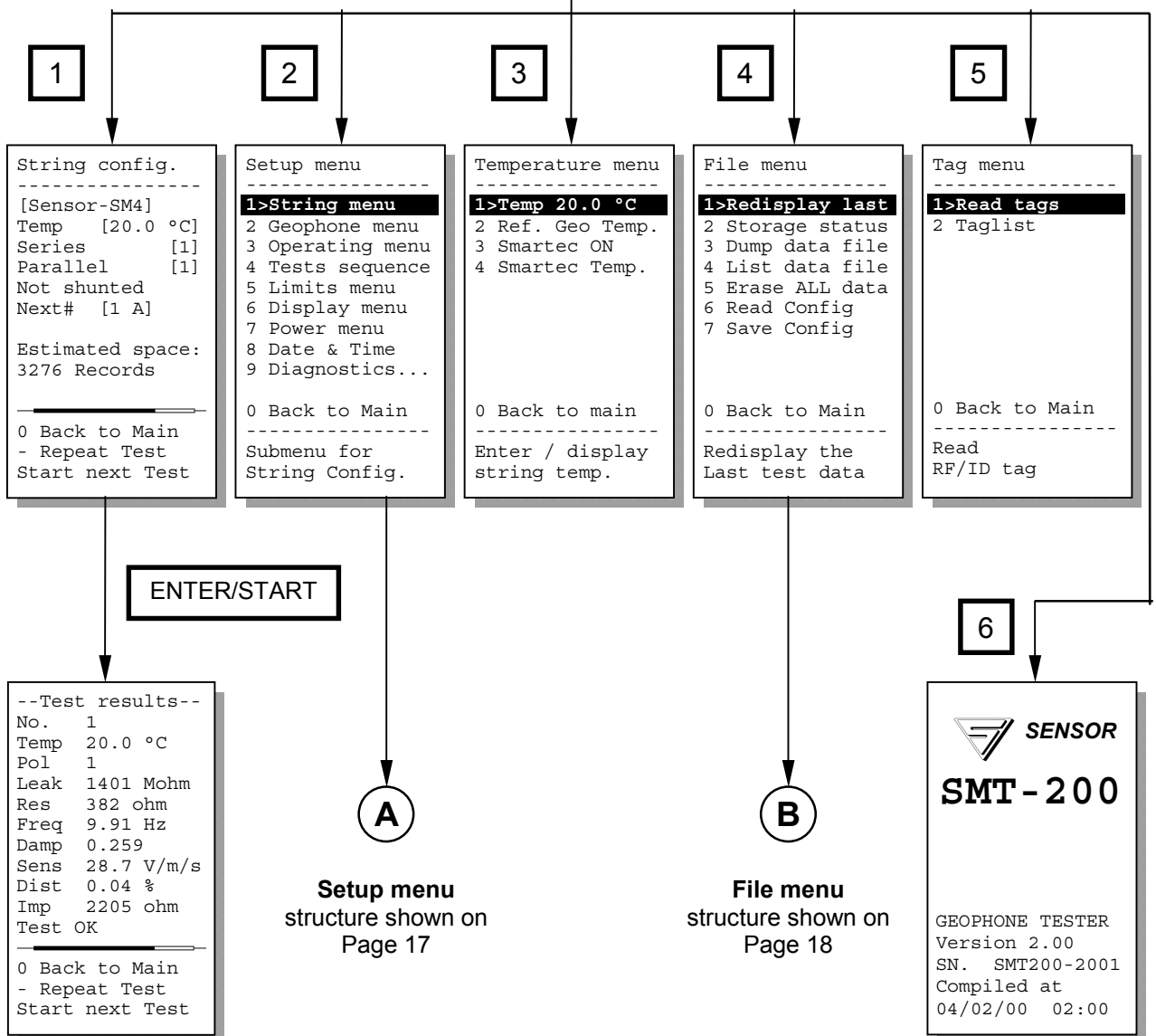



Setup Menu Structure

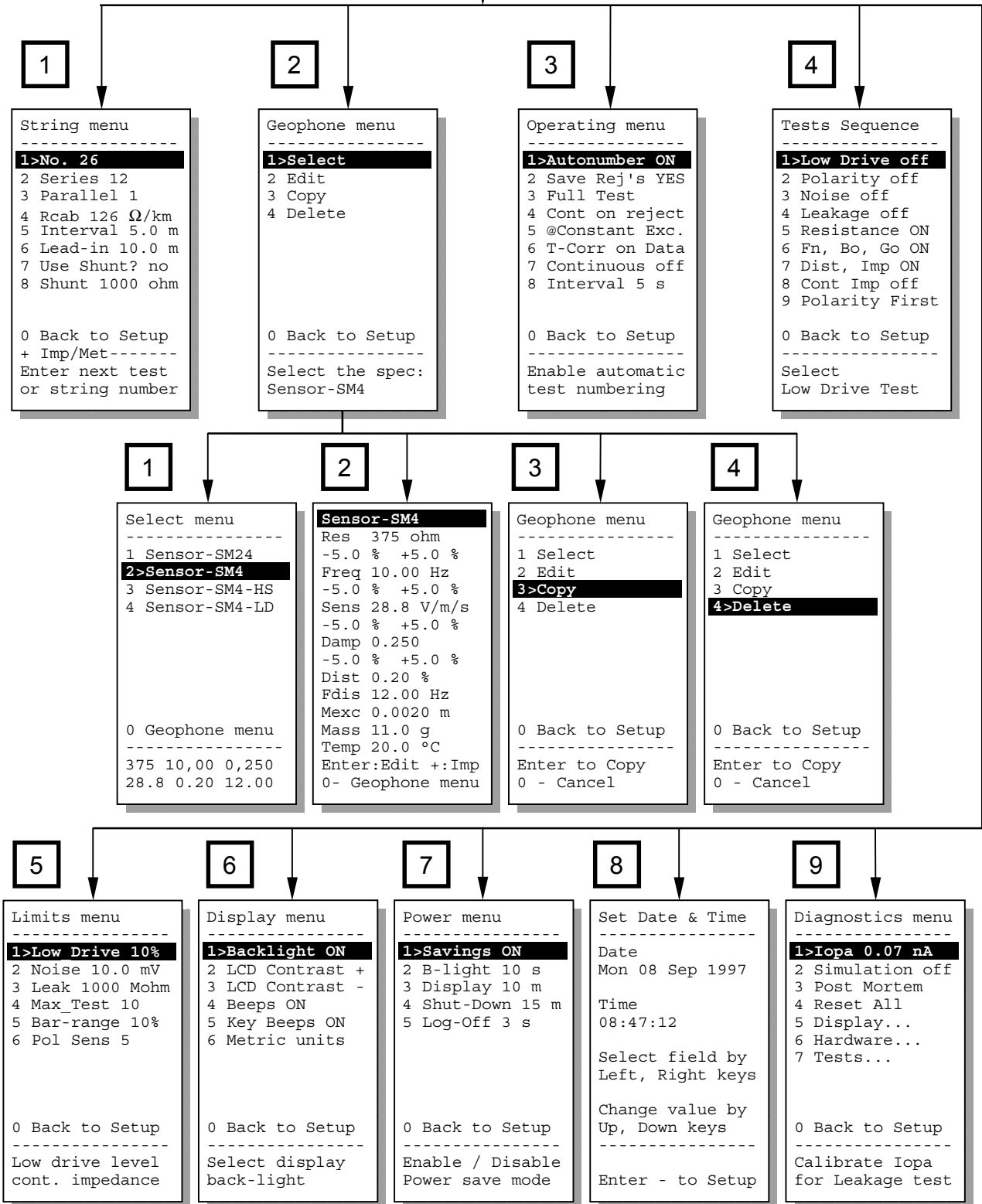

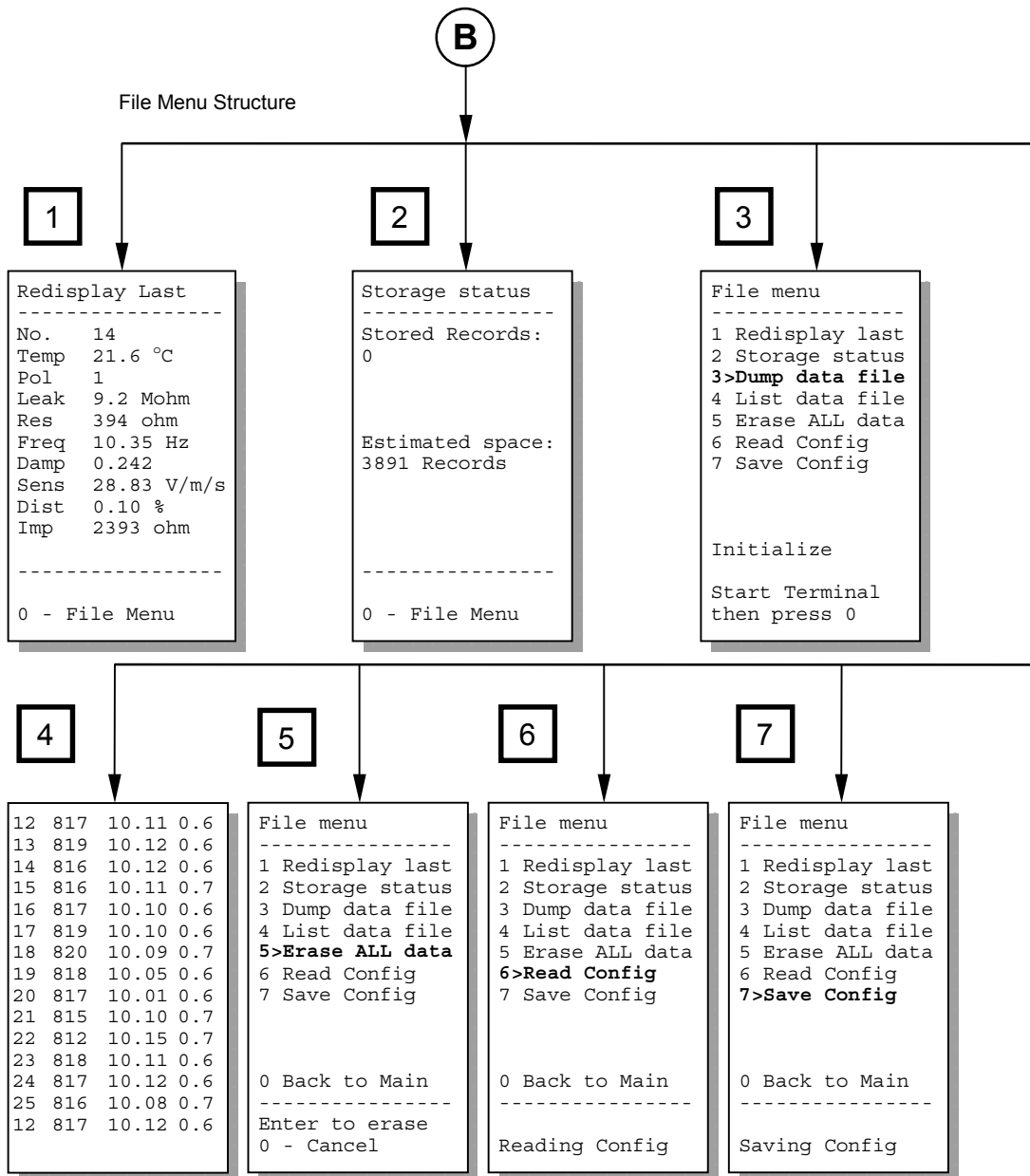

In the following description the **bold** item represents the section and the remaining digits represent the keystrokes required to access the selection.

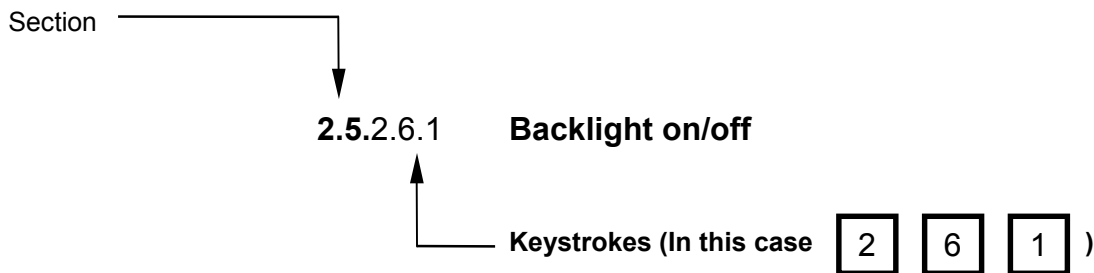

2.8 Main menu

```

Main menu
-----
1>Do a test...
2 Setup menu...
3 Temp. menu...
4 File menu...
5 Tag menu...
6 About...

0 Shut down
-----
Enter test mode
    
```

The main menu allows access to all functions of the SMT-200

Do a test...	Acquire test record.
Setup menu...	Enables you to set the parameters of the string under test, tests to be performed and miscellaneous SMT-200 settings.
Temp. menu...	Sets temperature adjustment parameters.
File menu...	Allows manipulation of stored record and configuration files and data downloads.
Tag menu...	Used in conjunction with the Tag reader (see Appendix D) manages automated tag and geophone string identification.
About...	Gives version number, serial number and software release date.
Shut Down	Saves current configuration and turns the unit off. Hit 0 to abort the shut down process once initiated.

2.9.1 Do a test

Select this option to initiate a test sequence on a string

```

1>Do a test...
-----
String config.
-----
[Sensor-SM4]
Temp [20.0 °C]
Series [1]
Parallel [1]
Not shunted
Next# [1 A]

Estimated space:
3276 Records

0 Back to Main
- Repeat Test
Start next Test
-----
--Test results--
No. 1
Temp 20.0 °C
Pol 1
Leak 98 Mohm
Res 382 ohm
Freq 9.91 Hz
Damp *0.270
Sens 28.7 V/m/s
Dist 0.04 %
Imp 2205 ohm
Damping High

0 Back to Main
- Repeat Test
Start next Test
    
```

[Sensor-SM4]	Current geophone element selected.
Temp [20.9 °C]	String temperature to be used in test.
Series [1]	Geophone elements in series.
Parallel [1]	Branches in parallel.
Not Shunted	Identifies if a shunt resistor is used.
Next# [15 A]	The string number of the next string to be tested.
Estimated Space	Gives an approximation to the amount of records that can be stored with the available memory left.
Back to Main	Return to the Main menu .
Repeat Test	Repeat test, overwriting previous string results.
Start next test	Start test data collection for current string.

No.	Record number of the stored result.
Temp	Temperature set when tests were recorded.
Pol	1 = SEG, -1 = Non SEG, 0 = Polarity not tested.
Leak	String DC leakage in MΩ.
Res	DC resistance of geophone string in Ω.
Freq	Natural frequency of geophone string in Hz.
Damp	Damping of geophone string.
Sens	Sensitivity of geophone string in V/m/s.
Dist	Distortion of geophone string in %.
Imp	AC impedance of geophone string in Ω.

Back to Main / Repeat Test / Start See above

* Next to any reading indicates parameter is out of spec.
 Displayed items vary with the test selected.

2.10.2 Setup menu *Allows customisation of the SMT-200 operating and test parameters*

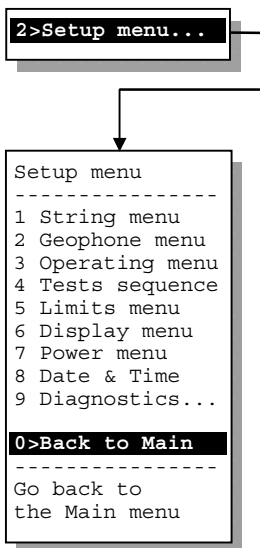

- String menu** Setup string configuration & shunt resistor options.
- Geophone menu** Select or edit geophone element used in strings.
- Operating menu** Miscellaneous test parameter selection.
- Test Sequence** Tests to be performed selection.
- Limits menu** Sets: Low_Drive, Noise, Leakage, Max_Test, Bar_Range, Pol_Sens reject or levels.
- Display menu** LCD and sounder configuration. Metric/Imperial unit select.
- Power menu** Power saving options.
- Date & Time** Date and time setting facility.
- Diagnostics...** SMT-200 calibration check and diagnostics.
- Back to Main** Return back to the **Main menu**.

2.11.2.1 String menu *Set the string geometry and leader parameters*

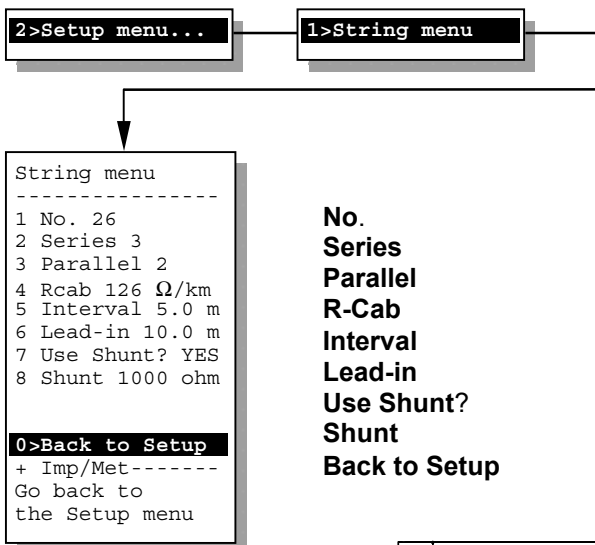

- No.** Identification number of geophone string.
- Series** Number of elements in series.
- Parallel** Number of elements in parallel.
- R-Cab** Leader cable resistance in Ω/km.
- Interval** Distance between geophones in m.
- Lead-in** Distance of lead-in cable in m.
- Use Shunt?** Option to include damping resistor in calculations.
- Shunt** Value for damping resistor if used in Ω.
- Back to Setup** Return back to the **Setup menu**.

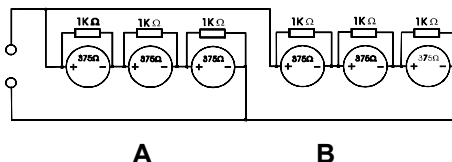

Series elements = 3
Parallel elements = 2

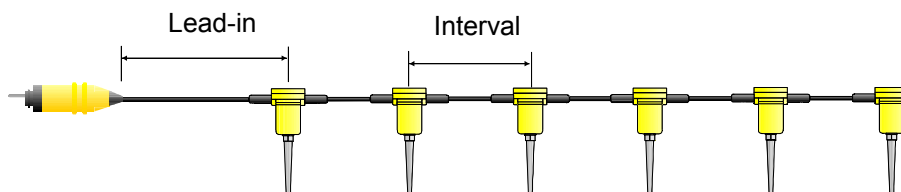

Example of a geophone string configuration



The string on the previous page represents the string shown in the **String menu**. The above diagram shows 6 geophone elements wired as group A and group B. Both group A and B consist of 3 elements in series. There are 2 parallel groups A and B. This information allows the SMT-200 to determine the strings geometry. The string shown here incorporates damping resistors so the shunt option [2-1-7] should be set to YES and the value [2-1-8] set to 1000. The geophone elements properties are known by the information set in the **Geophone menu** [2-2]. The cable length can be calculated by multiplying the total number of elements less one by the distance between elements and adding the lead-in cable distance. This can be converted to a resistance by using the cable resistance that has been set in [2-1-4]. Once this information has been temperature compensated [3-1] the SMT-200 has all the information it needs to know about the string.

2.12.2.1.9 Limits menu *Sets maximum allowable limits for various tests*

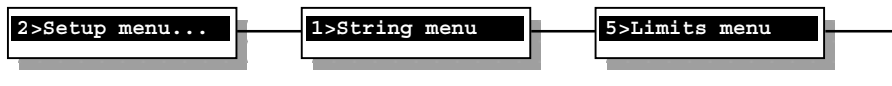

```

Limits menu
-----
1>Low Drive 10%
2 Noise 10.0 mV
3 Leak 1000 Mohm
4 Max_Test 10
5 Bar-range 10%
6 Pol_Sens 5

0 Back to Setup
-----
Low drive level
cont. impedance
  
```

- Low_Drive** Specifies drive level for the Low drive continuous impedance test in percent. Input range is 1-99% (default is 10% of nominal drive level).
- Noise** Maximum limit allowable for ambient noise in mV.
- Leak** Minimum allowable leakage in MΩ.
- Max_Test** Maximum number of tests when Continuous mode selected.
- Bar_range** Specifies bar graph sensitivity for continuous impedance test . Input range is 1-99% (default is 10%).
- Pol_Sens** Specifies tap sensitivity for the Polarity test. Input range is from 1-10 (default is 5).

2.13.2.2 Geophone menu *Selects and modifies if required the type of geophone element used*

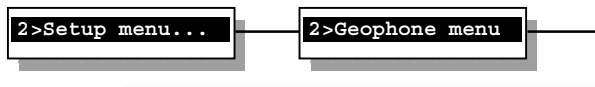

```

Geophone menu
-----
1>Select
2 Edit
3 Copy
4 Delete

0 Back to Setup
-----
Select the spec:
Sensor-SM4
  
```

- Select** This is used to change the basic element type used in the string.
- Edit** Any of the basic geophone parameters can be modified if required. It is not recommended to alter the supplied specification for the Sensor strings.
- Copy** Copy the selected element type to a new element type. The original element description is unchanged.
- Delete** Removes the selected element description from memory. Once deleted it cannot be recovered.

2.14.2.2.1 Select menu *Selects the type of geophone element used*

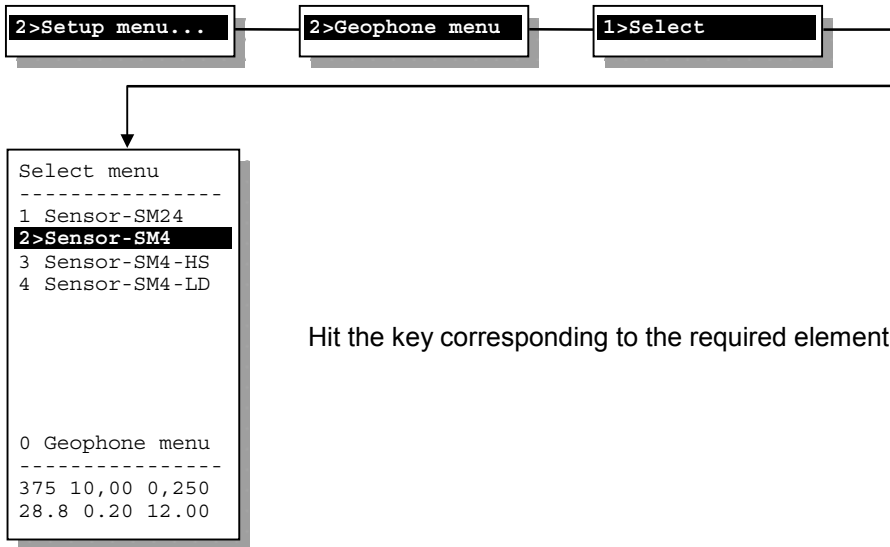

Hit the key corresponding to the required element.

2.15.2.2.2 Edit *Edit the geophone parameters*

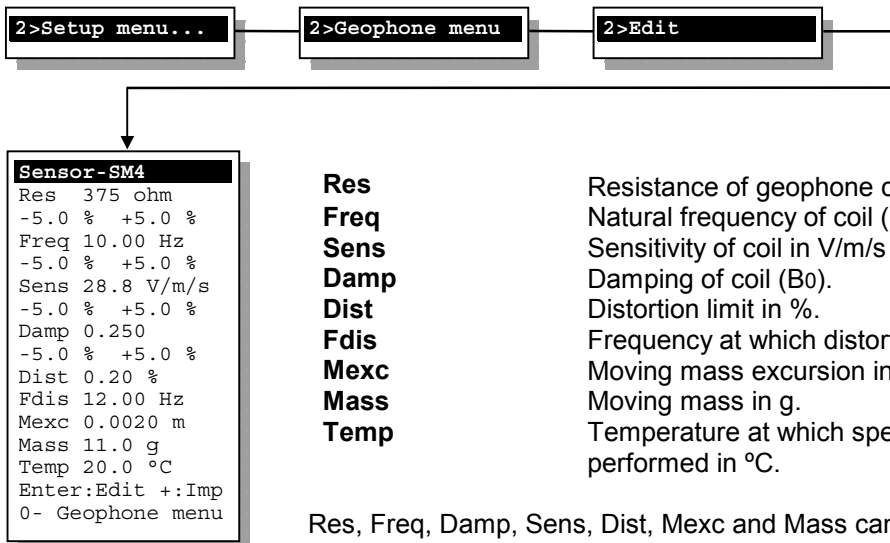

- Res** Resistance of geophone coil in Ω (R_c).
- Freq** Natural frequency of coil (F_n or sometimes F_0) in Hz.
- Sens** Sensitivity of coil in V/m/s (G).
- Damp** Damping of coil (B_0).
- Dist** Distortion limit in %.
- Fdis** Frequency at which distortion will be tested in Hz.
- Mexc** Moving mass excursion in m.
- Mass** Moving mass in g.
- Temp** Temperature at which specs are valid will be performed in $^{\circ}\text{C}$.

Res, Freq, Damp, Sens, Dist, Mexc and Mass can be found on the manufacturers data sheet for the particular element in use.

TIP: use the +/- key to switch between metric and imperial units if necessary

2.16.2.2.3 Copy *Copy existing element description to a new geophone type*

Hit **ENTER/START**, a new description will be generated with the filename ***newspec#** where # is the allocated sequential file number. This will then be the selected geophone.

2.16.2.2.4 Delete *Deletes an existing element description*

Hit **ENTER/START**, the currently selected element description will be deleted.

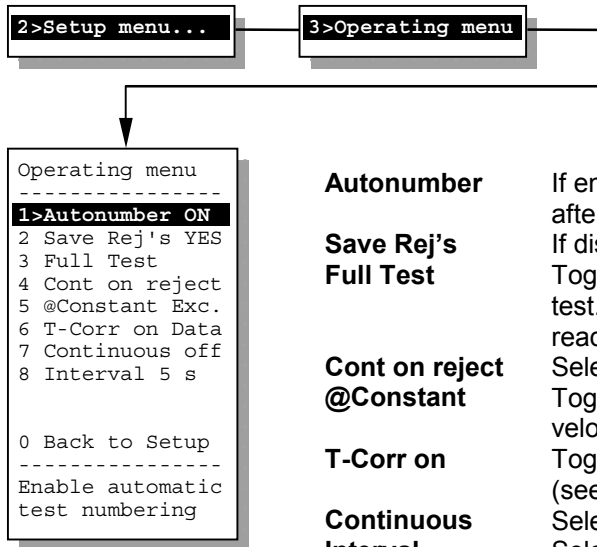
2.17.2.3 Operating menu *General options for string testing*

Autonumber	If enabled the string ID number will increment by one after every accepted test.
Save Rej's Full Test	If disabled only successful tests will be recorded. Toggle between display Full Test Results or Go/No-Go test. The Go/No-Go test will not record detailed readings, just a pass or fail result.
Cont on reject @Constant	Selects abort or continue test on the first reject found . Toggles between constant excursion and constant velocity. See explanation below.
T-Corr on	Toggles temperature correction between data and spec. (see below)
Continuous Interval	Selects continuous testing mode. Selects interval between tests in continuous mode.

When testing geophones with natural frequencies below 12Hz the selection of constant velocity or constant excursion for the distortion test becomes significant. For geophones above 12Hz, constant excursion and constant velocity are equivalent.

Constant velocity	The distortion test drives the moving mass inside the element at a particular drive level and checks for harmonics that the element itself introduces. In the case of a constant velocity drive the drive level is fixed at 0.7 in/s (0.01778 m/s). The actual excursion that this produces will depend on the frequency of the drive signal and the natural frequency of the element. Lower drive frequencies will result in a proportional increase in the moving mass excursion. The increased movement could result in increased distortion due to the springs being driven into a non linear region. To take this into account the test can be carried out with a constant excursion.
Constant excursion	With this test the drive current (and so the drive level) is compensated to allow for testing at frequencies other than 12 Hz. By altering the drive level the excursion of the moving mass can be kept to 0.236 mm, which is the same value as would have been produced driving the moving mass at 12 Hz with a 0.7 in/s drive. This should give consistent results regardless of the test frequency. The frequency at which the distortion is tested is selected in the geophone menu. <i>Recommended setting.</i>
T-Corr on	Temperature compensation can be applied to either the geophone specifications or the captured data. In the first case there is no temperature adjustment performed on the data but the original specs. Alternatively the uncompensated specs can be used in which case the data will be temperature compensated. See section 2.5.3.

2.18.2.4 Tests Sequence *Selects the tests to be performed on the string*

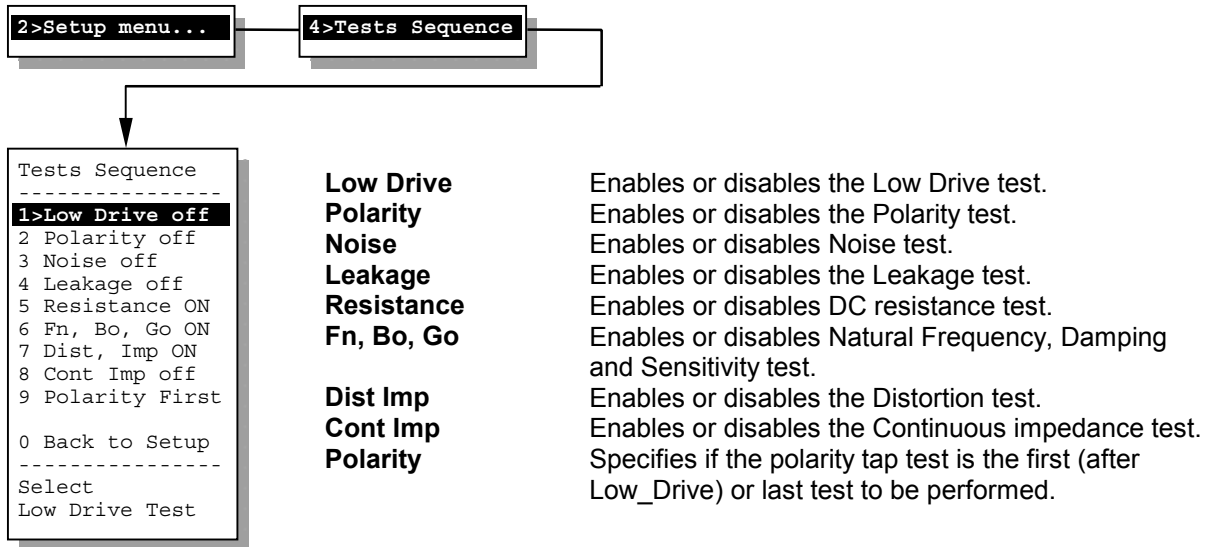

2.19.2.5 Display menu *Customises display, keypad and sound options*

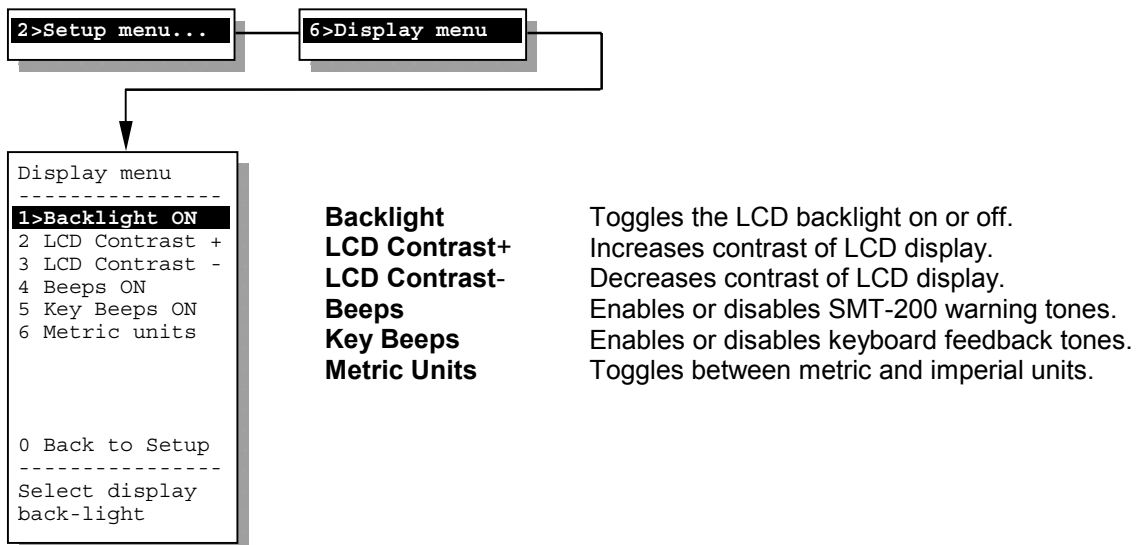

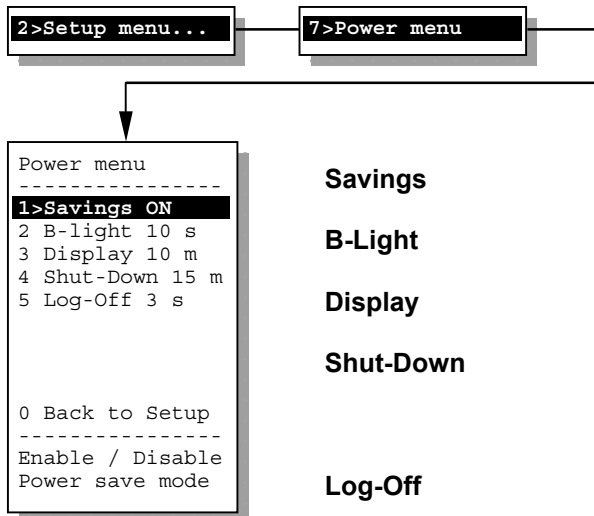
2.20.2.7 Power menu
Selects the various power saving options

Savings

Enables or disables all of the power saving features.

B-Light

Sets the time the backlight switches on for after a key has been pressed in seconds.

Display

Sets the time the display remains on for after the last key press in minutes.

Shut-Down

Sets the time the SMT-200 remains on for before beginning an auto shutdown sequence in minutes. This time is reset with each key press. No data is lost if the unit does shutdown automatically.

Log-Off

Sets the time the SMT-200 takes to shutdown in seconds.

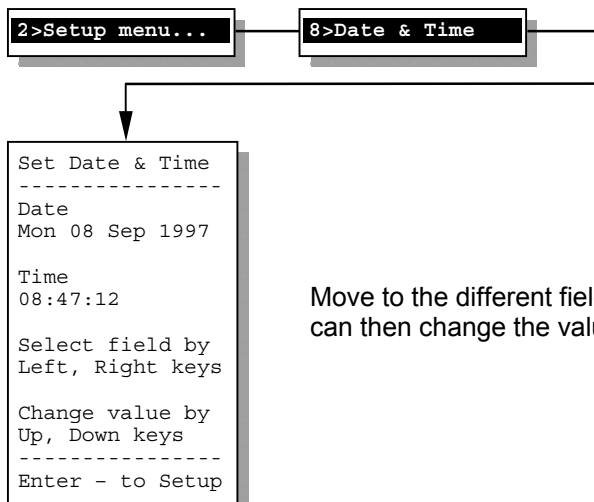
2.21.2.8 Date & Time
Sets the SMT-200 clock

Move to the different fields by pressing the left and right cursor keys. You can then change the value by the up and down cursor keys.

2.22.2.9 Diagnostics

Runs the diagnostics and calibration routines

NOTE: Use the Diagnostics test plug (part number SMT-200 C 0515) where indicated. When exiting Diagnostics Test routine all settings are restored to original values.



```

Diagnostics menu
-----
1>Iopa 0.07 nA
2 Simulation off
3 Post Mortem
4 Reset All
5 Display...
6 Hardware...
7 Tests...

0 Back to Setup
-----
Calibrate Iopa
for Leakage test
  
```

To access this menu after selecting **Diagnostics** it you are required to enter a **PIN** (Personal Identification Number) to access the menu. The **PIN** is the serial number of the SMT-200 that can be found from the about menu.

Iopa Is for calibration of the leakage test. To use this connect the SMT-200 Diagnostics test plug or place the required resistance (100MΩ default) between the leak and geophone negative terminal. After calibration the measured value should be about the same as the expected leakage of the strings (or 100MΩ whichever is lower). On selection of this test you are requested to enter the value for the test resistor. Once this has been done the SMT-200 will calculate the leakage current and thus be able to accurately calculate leakage values.

Simulation This will allow you to generate synthetic data instead of real collected geophone data. This is particularly useful for training and getting used to the SMT-200 without needing to have a strings connected. Make sure this is set to “off” before testing actual strings. Test results are saved with the comment SIMULATION.

Post Mortem Shows how the unit shut down previously. The table below shows the various messages and the meaning of each.

Reset all Restores all SMT-200 settings to their default values and load the SM-4 10Hz 375Ω geophone specification. Restored values are also saved to the configuration file. (To reset display contrast press the +/- key during booting).

Post Mortem messages	
Normal Shut Down	Regular shut down with no problems detected
Temperature High	SMT-200 detected an internal temperature greater than 80°C
Temperature Low	SMT-200 detected an internal temperature lower than -40°C
Battery Low	SMT-200 detected a battery voltage less than 10.7 V
Timed Out	Shut down initiated by power saving function (set in Power menu)
Shut Down Error	Abnormal shut down (e.g. battery removed)

Display

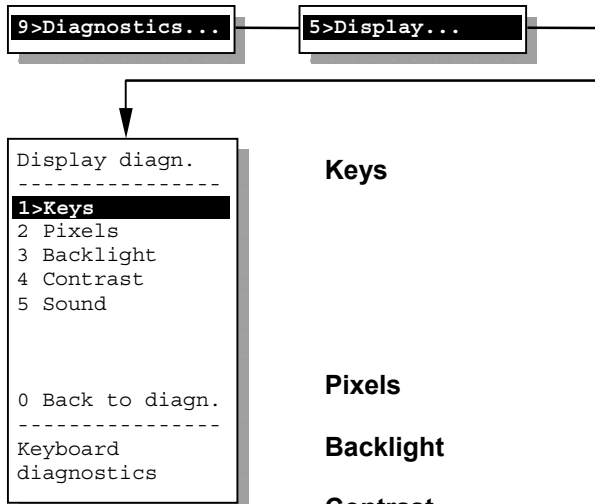

Keys

Checks that all keys are functioning correctly. When a key is pressed the corresponding block displayed on the screen is shown in reverse video. Pressing the same key again will remove the reverse video block. Test all keypad keys in this manner. To quit this test, press the **0** and **ENTER/START** key at the same time.

Pixels

All display screen pixels are blacked to check operation. Exit test by pressing any key.

Backlight

Display backlight is turned on and off at half second intervals. Exit test by pressing any key.

Contrast

Contrast steps through each contrast step (0..15) and displays the current setting. Exit test by pressing any key.

Sound

Loudspeaker is driven with a frequency scaling continually from 100 to 6000 Hz and with the Frequency displayed. Exit test by pressing any key.

Hardware

Use the Diagnostics test plug for each of these tests.

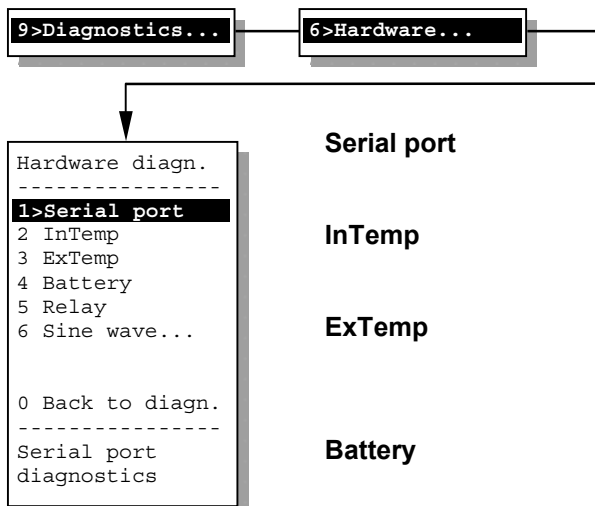

Serial port

Rx and Tx lines are linked together and a communications test run. If successful **Ok** is displayed and with a failed test **Nok**.

InTemp

SMT-200 internal temperature is continually measured and displayed. Exit test by pressing any key.

ExTemp

SMT-200 external temperature probe is continually measured and displayed. If no probe is connected message **n/a** is displayed. Exit test by pressing any key.

Battery

Battery voltage is monitored and displayed together with the Low bat. Shutdown status. **Ok** is displayed if the battery voltage is higher than 10.7 volts and Low if below. Press any key to exit test.

Relay

Internal reference resistor (499Ω 0.01%) and a reference resistor connected to the geophone input are measured and their values displayed.

Sine wave

Enter this sub menu to perform sine wave tests.

Sine wave

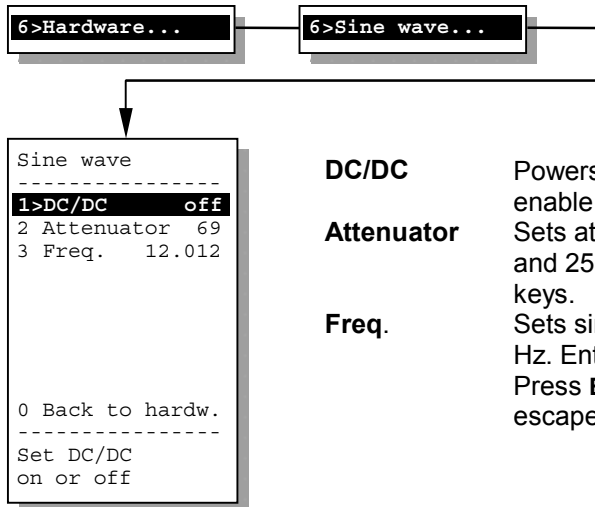

- DC/DC** Powers the SMT-200 analogue circuit up or down to enable analogue circuit test measurement.
- Attenuator** Sets attenuator range setting, value must be between 0 and 255. Enter value via keypad or using the arrow up/dn keys.
- Freq.** Sets sine wave frequency between 0.018 and 291.304 Hz. Enter value via keypad or using the arrow up/dn keys. Press **ENTER/START** to accept value or right arrow key to escape.

Tests

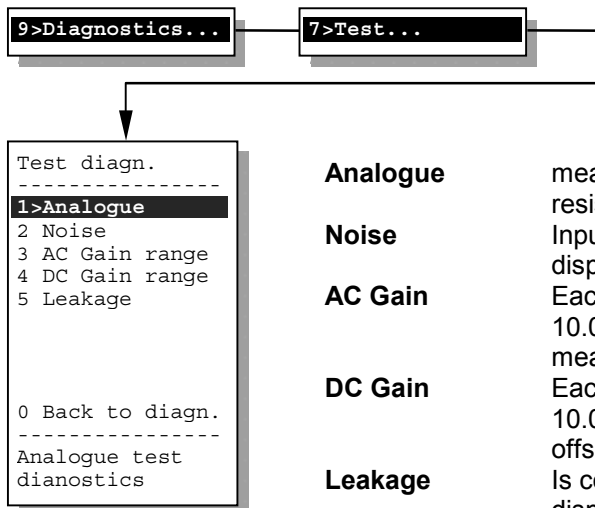

- Analogue** measures and records: Internal temperature, Offset, DC resistance, Distortion and Dynamic resistance.
- Noise** Input terminal noise is continuously measured and displayed. Exit test by pressing **0**.
- AC Gain** Each range (0.08, 0.16, 0.31, 0.63, 1.25, 2.50, 5.00, 10.00) is tested using a sine wave voltage and the measured offset and AD reading is reported.
- DC Gain** Each range (0.08, 0.16, 0.31, 0.63, 1.25, 2.50, 5.00, 10.00) is tested using a DC voltage and the measured offset and AD reading is reported.
- Leakage** Is continuously measured and the resultant value displayed. Exit test by pressing **0**.

2.23.3 Temp. menu *Read or set the external temperature and temperature options*

It is important to compensate the SMT-200 results to allow for temperature variations. The materials used within the string itself have a temperature coefficient, which means the geophone properties will change with temperature. The operating menu allows you to make the compensation on the data or specs. The temperature menu allows you to set the temperature used in the calculation.

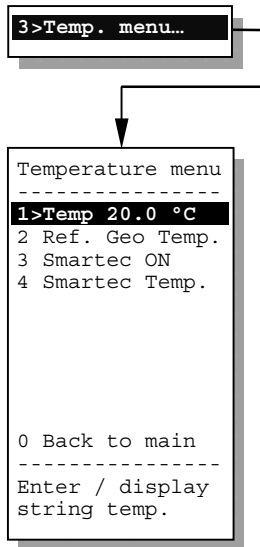

- Temp** Manually enter the string temperature in °C.
- Ref. Geo Temp.** Read and store the temperature using the supplied reference geophone.
- Smartec** Turns the Smartec on or off.
- Smartec Temp.** Read and store the temperature using the external Smartec.

NOTE: When manually entering the temperature make sure that use of the temperature sensor is disabled (Temperature command 3). All following measurements will be corrected with the entered value.

The SMT-200 automatically corrects the display contrast setting according to temperature measured and indicated in system temperature.

Temperature command 2 allows you to measure the temperature with the use of the supplied reference geophone. The SMT-200 measures the coil resistance of the reference geophone. Assuming any deviation from the nominal value at 20°C is due to temperature variation the actual temperature can be calculated.

There is a Smartec temperature sensor built into the Bendix connector of the SMT-200. It is important to make sure that the temperature of this connector is the same as the temperature of the geophones under test. See Smartec connections in appendix A for further details.

The cable which connects the SMT-200 with the Docking Station does not have a built-in Smartec sensor. The 1 m cable supplied with a Smartec sensor and RJ-11 connector at the other end provides the SMT-200 with an identical temperature measurement option when it is connected to the Docking Station.

When Smartec temperature measurement is enabled, choosing Temperature command 4 will refresh the displayed temperature. In normal use the SMT-200 will automatically measure and update the temperature every minute. If a test is being run at that time the update is due then the temperature will be updated at the end of the test.

2.24.4 File menu

Internal file handling and data / code transfer options

```

4>File menu...
-----
File menu
-----
1>Redisplay last
2 Storage status
3 Dump data file
4 List data file
5 Erase ALL data
6 Read Config
7 Save Config

0 Back to Main
-----
Redisplay the
Last test data
    
```

Redisplay Last Storage status

Displays the results of the last test run. Internal memory status and post mortem shutdown status.

Dump data file

Send the data file to an external serial device (e.g. serial printer or PC running in a terminal emulation mode).

List data file

List data file held in internal memory.

Erase data

Delete all records held in memory.

Read Config

Reloads SMT-200 configuration file from memory.

Save Config

Saves SMT-200 configuration file to memory.

2.25.4.1 Redisplay Last

Shows the result of the last test run

```

4>File menu...
-----
1>Redisplay last
-----
ay Last
-----
No.    14
Temp  21.6 °C
Pol    1
Leak   9.2 Mohm
Res    394 ohm
Freq   10.35 Hz
Damp   0.242
Sens   28.83 V/m/s
Dist   0.10 %
Imp    2393 ohm
Test   OK
-----
e Menu
    
```

If a test has not been run since the SMT-200 was switched on there will be no meaningful data shown.

2.26.4.2 Storage Status *Indicates the internal memory storage*

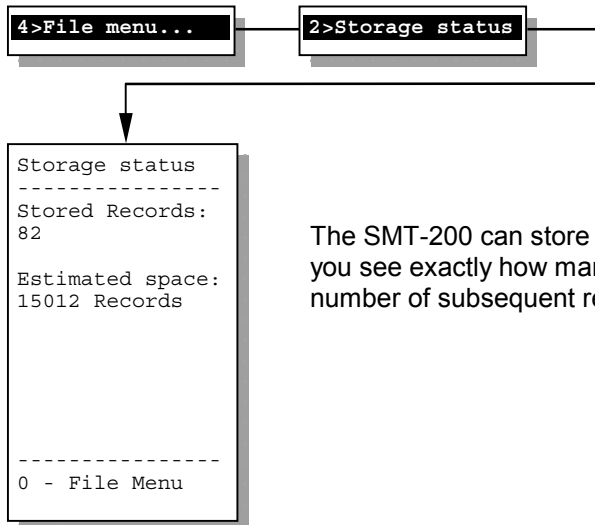

The SMT-200 can store around 16000 records. The *Storage status* will let you see exactly how many records are held in memory and the estimated number of subsequent records that can be stored.

2.27.4.3 Dump data file *Transfer contents of data file to COM port*

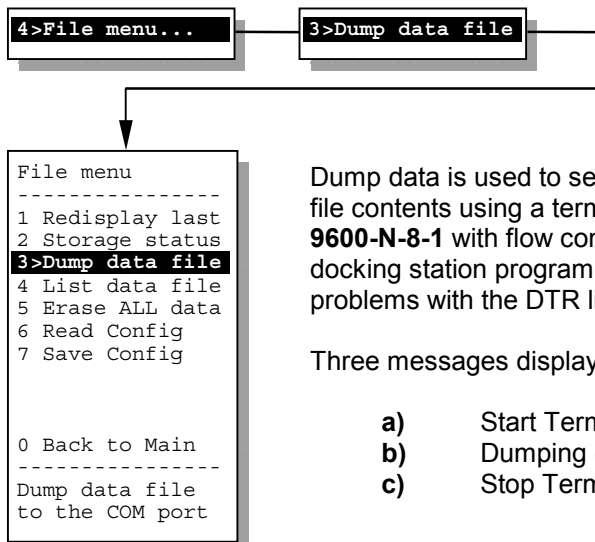

Dump data is used to send data directly to a serial printer or export the data file contents using a terminal program. Default setting of the terminal is **9600-N-8-1** with flow control off. The baud rate can be changed via the docking station program. This procedure should be followed to prevent problems with the DTR line activating the start button.

Three messages displayed during this procedure:

- a) Start Terminal then Press **0**
- b) Dumping data **0** - Cancel
- c) Stop Terminal then Press **0**

2.28.4.4 List data file *List contents of data file*

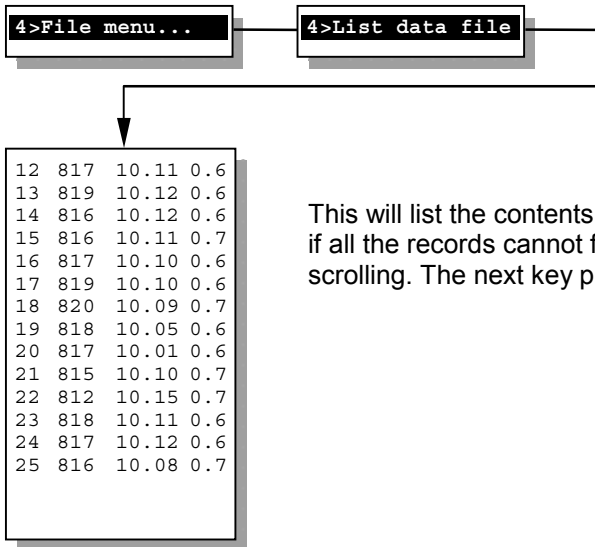

This will list the contents of the data file on the screen. The screen will scroll if all the records cannot fit on one page of the display. Press **0** to stop the scrolling. The next key press will exit back to the file menu.

2.29.4.5 Erase data *Clears contents of data file*

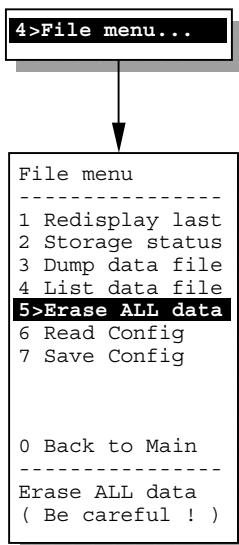

This will clear all the records currently held in the data file. Press **ENTER/START** to confirm erasing file or **0** to cancel command. Once erased the data file cannot be recovered.

2.30.4.6 Read Config
Loads the stored configuration file

```

4>File menu...
    |
    v
File menu
-----
1 Redisplay last
2 Storage status
3 Dump data file
4 List data file
5 Erase ALL data
6>Read Config
7 Save Config

0 Back to Main
-----
Read Config.
from file
    
```

The configuration file holds all the parameters that setup the SMT-200. The file is automatically loaded and saved on power up and shutdown. Read config will reload the parameters that the unit powered up with or the parameters that were saved on the last Save Config command.

2.31.4.7 Save Config
Saves the configuration file

```

4>File menu...
    |
    v
File menu
-----
1 Redisplay last
2 Storage status
3 Dump data file
4 List data file
5 Erase ALL data
6 Read Config
7>Save Config

0 Back to Main
-----
Save Config.
to file
    
```

Writes (saves) the current configuration to file in the non-volatile memory (flash disk).

2.32.6 About

Provides general information about the SMT-200

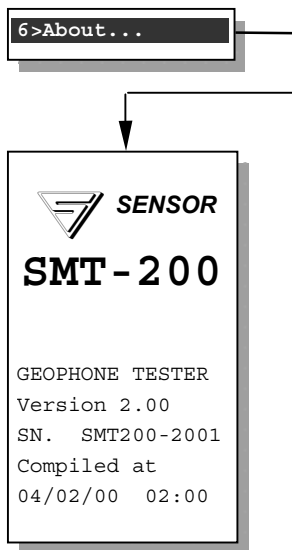

“**Version**” shows the software revision of the code.

“**SN**” gives the serial number of the unit.

“**Compiled at**” gives the date and time of when the software was compiled.



Section 3

Docking Station

&

PC Software Operations

Page intentionally left blank

3.1 Docking Station overview

The Docking station has two main functions:

- Battery charging.
- Interfaces SMT-200 to PC for data exchange and software updates.

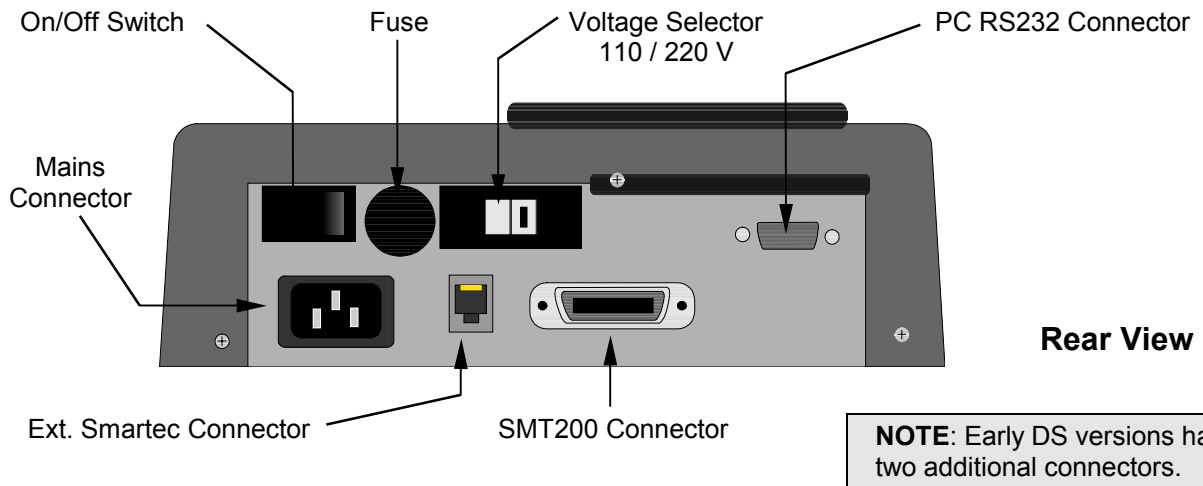
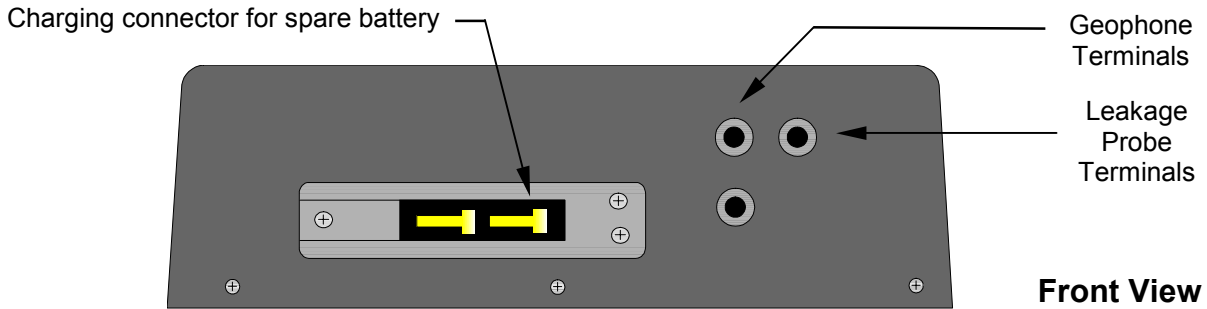

3.2 Docking Station interconnection

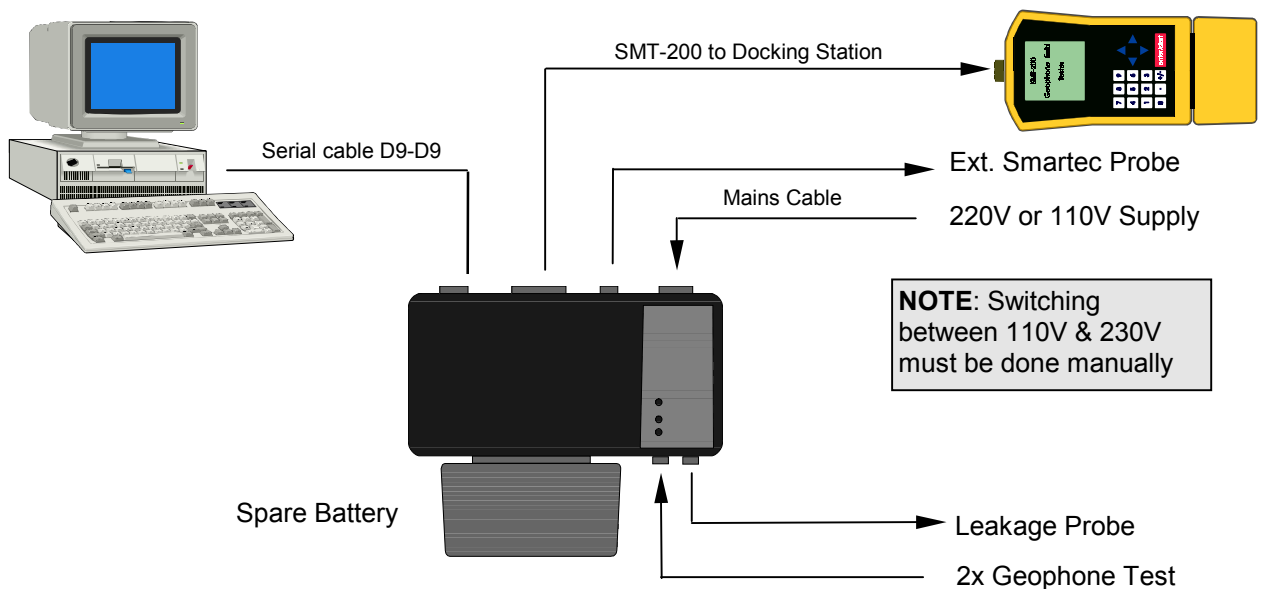

3.2.1 Battery Charging

The Docking Station has two completely independent charging circuits. One circuit is for the spare battery. This connects to the front of the Docking Station. The battery slides onto the mount so the contacts mate together. The other circuit is for the battery on the SMT-200 and connects via the rear Centronics 24 Way connector to the SMT-200 main connector. The batteries can be charged independently or at the same time. Charging status for each battery is shown by the LEDs on the Docking Station.

- Power on
- Charge circuit 1 (main battery)
- Charge circuit 2 (spare battery)

LED COLOUR		
RED	ORANGE	GREEN
Maximum charge rate	Controlled charge rate	Trickle charge

When a battery is connected to either charging circuit the Docking Station charging circuits will assess the battery state. If the battery is in a discharge state it will apply a full rate charge which will be indicated by the charge LED illuminating red. This reduces the time needed to charge the battery to a minimum. Once the battery has reached approximately 95% of its full capacity it will switch to a current monitored mode. This state is indicated by the LED illuminating orange. Once the battery has received a full charge the charging current is reduced to a minimum to keep the battery topped up. This state is known as trickle charging and is indicated by the LED illuminating green. In this state the battery is fully charged and can be removed from the Docking Station. No harm will result if the battery is left to the Docking Station on a trickle charge indefinitely.

A fully discharged battery will take approx. 3 to 4 hours to recharge. If the battery is attached to the SMT-200 and the SMT-200 is in use this time will increase. This is simply because part of the available charging current is being used to drive the SMT-200 electronics.

NOTE: Geophone testing is not recommended while connected to the docking station.

Once charged the battery should give up to 4 hours of operation in normal use before it needs to be recharged. This depends on a number of factors. More current is consumed when a test is being performed and excessive use of the backlight will reduce the operational time available before recharging is required.

In normal use the SMT-200 will monitor the state of the battery and will automatically shut the unit down if the battery voltage drops below 10.7 V. If this happens the SMT-200 battery should be recharged as soon as possible.

If the docking station is on when the battery is connected there is a chance that the charging circuit may need to be reset to initiate the fast charge cycle. To do this simply turn the docking station off, wait a few moments and then turn on again.

3.2.2 PC Interface

The other function of the Docking station is to interface the SMT-200 to a PC. To connect the SMT-200 to the Docking Station for data downloading or recharging it is advisable to first ensure the power is off on the docking station and SMT-200. Connect the PC to the docking station with the 9 pin D9 to D9 connector supplied. Next connect the SMT-200 to the docking station with the Bendix to Centronics 24 way cable supplied. Switch on the power to the docking station. If there is a battery connected to the SMT-200 the LED on the docking station will illuminate after a short pause and indicate the status of the battery. Start the software on the PC.



3.3 Docking Station PC software introduction

The Docking Station software allows you to:

- Download the data file from the SMT-200.
- Synchronise the SMT-200 date and time with PC's date and time.
- Upload SMT-200 configuration and specifications files.
- Upload SMT-200 software upgrades.

3.4 Software installation

The program can be run under Windows 3.xx, Windows 95 / 97 or DOS 5.0 or higher. The program will **not** function when run with Windows NT.

3.5 Windows installation

This is the preferred installation method (example shown is for a Windows 95 installation).

1. Insert the Disk into drive A:
2. In Windows, choose **Run** from the Start (or file) menu, type **a:\setup** and click **OK**.
3. You will be prompted for the directory to install to. Click Continue when done.

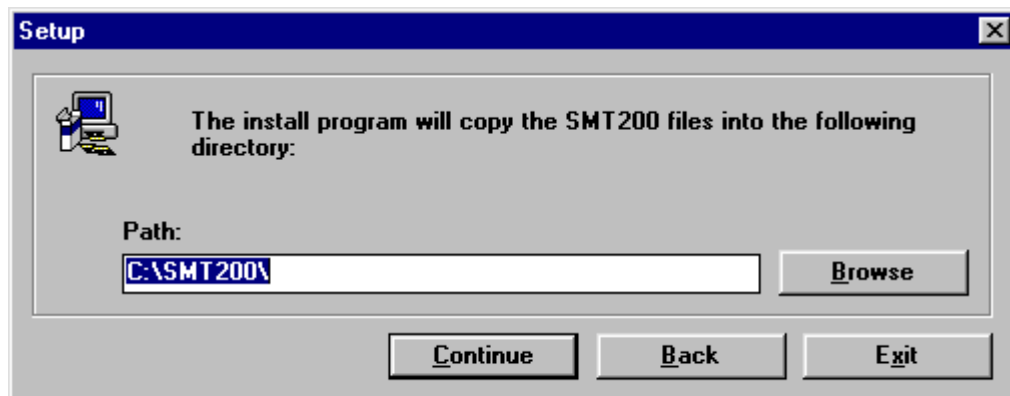

4. The required files will be decompressed and copied to the hard disk.

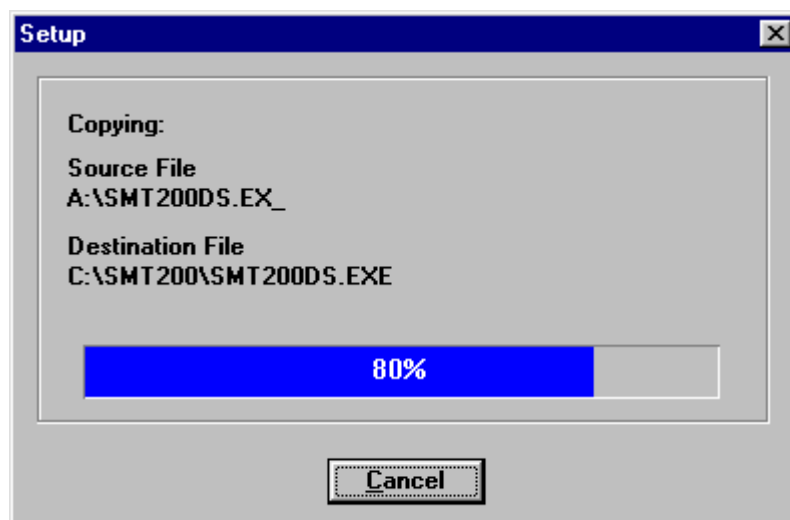

5. You will be asked if you want create a Program Manager Group. It's strongly recommended to have a Program Manager group. This will make it easier to start and un-install the program at a later date if required.

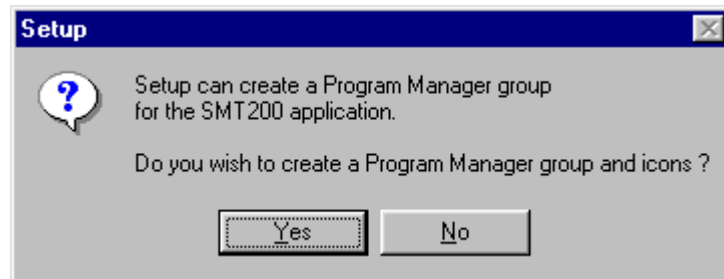

3.5.1 Windows un-install

If the software needs to be removed from the hard disk use the following procedure.

1. Select the Un-Install from Windows SMT200 menu option.

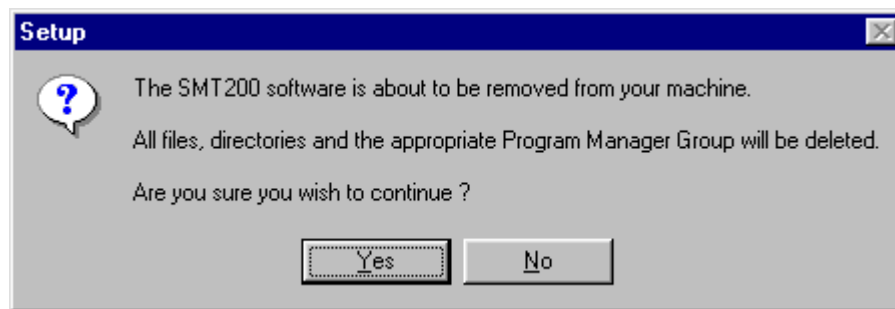

This will remove all the SMT-200 Docking Station software components apart from the DATA directory and file transfer history files.

3.6 DOS installation

1. Insert the Disk into drive A:
2. Type **A: Return**
3. Type **INSTALL Return**
4. Follow the instructions on the screen. The prompts will be similar to the windows installation.

3.6.1 DOS un-install

The program files need to be removed manually using the DOS comands Del and Rmdir. Please consult your DOS manual for further details. Note SMT-200 data is stored in a separate directory.



3.7 Running the program

Windows: Double click the Icon in the SMT200 program group.
 DOS: **C:\SMT200\SMT200DS** Return

This will bring up the main SMT-200DS menu as described below. If the program is running from Windows the display will switch to text or test box mode. The mouse should be able to access the SMT-200DS options in DOS (if the mouse driver is loaded) and Windows 95.

The diagram illustrates the menu structure of the SMT-200DS program. Three separate menu boxes are shown, each with a list of options and their corresponding keyboard shortcuts. Arrows from these boxes point to a terminal window that displays the program's main menu and configuration information.

Information...	Alt-I
Help...	F1
Settings...	
Exit	Alt-X

Save configuration...	F2
Retrieve configuration...	F3
Data file name...	F4
View file...	Alt-U
Print file...	Alt-P
Copy file...	Alt-C
Erase file...	Alt-E
Information on files...	

Operating...	F5
Geophone specs...	F6
String...	F7
Tests...	F8
COM settings...	
Data Download...	Alt-D
File Transfer...	Alt-T
Tag file upload...	Alt-L
System Update...	Alt-U

```

SMT-200DS File SMT-200 Wed 3 Nov 1999 12:18:43
SMT-200DS Docking Station Version 2.00 Serial nr. 0
General Configuration Information
Parameters tested: Resist. Freque. Distor.
Configuration file = C:\SMT200\SMT200.CFG
Data file = DATA0.PRN
Geophone Spec Name = Sensor-SM4
Temperature = 20.0 °C
Not shunted
Series = 1
Parallel = 1
Total cable resistance = 0 Ω
F1 Help Alt-X Exit Alt-N Next F10 Menu 99328
  
```

- F1** Access help on selected item
- Alt-X** Terminate the program
- Tab** Move the next field
- F10** Activate menu at top of screen

The **Function** keys and the **ALT** give you a keyboard shortcut to menu items. Select functions by using **F10** together with the menu item coloured letter. Menu items that have three dots (...) following the description have an associated submenu.

3.7.1 SMT-200DS menu

Information...	Alt-I
Help...	F1
Settings...	
Exit	Alt-X

The **SMT-200DS** menu allows you find the Docking Station version and serial number under the **Information** option. The **Help** gives some general advice on use of the software. Specific help can be found by moving the hi-light to the option in question and hitting the **F1** key. **Settings** allows you to change the COM port and the colour mode (Colour or Monochrome) of the screen. **Exit** will terminate the program.

3.7.2 File menu

Save configuration...	F2
Retrieve configuration...	F3
Data file name...	F4
View file... Alt-U	
Print file... Alt-P	
Copy file... Alt-C	
Erase file... Alt-E	
Information on files...	

The **File** menu allows you to save all the current settings to a configuration file (**Save configuration**). These will always have a file extension of CFG. The default is SMT200.CFG. These can be used in any subsequent session by using the **Retrieve configuration** option. **Data file name** specifies the file to which test results are written. There are also some general file handling commands that allow you to **View**, **Print**, **Copy** and **Erase** data files. **Information on files** provides a summary of directory and file locations of all files used or selected.

3.7.3 SMT-200 menu

Operating...	F5
Geophone specs...	F6
String...	F7
Tests...	F8
COM settings...	
Data Download...	Alt-D
File Transfer...	Alt-T
Tag file upload...	Alt-L
System Update...	Alt-U

The **SMT-200** menu gives you option to change various test and SMT-200 parameters. The individual menu items are a duplicate of SMT-200 menu items and are covered in detail in Section 2.

Com settings allow you to adjust the baud rate for data transfer over the com port. This is only used if you want to dump data to a serial device such as a serial printer at a different baud rate than default. The SMT-200 user cannot change data rates for transfer between the SMT-200 and Docking Station.

Data Download will only download the test data stored in the SMT-200. Initially the file name given is TEMP.PRN but the user is given an option to change this.

File Transfer will decide if the current configuration needs to be uploaded. It does this by checking if the time and date of the current CFG file is newer than the one stored in the SMT-200. After this, stored SMT-200 test data is downloaded to the PC. Initially the file name given is TEMP.PRN but the user is given an option to change this. See 3.11.

Tag file upload please see Appendix D for detail on this feature

System Update is used to upload new SMT-200 software. The version of code held on disk will be copied to the SMT-200 if newer than the software already loaded in the SMT-200.



3.8 Data Exchange

Transfer of the files is automatic. Data exchange is divided in four options:

- Regular data File Transfer.
- System Update, which allows the current program in the SMT-200 to be overwritten with a newer version.
- Data download
- Tag file upload

3.8.1 Instructions for File Transfer

- Connect the Docking Station to the SMT-200 and to the mains power supply.
- Switch ON the Docking Station.
- Leave the SMT-200 switched OFF.
- Start the Docking Station program (See section 4.6).
- Close the Opening Info window by pressing **ENTER**, (it times out after 10 s).
- Select file transfer with **Alt-T**.
- The SMT-200 will be powered-on and start the file exchange.
- Once the exchange is successfully completed the program prompts you to 'Save DATA as'.
- After the file transfer the program suggests a new data file name.
- You can confirm this name by pressing **ENTER** or edit it to your choice of name. If there is no user intervention, after 1 minute the program will time out and save the file under the suggested name.

3.8.2 Explanation of Data transfer sequence:

During transfer the file is saved on the PC's disk as TEMP.PRN. If a file with that name exists it is deleted before transfer starts. When the exchange is successful and TEMP.PRN has been written the program prompts the user to "Save DATA as". In fact the file has already been saved and this prompt is to rename the data file to give it a proper name.

The naming convention is "DATAxxxx.PRN" where xxxx is a value between 0000 and 9999. The program first looks for the name in SMT200DS.CFG and increases xxxx by 1. Then it looks for any files which exist and adhere to the convention that the highest xxxx + 1 is the new name presented to the user.

The user can edit this or enter a completely new name.

The user confirms this name by pressing **ENTER**. If there is no user intervention, after a time-out of 1 minute the program will automatically finish the rename. The data is then saved under the default name.

After completing the File Transfer sequence the SMT-200 will be switched off automatically.

NOTE: If the configuration or the geophone specification file (**SMT200.CFG & SPC.TXT**) on the PC are a later date than the same file in the SMT-200 they will be automatically updated from PC during the File Transfer sequence. This may overwrite and thus alter test specs. in the SMT-200. It is generally recommended to change test specs. from the Docking Station program.

3.8.3 The SMT-200 During File Transfer

Phase 1:

Upl INFO200.TXT 8 Blocks CRC	<i>Uploading the files status from the SMT-200 Only this file is sent in 128 byte blocks</i>
COM1,19200 baud Mem: 325904	<i>at 19200 baud free memory</i>

Phase 2:

Dnl INFOHOST.TXT 0 Blocks CRC Received #	<i>Downloading a script file from the PC Host all files are sent in 1k blocks with CRC checking</i>
COM1,115200 baud Mem: 281872	<i>at 115200 baud free memory</i>

Phase 3:

Time and date are synchronised

Phase 4:

All files to be updated are processed in the same way

3.8.4 Failing Transfers

A failing transfer can have several causes:

- Incorrect COM port selection, try another COM port (i.e. select COM 1 or COM 2).
- The SMT-200 to Docking Station cable is not connected properly.
- Docking Station's power is off: the SMT-200 will be switched on however, but the communications circuit needs power.
- PC is not ready, i.e. other processor tasks are taking too long, causing time-out errors. Preferably run the Docking Station software under DOS if transfer problems are found. It has been proved that it will work successfully under Windows 3.1. Windows 95 will run the software but this has been found to be system dependent. Try running the software in MS-DOS mode.
- Some problems have been encountered with incompatible serial interface controllers on certain computers. If all the above fails then try a different computer, if available.



3.9 System Update

3.9.1 Instructions for System Update



When you upload new system software and the transfer fails **never switch off the SMT-200 by disconnecting the battery or powering down the Docking Station.** You **must** let the SMT-200 time-out by itself. This takes about 1 minute.

The instructions for System Update are the same as for File Transfer except that the Docking Station program asks you for confirmation when you've chosen this command.

Technical Note:

When downloading a file from PC to the SMT-200, the old version is put into the free memory first. If transfer fails then it is restored. When transfer fails within a minute the SMT-200 will reboot. This is the reason why it **could be fatal** to interrupt a failing transfer by just switching off the power and/or disconnecting the battery.

3.9.2 Failing System Updates

For possible reasons of failing transfer check the Failing Transfer in the file Transfer section. In addition check that the version you are trying to upload is a later date than the one current in the SMT-200. If it's older it won't be transferred.

3.10 The SMT-200 Geophone Specifications File

The file SPC.TXT is used by the SMT200. It can be changed so that it contains your own choice of geophones. This can be done using the geophone specifications editor built into the Docking Station software. Alternatively this can be done directly from the SMT-200. An example of the contents of a SPC.TXT file is shown below.

```
"Sensor-SM24", 375, 10.00, 28.8, 0.250, 0.0020, 0.10, 12.00,11.0, 2.5, 2.5, 2.5, 2.5, 2.5, 2.5, 0.0, 5.0, 20.0
"Sensor-SM4", 375, 10.00, 28.8, 0.250, 0.0020, 0.20, 12.00,11.0, 5.0, 5.0, 5.0, 5.0, 5.0, 5.0, 5.0, 20.0
"Sensor-SM4-HS", 375, 10.00, 28.8, 0.250, 0.0020, 0.10, 12.00,11.0, 2.5, 2.5, 2.5, 2.5, 2.5, 2.5, 0.0, 5.0, 20.0
"Sensor-SM4-LD", 375, 10.00, 28.8, 0.250, 0.0020, 0.10, 12.00,11.0, 5.0, 5.0, 5.0, 5.0, 5.0, 5.0, 5.0, 20.0
```

TIP: If modifications to the geophone specification file are made from the SMT-200 these may be overwritten during the next data transfer session. It is better to modify the specs. in the Docking Station program via the data transfer cycle to upload to the SMT-200.

Page intentionally left blank



Section 4

RFID Tag Reader

Page intentionally left blank

4.1 RFID Tag reader introduction

When testing geophones strings using the SMT-200 a test identification or the string number must first be allocated to each string test. This number can normally be found as an ID label attached to the string. The identification label has to first be located and the identification number then entered in to the SMT-200 before commencing with the actual geophone string test. This is a time consuming practice and is a possible source of errors.

However by using the RFID tag reader this process is much faster and it's impossible to enter an incorrect string number. Just point the tag reader at the tag, pull the trigger and it reads the string number and automatically starts testing. Fast and error free.

4.2 Principles of the RFID Tag reader

The tag reader consists of a low power radio transmitter and receiver together with a microprocessor for interpreting and conditioning the signals. The tag consists of an integrated circuit (IC) containing a unique number and a wire antenna. Both are encapsulated in a small round epoxy package. This tag can be attached to the string cable in a special 'key-hanger'.

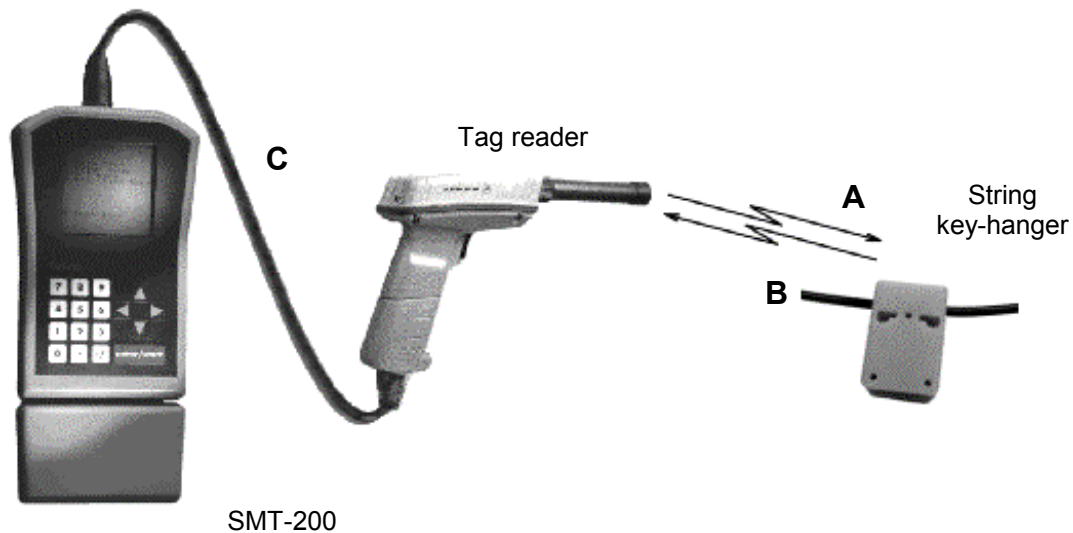

Activate the tag reader by pulling the trigger. A magnetic field is generated by a RF current passed through its antenna.

When the reader is close enough proximity to the tag, a current is induced in it's coil and the IC continuously transmits it's unique number back to the radio receiver in the tag reader until read.

The tag number is send via an RS232 link to the SMT-200.

4.3 Working with the RFID Tag reader

To test strings using an SMT-200 with tag reader takes three steps:

- Read tags to create a tag list containing the tag ID and associated string number.
- Test the geophone strings.
- Download the data file to the PC.

4.3.1 Read tags

A tag ID number is comprised of 13 digits. As this is a large amount of digits and the user may have specified string numbers, a cross link table (tag list, containing the tag ID and allocated string number) must first be composed. It is advisable to create this table prior to commencing with testing.

```

Main menu
-----
1 Do a test...
2 Setup menu...
3 Temp. menu...
4 File menu...
5>Tag menu...
6 About...

0 Shut down
-----
Submenu for
RF/ID tags
    
```

```

Tag menu
-----
1>Read tags
2 Taglist

0 Back to Main
-----
Read
RF/ID tags
    
```

The SMT-200 has a special menu for the tag reader. In the **Main menu** you will find the submenu **Tag menu**.... When you enter this menu you will see two items. **Read tags** and **Tag list**. Enter the **Read tags** item to make a cross link table.

```

Read tags
-----

-----

Read next Tag
Enter Change No.
0 Back to Tag
    
```

In this menu you can read tags and assign or change the string number. Point the tag reader antenna at the tag and pull the trigger. The tag reader beeps when the tag number is acquired.

```

Read tags
-----
Tag
1000103306812

String No.
214

NEW

-----

Read next Tag
Enter Change No.
0 Back to Tag
    
```

Once read, the tag ID is displayed under the text *Tag*. If it's the first time this tag has been read the text *NEW* appears. A default string number is assigned to the tag ID. The default number is the previous 'new' string number plus one. This is may not be the string number you wish to allocate to this tag ID. To change the string number press **ENTER/START**.



```

Read tags
-----
Tag
1000103306812

String No.
2

NEW

-----
Read next Tag
Typ new Str. No.
1/99999

```

Using the SMT-200 keypad, enter the required number. This number will be displayed under the text *String No.* If you make an error you can use the left arrow to erase the last digit. If the default number is the string number you want to assign confirm by pressing **ENTER/START**.

The highest possible string number is 99999.

You can now read tags one after another. If a tag is read that is already stored in the tag list the corresponding string number will be displayed. By pressing **ENTER/START** you can change this string number.

4.3.2 Test the strings

```

Main menu
-----
1>Do a test...
2 Setup menu...
3 Temp. menu...
4 File menu...
5 Tag menu...
6 About...

0 Shut down
-----
Enter test mode

```

```

String config.
-----
[Sensor-SM4]
Temp [20.0 °C]
Series [1]
Parallel [1]
Not shunted
Next# [1 A]

Estimated space:
3276 Records

-----
0 Back to Main
- Repeat Test
Start next Test

```

```

--Test results--
No. 1
Temp 20.0 °C
Res 382 ohm
Freq 9.91 Hz
Damp 0.259
Sens 28.7 V/m/s
Dist 0.04 %
Imp 2205 ohm
Test OK

-----
0 Back to Main
- Repeat Test
Start next Test

```

To tests geophone strings enter **Do a test...** in the **Main menu**. An overview is displayed of the string configuration. Bypass this screen by pressing **ENTER/START**.

To start a geophone test connect the string to the SMT-200. Aim the tag reader at the tag and pull the trigger. If the tag is known the corresponding string number is displayed and the geophone test is started.

For security and quality control reasons, it is not possible to change the string number from this menu. However, should a 'new' tag be read a string number must be allocated to it. A screen just like the 'read tags' screen (as described earlier) pops up and the default number can be accepted or another string number allocated. Confirm the string number by pressing **ENTER/START**, the tag ID and string number is stored in the tag list and the test is started.

Should a string be encountered without a tag a string number can be manually allocated via the SMT-200 keypad.

4.3.3 Transfer data file

Upon completion of testing, test data can be downloaded to the PC via the Docking Station program. Connect the SMT-200 to the PC and start the Docking Station program. Select the menu option **SMT-200, File Transfer**. The SMT-200 now downloads the data file to the PC.

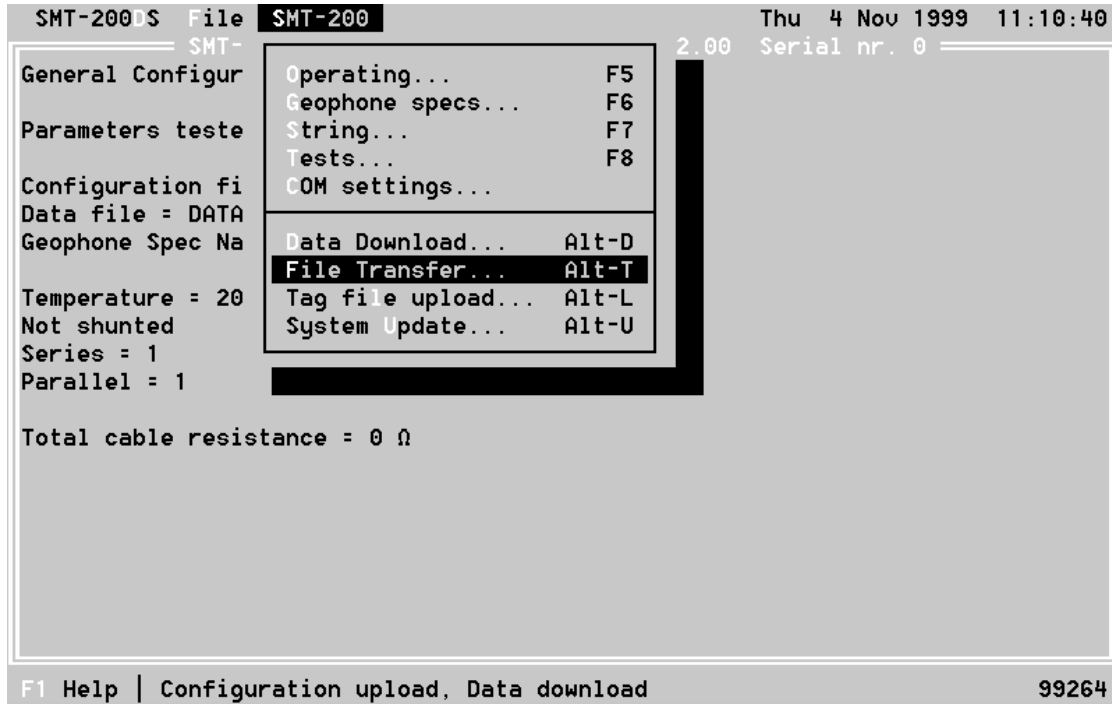

The data file is a text file that can be opened using any text editor. It is also possible to open the file using a spreadsheet program. In the Docking Station program you can select the menu **File, View File....** A form is displayed where you can select the data file you want to view. The data will be displayed in columns.

Starting at 26-11-99 12:36:21 NoNA
 SMT-200 Geophone Tester Version 2.00 Serial nr. 2001

Spec	Ser	Par	Shunt	Mass	Fdist	VelDist	Excur	DataCorr	Tests		
Sensor-SM4	6	2	1000	11	12	0.7	0	1	ABC		
Tested:	Res	Freq	Damp	Sens	Dist	Imp	RC	Reject:	Temp	Time	Tag Number
Min:	777	9.50	0.652	119.4	0.00				@20.0		
Nom:	818	10.00	0.686	125.7		2143					
Max:	859	10.50	0.721	132.0	0.20						
Num:	ohm	Hz		V/m/s	%	ohm			°C		
1	793	9.90	0.706	167.2	0.19	2097	23	Test OK	21.6	12:37:06	
2	854	10.52	0.662	166.9	0.10	2260	23	Test OK	21.6	12:37:21	
3	842	9.80	0.667	161.7	0.08	2227	23	Test OK	21.6	12:37:34	1,000,103,287,679
4	821	10.28	0.668	165.8	0.22	2171	23	Test OK	21.6	12:37:47	1,000,002,268,681
5	788	10.31	0.707	170.8	0.06	2084	23	Test OK	21.6	12:38:02	1,000,103,287,512
6	787	10.25	0.660	164.5	0.13	2081	23	Test OK	21.6	12:38:15	1,000,105,222,156
7	804	9.84	0.710	167.2	0.12	2127	23	Test OK	21.6	12:38:28	1,000,103,555,668

Ended at 26-11-99 12:39:49

The only difference between the normal format and the one with the tag reader is the column **Tag Number**. If the test was initiated by the tag reader the tag number is displayed in this column. If the string number was entered manually, no tag number appears in the last column.

4.4 Sorting the tag list

The tag list consists of two sections due to its huge capacity (up to 120,000 tags), a sorted and an unsorted part. When tags are read the numbers are sequentially stored in the unsorted section of the tag list.

Should the unsorted list become very large there may be a delay before the string number displayed after reading the tag. If this should occur then it is advisable to sort the list.

Sorting the tag list is very easy. Each file transfer the unsorted part of the tag list is downloaded to the PC and stored as a text file. When you upload this file from the PC to the SMT-200 it is automatically sorted. See the paragraph download tag list and upload tag list for more information.

4.4.1 Download the tag list to the PC

Each file transfer the unsorted part of the tag list is downloaded to the PC. Select in the Docking Station program the menu item **SMT-200, File Transfer** for a file transfer. The tag list is stored under the name 'Tagxxx.txt'. xxx represents the serial number of the SMT-200. The file is located in the subdirectory \SMT200\TAGS.

When a file with your serial number already exists, the unsorted part of the tag list is appended to this file. By this, you always have a copy of the tag list in the PC.

4.4.2 Upload the tag list to the SMT-200

The menu **SMT-200, Tagfile upload** gives a new form where you can select a tag file that you want to upload to the SMT-200.

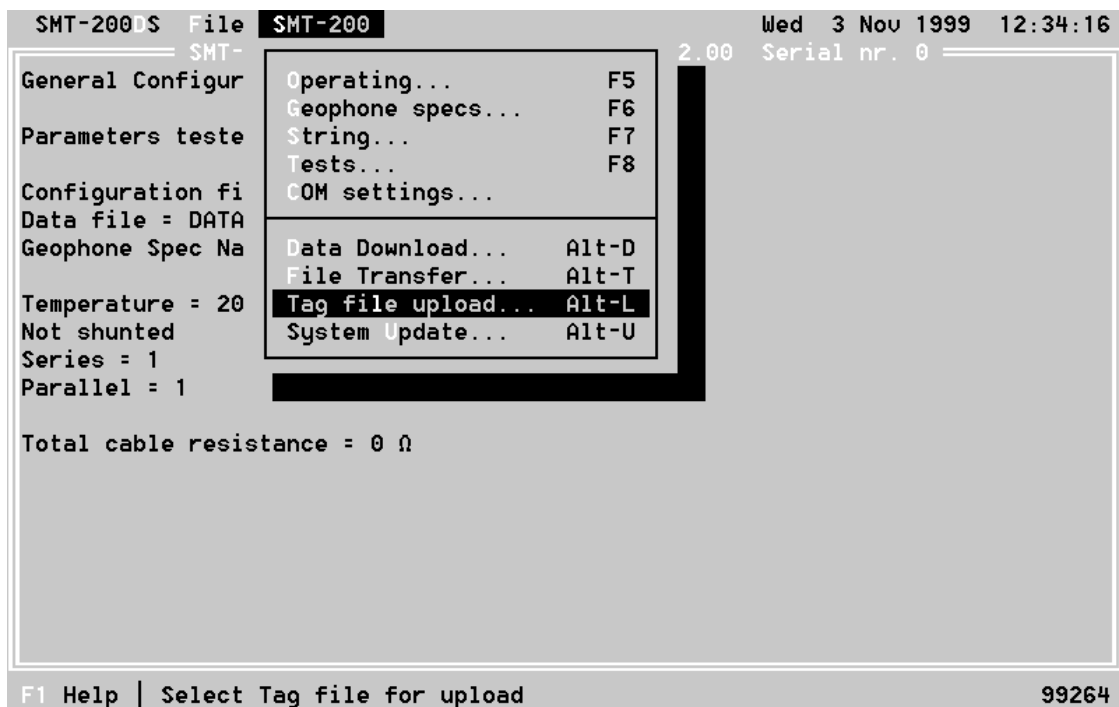

Default are visible the files with extension *.txt in the \SMT200\TAGS directory.

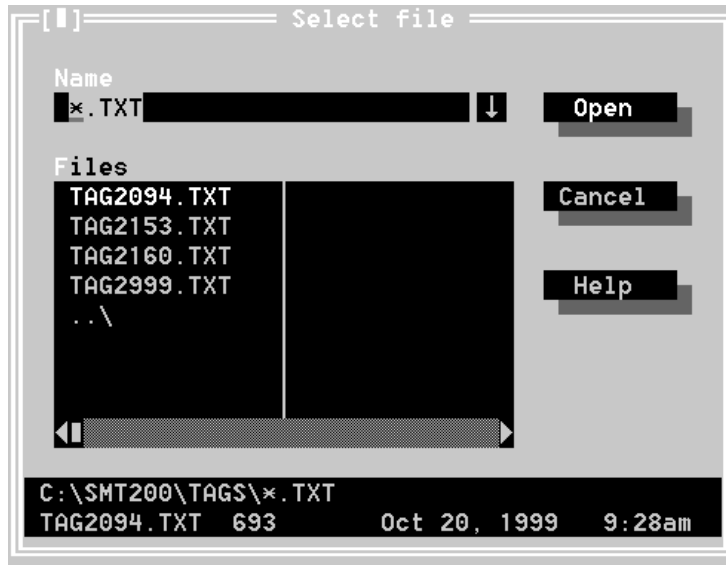

Select a file and press the button **Open**, the Docking Station then starts sorting the file. This may take some time when a large file is selected. A 'busy' message is displayed. You can quit by pressing **Esc**.

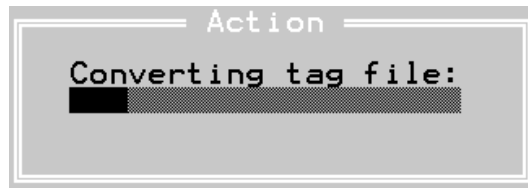

After the conversion is finished, a report is displayed where error messages are displayed. Normally there will be no messages. The tags displayed in the conversion report are removed from the converted list.

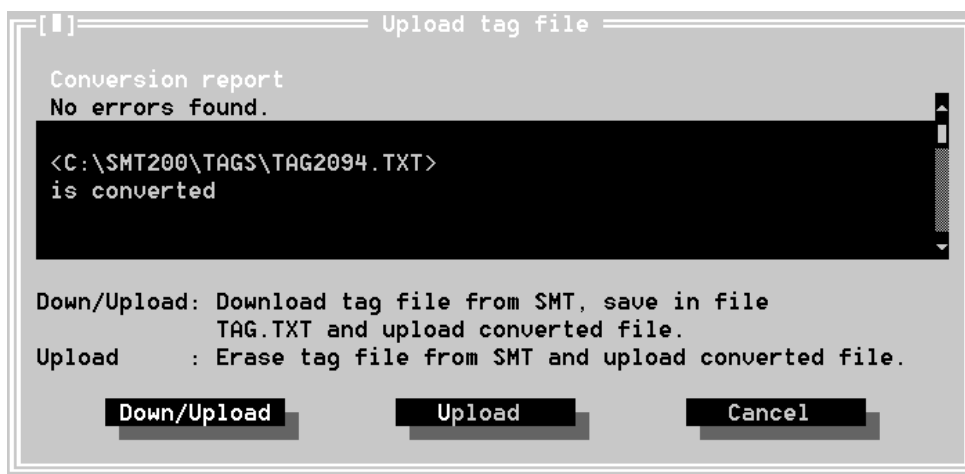

In this form you can choose from three buttons:

With **Down/Upload**, the unsorted tag list is downloaded to the PC and stored as 'Tag.txt' in the \SMT200\TAGS directory. After this, the tag list is removed from the SMT-200 and the converted file is uploaded and stored as the tag list in the SMT-200.

The file 'Tag.txt' can be renamed by the user if the 'old' tags must be saved.

By pressing the **Upload** button, the tag list is removed from the SMT-200 and the converted file is uploaded and stored as the tag list in the SMT-200.

Cancel quits the form without any further action.

4.4.3 View the tag list on the SMT-200

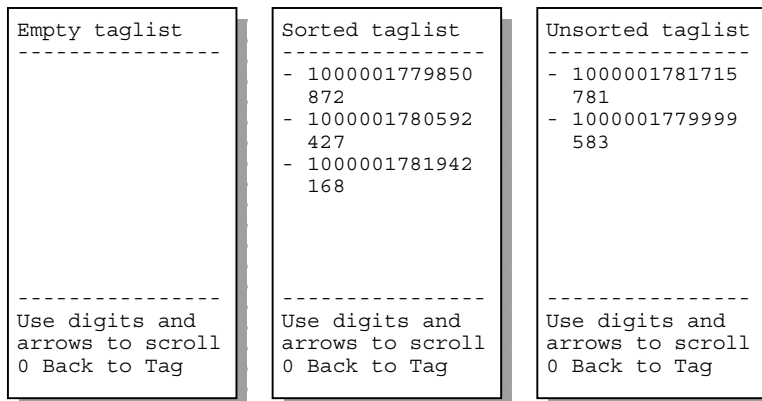

From the **Main menu** select **Tag menu...**, then **Tag list**. An overview of tags and corresponding string numbers is displayed. In the first section the sorted part of the list is displayed.

Using the up and down arrows to scroll through the page. When you reach the end of the sorted list you can go to the unsorted part by pressing the down arrow. In the top line of the screen sorted or unsorted list is displayed. With the left and right arrow you can step between the start of the sorted and unsorted list and to the end of the list.

When you type a number, the SMT-200 searches in the sorted list for the first tag that is equal or greater. You can remove the last digit with the left arrow. Leave this option by pressing the right arrow. Press the up or down arrow if you want to leave this option and immediately scroll a page. If there is no sorted tag list the beginning of the unsorted list is shown.

Press a **0** to quit this menu item. If you are entering a tag ID the **0** does not quit the menu item but adds a 0 to the tag ID, you can use the **.** instead.

4.4.4 View the tag list on the PC

The tag list is stored as a text file, and can easily be opened by a spreadsheet program or a text editor. From the Docking Station program select the menu item **File, View File...**

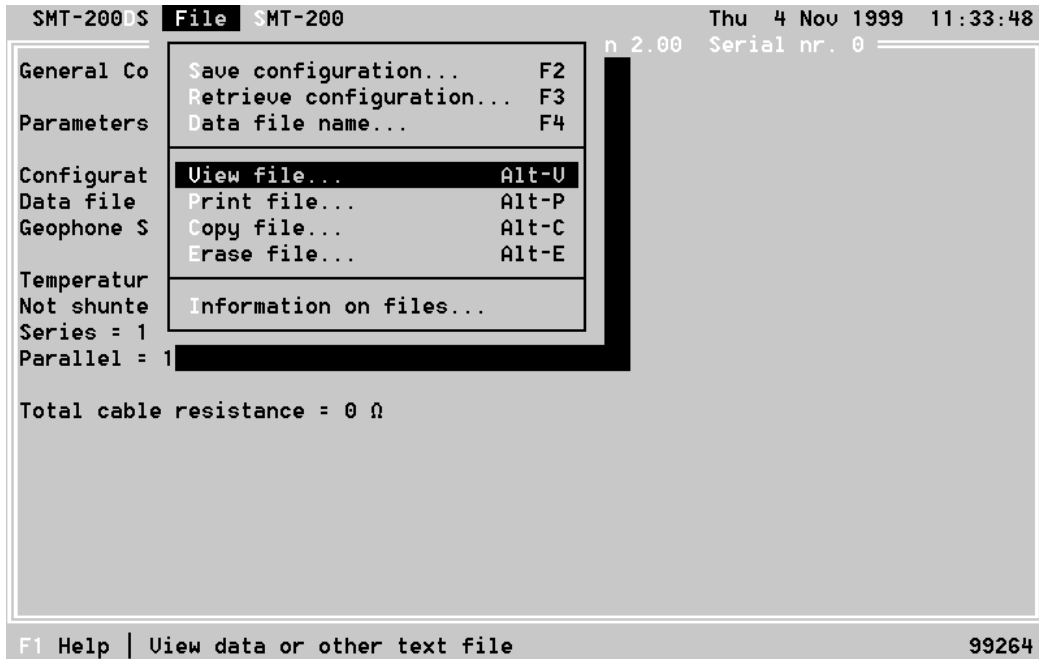

a new box is displayed where a file can be selected to view. Tag files are located in the subdirectory \SMT200\TAGS.

Type in the input line **Name** the text:

..\Tags*.txt

Click on the **Open** button or press **Enter**. This will select the correct subdirectory and the files with the right extension are displayed.

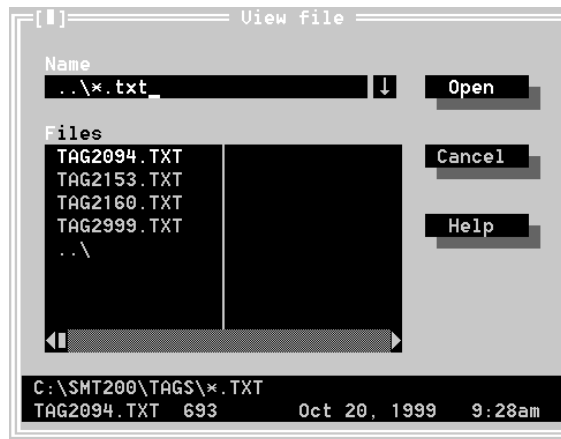

Select the required file for viewing by clicking on it with the mouse. Click on the **Open** button or press **Enter**. The tag list will be displayed.

1000001779850	872
1000001779999	583
1000001802291	103
1000001802292	804

The left hand column contains the tag ID and the right hand string numbers entered by the user.

4.5 Settings

4.5.1 COM settings

When using the Tag reader the SMT-200 baud rate can be set in the menu **SMT-200, COM settings**. The tag reader baud rate must be set to 9600 baud.

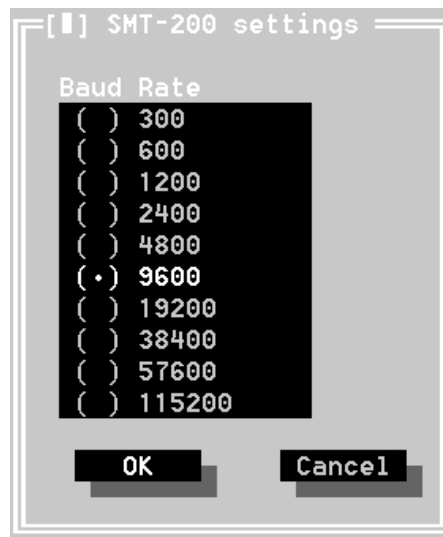

4.5.2 Autonumber

When the Autonumber option is ON and you are testing a 'new' tag, the SMT-200 assigns a string number and starts testing immediately.

If you want to enter in the string number manually the Autonumber setting should be set to OFF.

4.5.3 Tag menu visible

In the menu **SMT-200, Operating** there is a checkbox **Tag menu** under the **System** label. Use this option to enable the tag menu in the SMT-200.

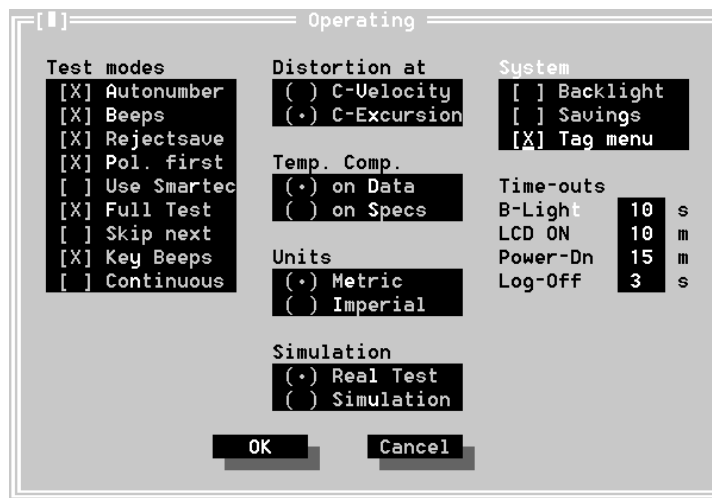

4.6 Internal storage

With the SMT-200 and a RFID tag reader you can read unique, 40 bits, tags. The user can link a variable string number to it ($1 \leq \text{String number} < 100.000$). The maximum amount of tags is 120.000. Different tags can have the same string number, so the string number does not have to be unique.

When a 'new' tag is read it is stored in an unsorted binary file. The unsorted binary file will be downloaded to the PC with a file transfer. This file will be appended to the binary file 'Tagxxxx.bin' and converted to the ASCII file 'Tagxxxx.txt'. xxxx represents the serial number of the SMT-200. Both files are stored in the subdirectory \SMT200\TAGS. The ASCII file is stored in TAB format, so it can easily be opened by a spreadsheet program or text editor.

From the Docking Station program you can select an ASCII file to upload to the SMT-200. This file is converted to binary format, sorted and checked on errors (double or too high tag ID's) before it will be uploaded. The sorted, 'cleaned' list is stored under the name 'TagSo.txt' in the \SMT200 directory.

With a **Down/Upload**, the unsorted tag file in the SMT-200 is downloaded and appended to the file 'Tagxxxx.bin' first (as described before). The belonging ASCII file is stored as 'Tag.txt' in the \SMT200\TAGS directory. After this, the unsorted file is removed from the SMT-200 and the converted file is uploaded and overwrites the sorted file in the SMT-200.

The file 'Tag.txt' can be renamed by the user if the tags must be saved.

With an **Upload** the unsorted tag file will be removed from the SMT-200 and the sorted file will be replaced.

If later new tags are read, a new unsorted binary file is made to store these.



Section 5

Geophone Testing

Page intentionally left blank

5.1 Preparing the SMT-200 for use

Before configuring the SMT-200 to test a new type of string ensure the full details of the string are known, including:

- geophone type (specification).
- damping resistor value (if installed).
- number of elements in series connection.
- number of elements in parallel connection.
- case interval.
- lead-in.
- connector polarity.

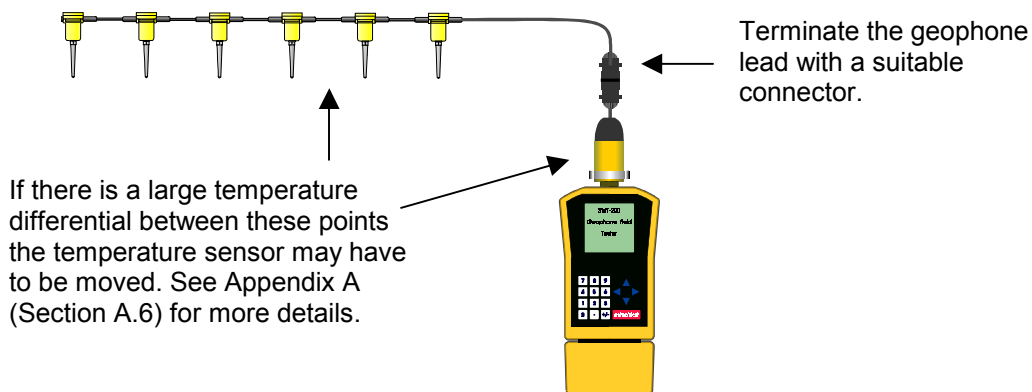

First thing to do is check that the geophone type is in the SMT-200 library. If the geophone type is not listed in the SMT-200 library copy it from another geophone description and edit the required parameters accordingly.

1. Switch on.
2. Select **Setup menu 2**.
3. Select **Geophone menu 2**.
4. Go to **Select menu 1**.
5. Place the cursor alongside the geophone specification for the elements in your string.
6. Hit **ENTER/START** to select the required element.
7. Type **0** to return to the **Setup menu**.
8. Select **String menu 1** to set your string characteristics.

```
String menu
-----
1>No. 26
2 Series 12
3 Parallel 1
4 Rcab 126 Ω/km
5 Interval 5.0 m
6 Lead-in 10.0 m
7 Use Shunt? no
8 Shunt 1000 ohm

0 Back to Setup
+ Imp/Met-----
Enter next test
or string number
```

For a 6 x 2 series parallel string with 1000 Ω damping resistor, 5m geophone interval and a 2.5 m lead in, the SMT-200 would be setup as shown. The Interval, Lead-in and Rcab must be specified. The geophone resistance test compensates for the additional resistance of the cable. If these three entries are incorrect the resistance test could fail as the SMT-200 will assume the extra resistance to be due to an abnormal coil or resistor.

NOTE: It is also convenient to load the new geophone specification from the PC Docking Station software. Please see section 3.

- 10. Select **0** to return to the **Setup menu**.
- 11. Select **3** to go to the **Operating menu**.

```

Operating menu
-----
1>Autonumber ON
2 Save Rej's YES
3 Full Test
4 Cont on reject
5 @Constant Exc.
6 T-Corr on Data
7 Continuous off
8 Interval 5 s

0 Back to Setup
-----
Enable automatic
test numbering
    
```

For general use the autonumber is normally on. Sensor recommends that distortion is tested at constant excursion and temperature correction is on data.

- 12. Select **0** to go back to the **Setup menu**.
- 13. Select **4** to select the **Tests Sequence menu**.

```

Tests Sequence
-----
1>Low Drive off
2 Polarity off
3 Noise off
4 Leakage off
5 Resistance ON
6 Fn, Bo, Go ON
7 Dist, Imp ON
8 Cont Imp off
9 Polarity First

0 Back to Setup
-----
Select
Low Drive Test
    
```

In general the tests which give the most useful information about the string are those selected **ON** as shown opposite.

- 14. Select **0** to return to the **Setup menu**.
- 15. Select **0** to go back to the **Main menu**.
- 16. Select **3** to go to the **Temp. menu**.

```

Temperature menu
-----
1>Temp 20.0 °C
2 Ref. Geo Temp.
3 Smartec ON
4 Smartec Temp.

0 Back to main
-----
Enter / display
string temp.
    
```

The setup shown here will work ok for most circumstances. If there is no geophone connector attached, selecting **4** will result in a message warning that no Smartec sensor was found.

- 17. Select **0** to return to the **Main menu**.



The string and test configuration is now setup. The remaining setup options refer to the way the SMT-200 operates and the default setting will operate okay. They can obviously be changed at any time to customise the unit for any particular user. The settings that have now been programmed will be used for any subsequent testing. However the new information has not been saved to the solid state memory at this stage. This will be done when the SMT-200 powers off or can be done manually by the **Save Config** option in the **File menu**.

5.2 Testing a string

To start testing a string:

1. If not already on, switch the SMT-200 on.
2. Select **Do a Test 1**

```
String config.
-----
[Sensor-SM4]
Temp [20.0 °C]
Series [1]
Parallel [1]
Not shunted
Next# [1 A]

Estimated space:
3276 Records

-----
0 Back to Main
- Repeat Test
Start next Test
```

This screen gives you a quick check that the parameters entered are correct before continuing.

3. Press **ENTER/START** to clear the Information screen and start the first test.

```
--Test results--
No. 1
Temp 20.0 °C
Pol 1
Leak 1401 Mohm
Res 382 ohm
Freq 9.91 Hz
Damp 0.259
Sens 28.7 V/m/s
Dist 0.04 %
Imp 2205 ohm
Test OK

-----
0 Back to Main
- Repeat Test
Start next Test
```

This is the result of the test that has just been run. The actual display will depend on tests selected in the test sequence menu.

4. If the test failed it can be re-run by pressing the +/- key.
5. If the test was ok connect the next geophone to be tested and hit the **ENTER/START** key.
6. Repeat steps 4 to 5 until all geophones have been tested.
7. Select **0** to return to the **Main menu**.

5.3 Downloading data to a PC

By this stage, if all has gone well there will be a sequence of records stored in the SMT-200 memory. These are quite safe and can only be erased by going into the file menu to erasing the data. More often that not the data will need to be downloaded to a PC and from there possibly to a spreadsheet. This is covered in detail in Section 4 but in brief :

1. Turn the SMT-200 off.
2. Connect the Docking Station to the SMT-200 and to the mains power supply.
3. Switch ON the Docking Station.
4. Leave the SMT-200 switched OFF.
5. Start the Docking Station program, C:\SMT200\SMT200DS.
6. Close the Opening Info window by pressing **Enter** (it times out after 10 s).
7. Select file transfer with **Alt-T**.
8. The SMT-200 will be powered-on and start the file exchange. The entire process could take a few moments so please wait for it to complete.
9. Once the exchange is successfully completed the program prompts you to 'Save DATA as'.
10. Select an appropriate name for the file (default is data001.prn).
11. The file is an ASCII text file with the fields separated by tabs. A typical example is shown below.
12. Should the transfer fail at stage 8 the best recovery action is to WAIT. The SMT-200 and the Docking Station will detect the failure and time-out. From this point the SMT-200 will turn itself off. Failure to do this may result in corrupted data or worse.

```
*****
Starting at 1997/04/17 12:36:21 NoNA
SMT-200 Geophone Tester Version 2.00 Serial nr. 2041
Spec Ser Par Shunt Mass Fdist VelDist Excur DataCorr Tests
Sensor-SM46 2 1000 11.0 12.00 0.700 0.0020 1 ABCI
Tested: Res Freq Damp Sens Dist Imp Pol RC Reject Temp Time
Min: 777 9.50 0.652 119.4 0.00 2143 -1 @20.0
Nom: 818 10.00 0.686 125.7 0.20 1
Max: 859 10.50 0.721 132.0 0.20 1
Num: ohm Hz V/m/s % ohm øC
1 793 9.90 0.706 167.2 0.19 2097 1 23 21.6 12:37:06
2 854 10.52 0.662 166.9 0.10 2260 1 23 21.6 12:37:21
3 842 9.80 0.667 161.7 0.08 2227 1 23 21.6 12:37:34
4 821 10.28 0.668 165.8 0.22 2171 1 23 21.6 12:37:47
5 788 10.31 0.707 170.8 0.06 2084 1 23 21.6 12:38:02
6 787 10.25 0.660 164.5 0.13 2081 1 23 21.6 12:38:15
7 804 9.84 0.710 167.2 0.12 2127 1 23 21.6 12:38:28
Ended at 1997/04/17 12:39:49
*****
```

13. This tab delimited file format is suitable for direct importation of data into most spreadsheet programs and data will be correctly import into adjacent columns.

The text file shown above is the result of a typical set of geophone tests. **RC** gives the reject code. Under the **Tests** heading the information **ABCI** shows the test that were run:



5.3.1 Data File Test codes

Code	Description
P	Low drive continuous impedance test
I	Polarity test
N	Noise test
M	Leakage test
A	Resistance test
B	Frequency, Damping and Sensitivity test
C	Distortion and Impedance test
K	Continuous Impedance (at Res. Freq.) test

5.3.2 Data File Reject codes

Code	Description
0	Reset
1	Resistance High
2	Resistance Low
3	Frequency High
4	Freq. far High
5	Frequency Low
6	Damping High
7	Gain High
8	Damping Low
9	Gain Low
10	Sensitivity High
11	Sensitivity Low
12	Distortion High
13	Dist. far High
14	Noise High
15	Freq. Tilt High
16	Freq. Tilt Low
17	Dist. Tilt High
18	Short Circuit
19	Open Circuit
20	Polarity Reversed
21	Test OK
22	Test OK
23	SIMULATION
24	Nop
25	Leakage
26	Leakage Overflow
27	Nop

5.4 Basic Geophone Troubleshooting using the continuous impedance test

It is recommended to first set aside defective strings and to fault find later. Once a defective string has been found the problem has to be further isolated. Most faults tend to be due to damaged cable. These are normally fairly easy to find. However some faults are more subtle. The best tool for finding these problems is the continuous impedance test.

For example say a particular geophone string failed the tests described in Section 5.2 with low sensitivity. This could indicate an out of spec element. To check for this set the test sequence menu as follows:

```

Tests Sequence
-----
1 Low Drive off
2 Polarity off
3 Noise off
4 Leakage off
5 Resistance off
6 Fn, Bo, Go off
7 Dist, Imp off
8>Cont Imp ON
9 Polarity Last

0 Back to Setup
-----
Select
Low Drive Test
    
```

This will activate the **continuous impedance** test when the next test is run. The bar-range will specify how sensitive the scale is and this can be set in the Limits menu [2-5-5].

- Invert all the geophones except for the first geophone in the string. The geophones are inverted to prevent movement of the coil. The bottom spring of a vertical phone is stronger than the top one to counteract the effect of gravity. By inverting the element or placing it on it's side the bottom spring clamps the coil to the top of the case. This will not work with horizontal phones or phones with a natural frequency above 14 Hz.

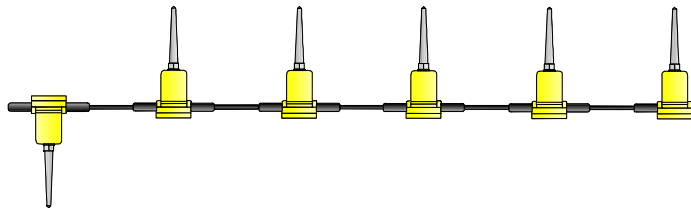

```

--Test results--
No.      10
Temp     24.2 °C
Imp      2112 ohm
<2069>   <2153>>

+/- New Ref
Now Testing
Cont Imp...
    
```

- Run the test. The first measurement will establish a reference impedance. (The actual value is not important it can take any range of values, there is no right or wrong value in this case).

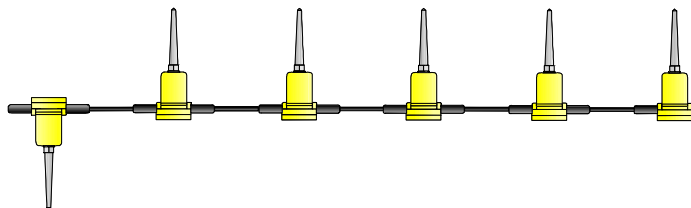



```
--Test results--
No.      10
Temp     24.2 °C
Imp      2104 ohm
<2069>   <2153>

+/- New Ref
Now Testing
Cont Imp....
```

- Next, invert each geophone one at a time and compare the measured impedance value. The aim is to look at relative changes,

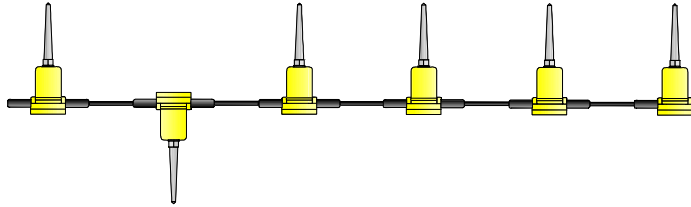

```
--Test results--
No.      10
Temp     24.2 °C
Imp      1724 ohm
<2069>   <2153>

+/- New Ref
Now Testing
Cont Imp....
```

- If there is one particular element that differs significantly from the rest then consider this one as suspect. If all subsequent elements read high or low then consider the first one as suspect. You may have used the **bad** geophone to establish a reference.

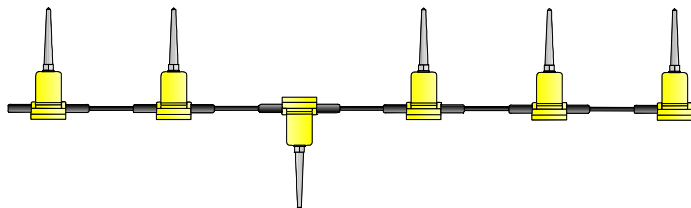

This is very effective with series strings. Series parallel strings are a little more difficult as the good branches tend to mask the bad one. In this case isolate the branch by laying down all the phones within a branch to locate the bad branch. From there, once the suspect branch has been isolated, proceed as above.

TIP: When running the continuous impedance for fault finding use the +/- key instead of the ENTER/START. Using the ENTER/START key will cause the result of the test to be logged to the internal memory. This technique can also be applied to regular tests as well.

```
--Test results--
No. 1
Temp 20.0 °C
Pol 1
Leak 1401 Mohm
Res 382 ohm
Freq *10.59 Hz
Damp *0.270
Sens *27.1 V/m/s
Dist 0.04 %
Imp 2205 ohm

Frequency High
-----
0 Back to Main
- Repeat Test
Start next Test
```

Frequency, Damping and Sensitivity Failures

If all of these parameters fail together then check for external noise (electrical or mechanical). Ensure the noise test is selected and check the noise level. These tests are grouped together as they are derived from the same test. Noise is also likely to result in increased distortion.

Failure of frequency, damping or sensitivity on a particular string is likely to be due to an element failure. The test procedure is similar to that just described except a test is run and processed each time.

```
--Test results--
No. 1
Temp 20.0 °C
Pol 1
Leak 1401 Mohm
Res *398 ohm
Freq 9.91 Hz
Damp 0.259
Sens 28.7 V/m/s
Dist 0.04 %
Imp 2205 ohm

Resistance High
-----
0 Back to Main
- Repeat Test
Start next Test
```

Resistance Failures

Resistance is directly related to temperature. If there is a continuous failure on resistance but sensitivity is ok then it is possible the temperature of the string is incorrectly set. Check the Smartec sensor is enabled and the SMT-200 Bendix connector (containing the sensor) is at a similar temperature to the string under test.

Check also the geophone interval and lead-in is correctly set.

```
--Test results--
No. 1
Temp 20.0 °C
Pol 1
Leak 1401 Mohm
Res 382 ohm
Freq 9.91 Hz
Damp 0.259
Sens 28.7 V/m/s
Dist *0.22 %
Imp 2205 ohm

Distortion High
-----
0 Back to Main
- Repeat Test
Start next Test
```

Distortion Failures

Check the noise level is not excessive. Troubleshooting procedure is the same as for continuous impedance. Check all geophones are securely planted and are planted upright. A common cause for distortion failures is the coil impacting the case end plate if there is an excessive tilt on the phones. The manufacturers specification sheet will state the maximum angle of tilt that is allowable.

If the elements natural frequency is less than 12 Hz then it is advisable to run the test at constant excursion. For these phones the test may fail if the distortion tests are run at the natural frequency without compensation.



```

--Test results--
No. 1
Temp 20.0 °C
Pol 1
Leak 1401 Mohm
Res 382 ohm
Freq 9.91 Hz
Damp 0.259
Sens 28.7 V/m/s
Dist 0.04 %
Imp *1998 ohm

-----
0 Back to Main
- Repeat Test
Start next Test

```

Impedance Failures

Impedance failures could be a result excessive tilt of geophones for the same reason as distortion failures. Elements that are sticking are likely to produce a lower impedance reading. If there is not an obvious problem use the continuous impedance test to further isolate the problem.

5.5 Isolation Table

From the above it will hopefully become clear that external noise and vibration can seriously effect the test results. To minimise the effect of external noise an isolation table can be constructed. The geophones can then be placed on this for testing. An example of a simple isolation table is shown below.

Cases with spikes require holes to be drilled in the top

Heavy piece of wood (Railway Sleeper size)



Car Inner-Tube

Page intentionally left blank



Section 6

SMT-200 Technical

Page intentionally left blank

6.1 SMT-200 Description

The SMT-200 consists of two main parts. The heart of the unit is the PC/104 single board computer. This board features a CMOS 8088 - compatible CPU operating at 9.8 MHz. This achieves a good balance between performance and excessive power consumption / heat generation inherent in faster processors. The other part is the SMT-200 main board. This has all the additional circuitry required to generate test signals and transfer digitised data to the PC/104.

6.2 PC/104 Description

The PC/104 runs the SMT-200 software from the onboard Solid State Disk (SSD). New code can be downloaded to the SSD via a PC connected to the Docking Station. The PC/104 board is highly integrated and repairs to the card are not advised. If the card is in doubt the entire SMT-200 should be returned to the nearest I/O SENSOR service location for repair.

PC/104 Board Features

- 8088 Compatible CPU running at 9.8 MHz
- 1Mb DRAM
- 3 DMA channels - 8237 equivalent
- 8 Interrupt channels - 8259 equivalent
- 3 programmable counters/timers - 8254 equivalent
- PC - compatible keyboard port
- 8 bit PC/104 expansion bus
- Speaker Port
- Award ROM-BIOS with Ampro embedded-PC extensions
- Real time clock
- Parallel port - bi-directional data lines
- Serial port - onboard generation of $\pm 9V$
- 32 pin byte wide memory DIP socket
- 1K bit configuration EEPROM
- Watchdog timer

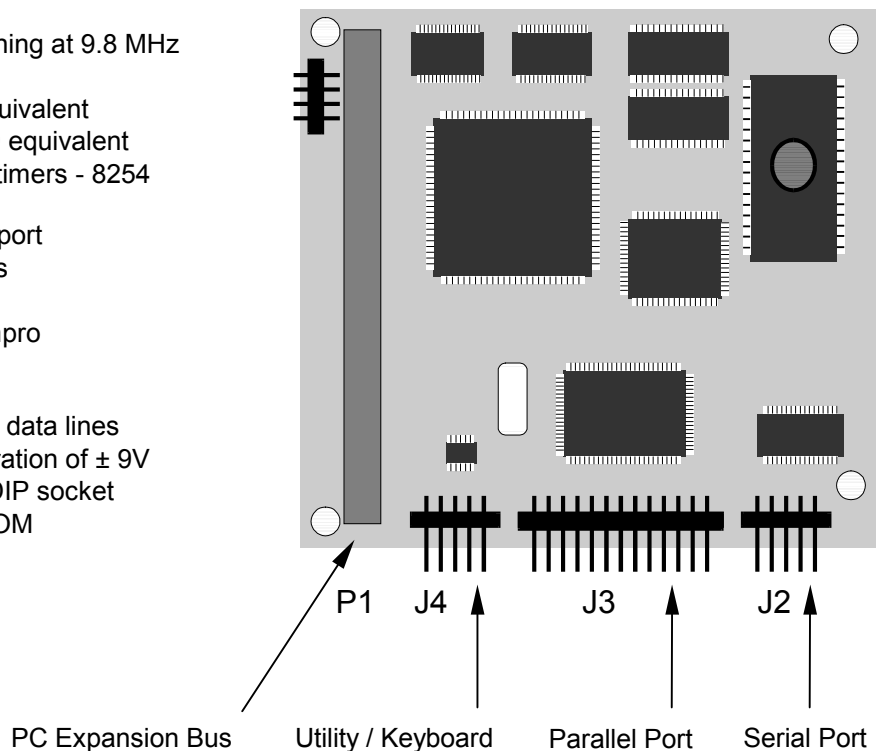

Mechanical and Environmental

- | | |
|-------------------------|-----------------|
| • Size | 90 x 96 x 15 mm |
| • Power Active | +5v @ 115 mA |
| • Power Sleep | +5V @ 55 mA |
| • Operating Temperature | -40°C to +85°C |
| • Storage Temperature | -55°C to +85°C |
| • Relative Humidity | 5% to 95% |
| • Weight | 67 gm |

6.3 PC/104 Connector and Jumper Locations

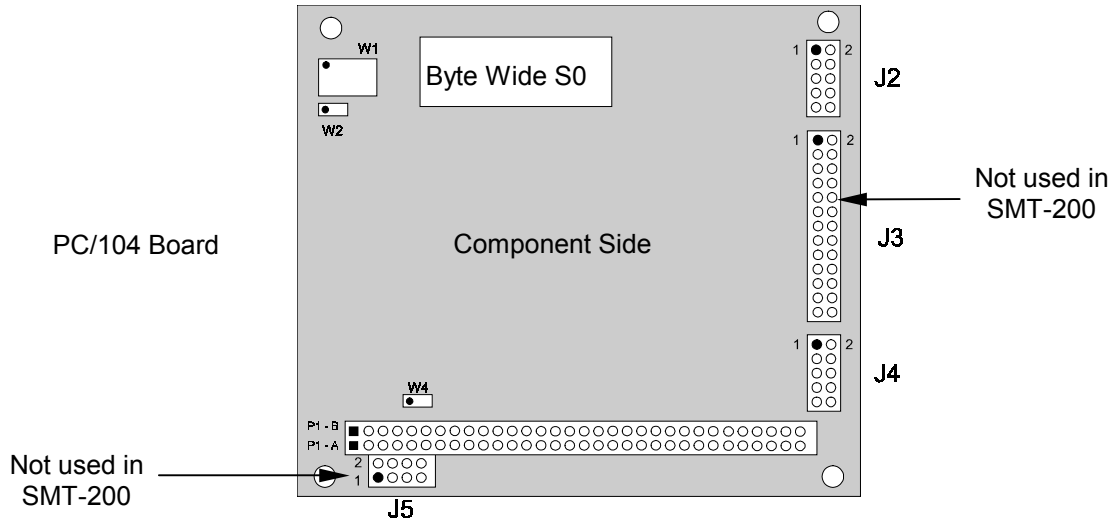

Pin	Name	Pin	Name
A1	-IO CHCHK	B1	GND
A2	SD7	B2	RESET
A3	SD6	B3	+5V
A4	SD5	B4	IRQ2
A5	SD4	B5	-5V
A6	SD3	B6	DRQ2
A7	SD2	B7	-12V
A8	SD1	B8	N/A
A9	SD0	B9	+12V
A10	I/O CRDY	B10	N/A
A11	AEN	B11	-SMEMW
A12	SA19	B12	-SMEMR
A13	SA18	B13	-IOW
A14	SA17	B14	-IOR
A15	SA16	B15	-DACK3
A16	SA15	B16	DRQ3
A17	SA14	B17	-DACK1
A18	SA13	B18	DRQ1
A19	SA12	B19	-REFRESH
A20	SA11	B20	CLK
A21	SA10	B21	IRQ7
A22	SA9	B22	IRQ6
A23	SA8	B23	IRQ5
A24	SA7	B24	IRQ4
A25	SA6	B25	IRQ3
A26	SA5	B26	-DACK2
A27	SA4	B27	T/C
A28	SA3	B28	BALE
A29	SA2	B29	+5V
A30	SA1	B30	OSC
A31	SA0	B31	GND
A32	GND	B32	GND

PC-104 Bus Connector

Pin	Name
1	DCD
2	DSR
3	RXD
4	RTS
5	TXD
6	CTS
7	DTR
8	RI
9	GND
10	Key Pin

Serial Port Connector (J2)

Pin	Name
1	Speaker +
2	-Bat
3	Reset Switch
4	N/C
5	Kbd Data
6	Kbd Clk
7	Kbd Gnd
8	Kbd Pwr
9	+Bat
10	Power Good

Utility Connector (J4)

- W1 - Byte-wide (S0) configuration
- W2 - Byte-wide (S0) configuration
- W4 - 12V flash programming power

6.4 SMT-200 Main Board block diagram

This section contains a functional description of the SMT-200 main board. The board contains all the required circuitry to generate the test signals for the geophones and digitise the signals via the A-D converter. In addition the board has the keypad and LCD display drivers and also the power supply circuit.

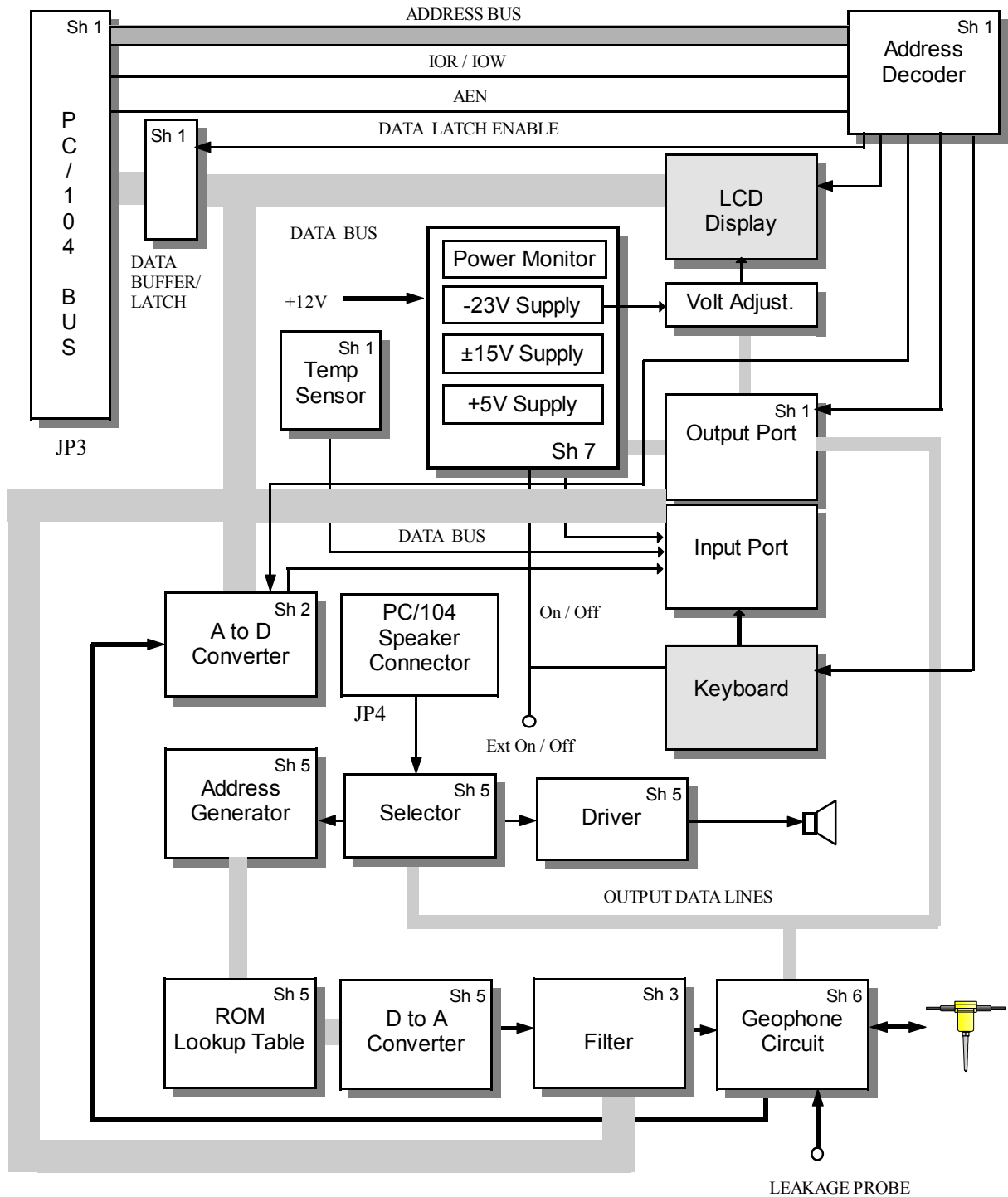

6.5 Power Supply

The main power supply is shown on sheet 7. of the SMT-200 Schematic.

The 12 V from the battery is fed to U19 and U20, which are ± 15 V and 5 V regulators respectively. The ± 15 V is used for the analogue circuitry and is switched on or off via O11, pin 19 of the Program Peripheral Interface (PPI) chip. The PPI is configured to give 8 input and 16 output lines. The 5 V circuit can be shutdown via O10 which will reset the RS flip-flop built around U22. The signal - ON/OFF is used to switch the unit on. The signal is normally held high by R32. When the ENTER/START button is pressed on the front panel this signal will be forced low and will cause the output of the flip-flop to be latched low. This will turn U20 and thus the 5 v on. The ENTER/START button will go high once it is released. The state of this line is monitored by I3, pin 2 on the PPI for use in the keyboard circuit. When connected to the docking station a PC can also turn on the SMT-200 via the mosfet switch connected to the DTR line.

The circuit to generate the LCD contrast voltage is built around U24, TL497 switching regulator. It is configured to provide -23 v which is then fed to a variable gain amplifier. The gain is set to less than unity and can be adjusted via O12 to O15 of the PPI.

The battery voltage is continually monitored by a voltage detector, U21. The output pin (4) of this device is an open collector transistor which will turn on when the voltage on the threshold pin (3) drops below 1.15 V. With the values of R37 and R38 selected the signal -LOBATT will go low when the voltage is less than 10.7 V.

6.6 Address Decoder

The address decoder shown on sheet 7. of the SMT-200 Schematic.

The SMT-200 hardware is mapped into the PC I/O locations by U1, U3 and U4. The output of U4 (pin 8) is low when there is an I/O read or write to a valid (1B0h to 1BFh) location. This is further decoded by U1 to generate the enable signals for the various devices.

Data on the PC's bus is latched into U2 when U4, pin 8 becomes active and a I/O write (IOW) is issued and latched from the various devices when U4, pin 8 and a I/O read (IOR) is issued.

6.7 Display

The LCD interface is on sheet 7. of the SMT-200 Schematic.

The LCD display connects to JP8. The display module connects more or less directly to the PC bus. The backlight is switched on or off via Q6 (BS170 Mosfet) controlled by O9 of the PPI. The contrast of the display is very dependant on the temperature. Temperature is monitored by the internal Smartec sensor and used to update the contrast using the circuit described in section 5.1.

6.8 Keyboard

The keyboard circuit is shown on sheet 7 of the SMT-200 Schematic.

The keyboard is a 4 x 4 membrane keypad with an additional switch for the ENTER/START key. This feeds a 16 key encoder IC based on U9. This IC will scan the keyboard matrix at a rate determined by the capacitor on pin 5. When a key is pressed the key is debounced (the debounce period is set by value C10 on pin 6) and the DAV line (pin 12) is asserted. This is polled and read on I4, pin 44 of the PPI. The data on pins 14 to 16 at this stage is stable and can be read directly by the PC. The data is a 4 bit code that represents the key pressed.

The **ENTER/START** key is active low and does not go through the encoder but is fed directly to the PPI.

6.9 Digital to Analogue Converter

The digital to analogue converter circuit is shown on sheet 7 of the SMT-200 Schematic.

The digital to analogue converter (DAC) is formed around a lookup table stored in the EPROM, U12. This contains the digital values for a low distortion sine wave. The clock for each sample starts at the PC speaker. The PC speaker frequency can be altered by the software. The output that would normally be fed to the speaker is firstly buffered by Q2 and sent to an address generator (U10) and a selector (U15). The address generator is a 12 stage binary counter clocked by Q2. The incrementing address is fed to the EPROM that generates the data samples. This is then fed to the DAC which converts the sample to an analogue signal.

The selector U15, selects the function of the PC speaker. It has a three functions :

- Address Generator Clock
- A to D Converter convert signal
- Audio Speaker

The signal that appears on 1Y of U15 is selected from one of the inputs on 1C0, 1C1, 1C2 and 1C3 and similarly the signal on 2Y is selected from 2C0, 2C1, 2C2 or 2C3. The particular output is set by the 2 digit code on lines A and B of U15.

B (O1)	A(O0)	1Y (CONVERT)	2Y (SP+ SP-)
0	0	Note 1	0 v
0	1	PC-SP	0 v
1	0	VCC	PC-SP
1	1	0 v	PC-SP

Note 1
Pulsed low every 32
clock cycles of PC-SP

6.10 Filter

The filter circuit is shown on sheet 3. of the SMT-200 Schematic.

Once the analogue signal has left the D to A converter it passes through a buffer (U8A) and to a high pass filter. After this it passes directly to an attenuator. The amount of attenuation is set by the data word set on D0 to D7. From here the signal passes to the geophone circuit.

6.11 Geophone Circuit

The geophone circuit is shown on sheet 6. of the SMT-200 Schematic.

The signal from the filter is buffered (U17B) and passed to an amplifier circuit. The geophone under test is in the feedback path of the amplifier, so the output of the circuit is dependant on the geophone. As a reference a high precision, 499 W resistor can be substituted for the geophone. This is selected by the O2 (pin 22) of the PPI. O2 switches relay K1 via the mosfet Q3. Using a method of comparison with the reference resistor (R30) the effects of temperature drifts and offsets can be minimised.

The output of the driven geophone is fed to a programmable gain amplifier based on U17C and U16. The feedback resistor of the amplifier is selected by the code on O3 to O5. U16 is a programmable switch that will select R19 to R26.

The output of the programmable amplifier is fed to a selector, U18. This device has two 4 to 1 encoders whose outputs are selected by the code on the A0 (pin 16) and A1 (pin 1). The control signal for these originate on O6 and O7 of the PPI.

A1	A0	1-4	5-8
0	0	Geophone	Not used
0	1	Leakage	x 100 or Battery monitor option
1	0	Leakage	x 1000
1	1	Leakage	x 10000

In the case of geophone data the data passes straight through the selector. If leakage is selected the gain applied is dependant on the code on A0 and A1.

The leakage circuit works applying a DC signal to the geophone and amplifying any signal picked up on the leakage terminal (LEAK). The signal that appears on the LEAK terminal is assumed to have originated from the geophone and only appears due to leakage of the string. Two (or three) gain settings are selected automatically as shown in the above table. (see also page 32)

6.12 Analogue to Digital Converter

The A to D circuit is shown on sheet 2. of the SMT-200 Schematic.

The A to D is based on U6. This is a CMOS based 16-Bit sampling A to D converter using a successive approximation technique. This chip has the advantage of having a built in sample and hold circuit and can digitise a signal within 25µS.

The signal to be digitised appears on the R11N pin via R2. The conversion process is started by the R/-C input being forced low. Shortly after this -BUSY will go low to indicate that a conversion is in process. The CPU can monitor this via PA0 of the 8255 PPI. Once conversion has been completed

(signaled by -BUSY going high), the data is available on the parallel outputs. The data bus size is 8 bits so the 16 bit word is read in 2 parts, high byte and low byte. The particular byte to read is determined by A0 which is connected to the BYTE input. PB1 of the PPI can be used to switch the analogue circuit within the chip of to conserve power when not in use.

6.13 SMT-200 Interconnection

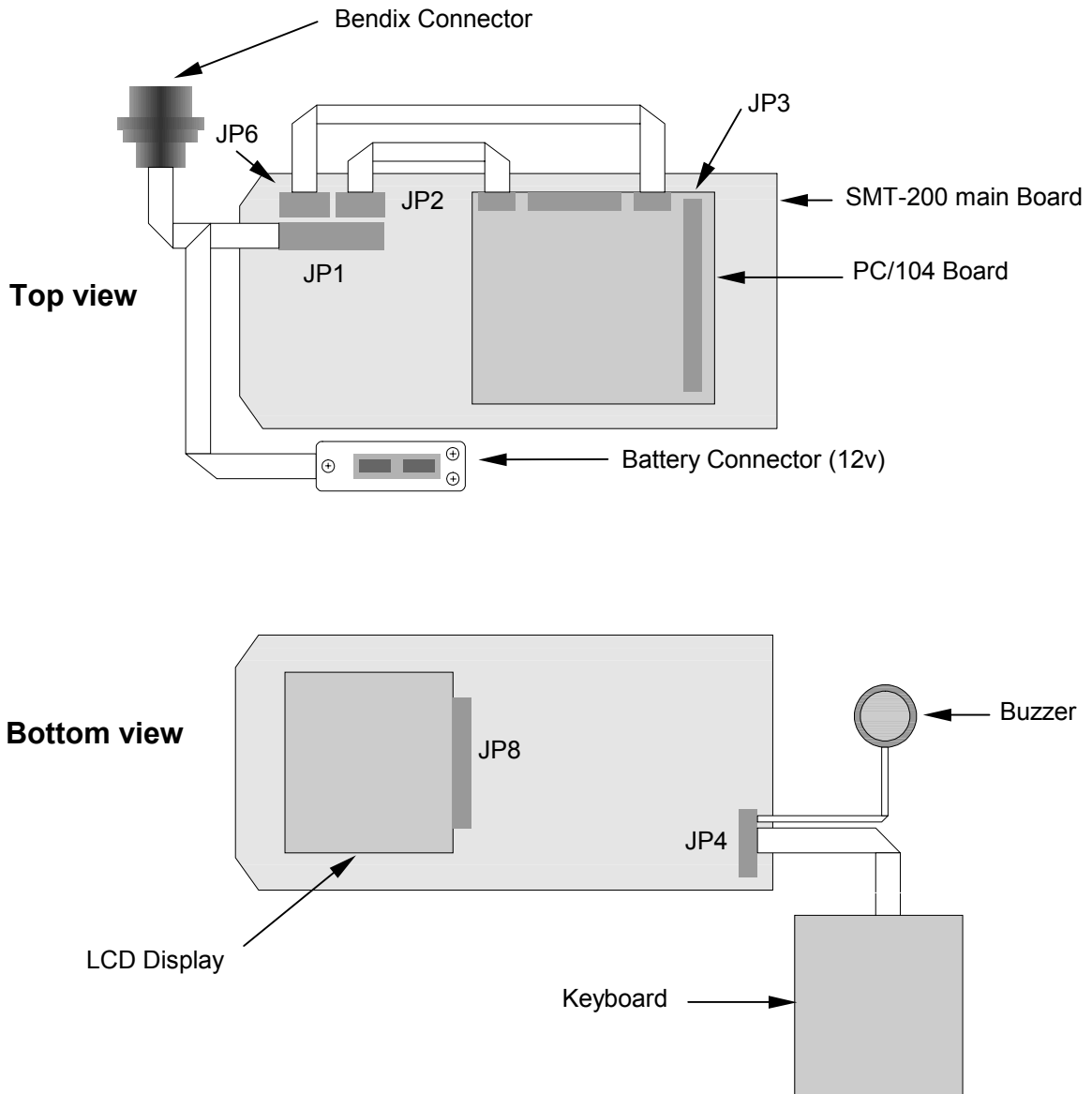

Note: The power connector (J5) on the PC/104 board is not used. Power for the this board is derived from the 5 V regulator on the main board and fed to the PC/104 via JP3.

Page intentionally left blank



Section 7

Docking Station

Technical

Page intentionally left blank

7.1 Docking Station Block Diagram

The docking station has two major functions:

- PC Interface
- Battery Charging

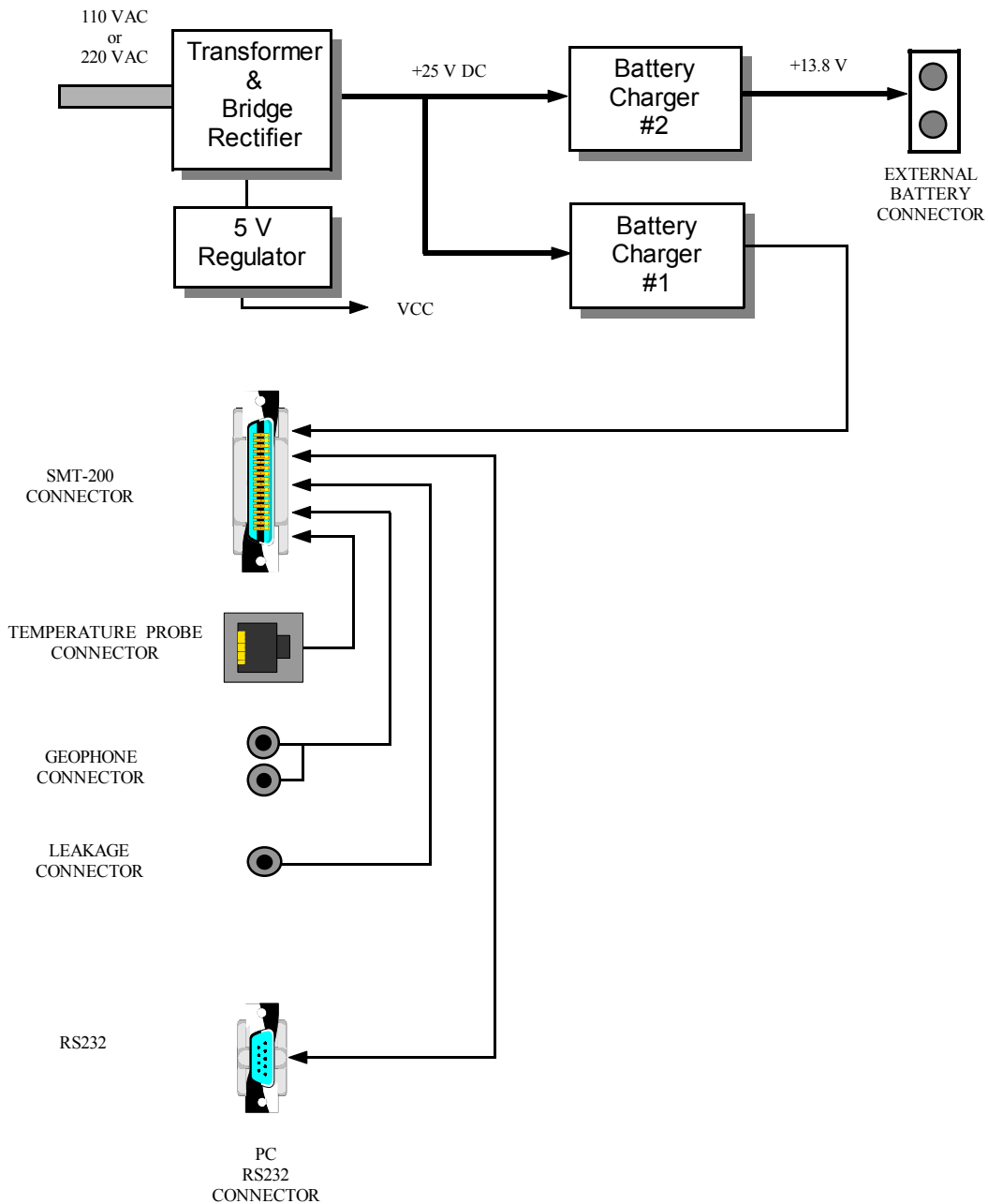

7.2 PC Interface

The SMT-200 is connected to the docking stations Centronics 24 way connector (J1) . The geophone sockets on the docking station, the Smartec RJ-11 (JP3) and the output of battery charger #1 connect directly to J1. The PC's handshake signals also connect directly to J1.

The Data Terminal Ready (DTR) line has a secondary function. When active it will switch the SMT-200 on. When DTR is asserted the mosfet Q1 will conduct and toggle the power on flip flop in the SMT-200.

7.3 Battery Charging

There are two totally independent charging circuits built around U6 and U7. These devices are UC3906 sealed lead acid battery charger IC's. These controllers contain the necessary circuitry to optimally charge sealed lead acid batteries. These type of batteries have specific charging requirements so the SMT-200 batteries should only be charged on the docking station.

There are four basic states the charging circuit will assume (see table below).

STATE	DESCRIPTION	LED COLOUR
1 Low Current Turn on	Very small current. Checks for dead or disconnected battery.	off
2 Bulk Charge	High current to minimise charging time.	RED
3 Controlled Overcharge	Battery V and I monitored to prevent overcharging	ORANGE
4 Precision Float Charge	Trickle charge (same as State 1)	GREEN

The dual colour LED has a green and red LED. If both are on at the same time the LED will appear orange in colour.

The two charging circuits are similar. Battery charger #1 has some additional circuitry that compensates for the extra current the SMT-200 draws when connected to the charger.

Looking at Charging Circuit #2, when the battery is first connected it starts to charge by the current flowing through R23. If the battery is shorted this will limit the current to a safe level. Once this current has caused the battery voltage to increase above a preset threshold the charger will switch to State 2 (Bulk Charge) and continue to charge the battery until the battery voltage rises to 95 % of the Over Charge voltage. At this point the charger will switch to State 3, the Controlled Overcharge state. During State 2 and State 3 the Over Charge Terminate pin of U7 (pin 8) is low turning on Q7 and the red LED. It will continue charging until the current drops to 10% of the maximum current supplied during State 2 (about 500 mA). At this point the charger will assume State 4 (the trickle charge state) where the battery is floated via the current flowing through R23. Pin 8 of U7 will now turn the red LED off.

The green LED is turned on via Q9 and Q8. The transistor Q8 is will turn the LED on (via Q9) when sufficient current flows through D6 providing pin 10 of U7 is high. If pin 10 is low (as it is during State 1 and 2) Q8 will not conduct regardless if Q11 is on or off preventing the green LED from illuminating.

The Charger #1 (SMT-200) is very similar with the addition of a relay. Relay K1 will energise when the SMT-200 is switched on, adding R16 into the circuit. The effect of this to the change the point the



circuit switches from State 3 to State 4 from 10% to 50%. This allows for the extra current drawn by the SMT-200 when it's on.

Page intentionally left blank



Appendix A

Connector Pin outs

Page intentionally left blank

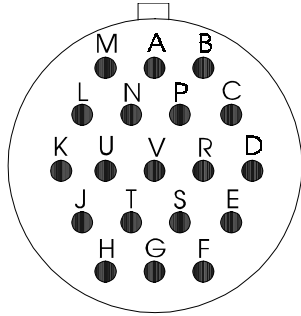
A.1 SMT-200 Bendix Connector

(viewed into the male connector)

PIN	NAME
A	Charger V+
B	Charger V-
C	Geophone -
D	Geophone +
E	Geophone Leak
F	Geophone Shield
G	Smartec EXT
H	Smartec V+
J	Smartec GND
K	ON/OFF
L	DCD
M	DSR
N	RXD
P	RTS
R	TXD
S	CTS
T	DTR
U	RI
V	SG

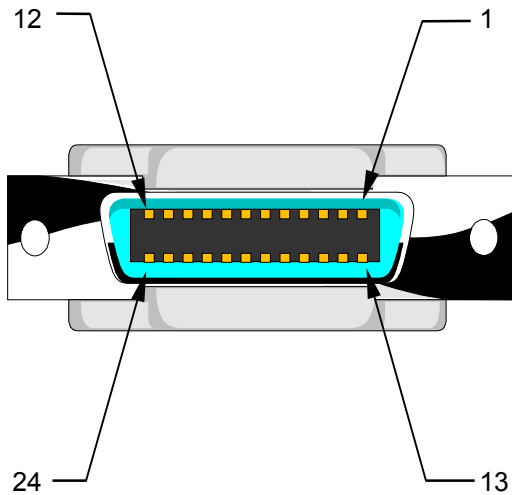
A.2 Docking Station SMT-200 Connector

(view from rear of Docking Station)

PIN	NAME
1	Charger V+
2	Charger V-
3	Shield
4	Geophone -
5	Geophone Leak
6	Smartec EXT
7	Smartec GND
8	Shield
9	DSR
10	(nc)
11	CTS
12	RI
13	Charger V+
14	Charger V-
15	(nc)
16	Geophone +
17	Geophone Shield
18	Smartec V+
19	ON/OFF
20	DCD
21	RXD
22	TXD
23	DTR
24	SG

A.3 Docking Station External Smartec Connector

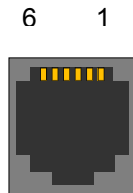

(view from rear of Docking Station)

PIN	NAME
1	(nc)
2	Smartec EXT
3	Smartec V+
4	Smartec GND
5	(nc)
6	(nc)

A.4 Docking Station PC Connector

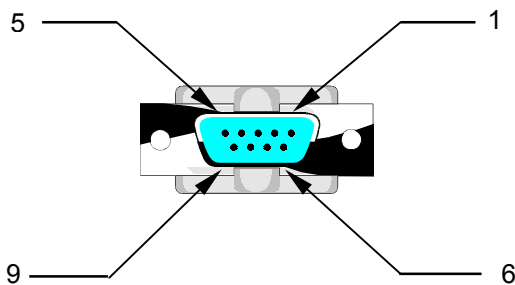

(view from rear of Docking Station)

PIN	NAME
1	DCD
2	RXD
3	TXD
4	DTR
5	SG
6	DSR
7	RTS
8	CTS
9	RI

A.5 Smartec Temperature Sensor

The Smartec temperature sensor is a solid state device that can be fed directly to an input line of a microcontroller without the need for A-D conversion circuitry. Operating from a 5 V supply it provides a duty modulated square wave on a single terminal. By averaging the output and comparing the time spent at both high and low logic levels an accurate figure for the temperature can be found.

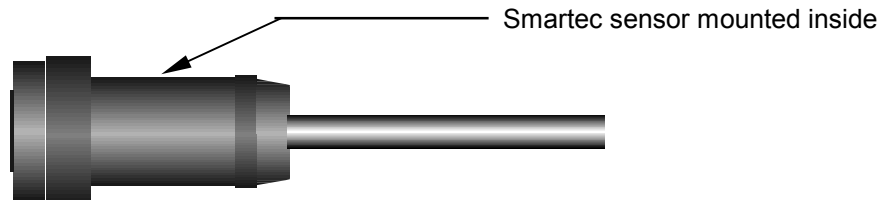

There are two Smartec temperature sensors that can be used for string temperature. The first is located inside the Bendix geophone cable connector. The Bendix geophone connector is not used with the docking station so in this case the external Smartec sensor is used. This plugs into the rear of the Docking Station via the RJ-11 connector.

The Smartec temperature sensor is there to measure the *string temperature*. For the Smartec to correctly measure the string temperature there should not be a large temperature differential between the SMT-200 and the string being tested. In cases where there is a large difference, such as testing inside a building when the strings are outside, it is advisable that the Smartec should be taken out of the Bendix and mounted on a flying lead. The sensor can then be left close to the string under test to give an accurate indication of string temperature.

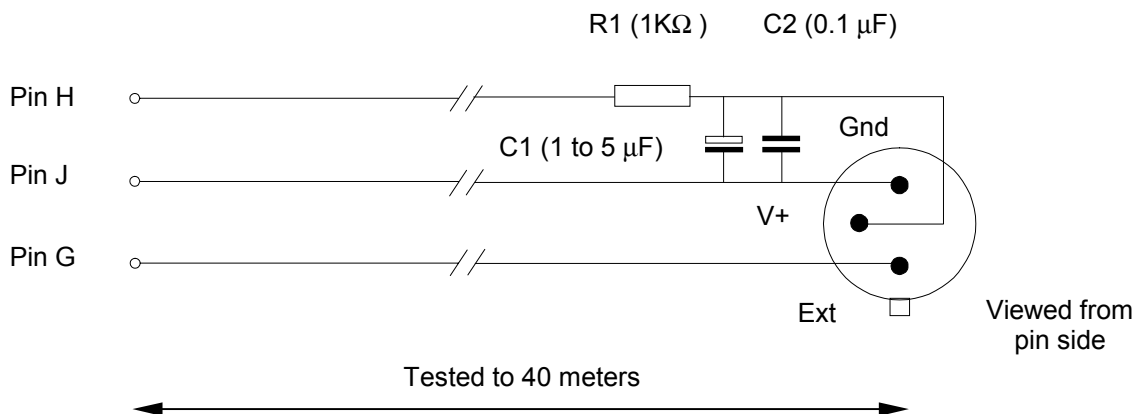

If the temperature readings become unstable after the Smartec is mounted on the flying lead there could be noise being picked up on the lead. If this is the case a simple filter circuit, as shown above, should eliminate any pickup.

A.6 SMT-200 to Docking Station Cable

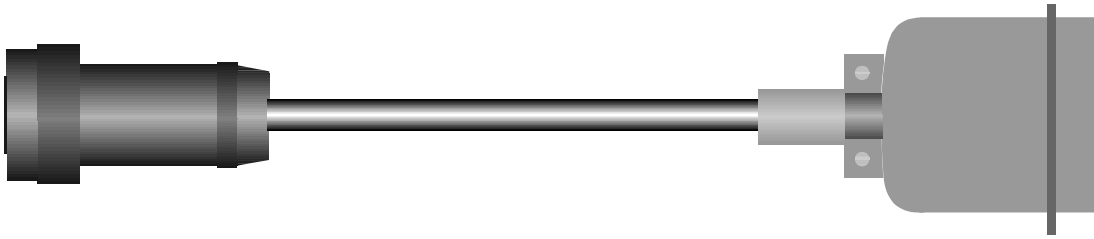

Bendix Connector

Centronix Connector

Bendix Pin	Centronics Pin	Signal Name	SMT-200 PCB connect	Wire Colour
A	1	Charger V+	1	Red
A	13	Charger V+	2	Purple
B	2	Charger V+	3	Black
B	14	Charger V+	4	Blue
-	-	Battery V+	5	-
-	-	Battery V+	6	-
-	-	Battery V-	7	-
-	-	Battery V-	8	-
C	4	Geo -	9	Grey
D	16	Geo +	10	Pink
E	5	Geo LK	11	Yellow
F	17	Geo SHL	12	Green
G	6	Smartec EXT	13	White/Yellow
H	18	Smartec V+	14	White/Red
J	7	Smartec GND	15	White/Black
K	19	ON / OFF	16	Red/Blue
-	8 & 3	Shield (Case)	17	Shield
L	20	DCD	18	Grey/Green
M	9	DSR	19	Grey/Pink
N	21	RXD	20	Brown/Blue
P	10	RTS	21	Brown/Yellow
R	22	TXD	22	Brown/Red
S	11	CTS	23	Brown/Pink
T	23	DTR	24	Brown/Green
U	12	RI	25	Brown/Black
V	24	SG	26	Brown/Grey
-	-	(unused)	-	Brown
-	-	(unused)	-	White
-	-	(unused)	-	White/Grey
-	-	(unused)	-	White/Pink
-	-	(unused)	-	White/Green
-	-	(unused)	-	White/Blue

Appendix B

Test Overview

Page intentionally left blank

B.1 Geophone Basics

In its simplest form a geophone element consists of a coil of wire wound on a former and mounted on springs. The basic idea is that inertia will, in principle, keep the coil fixed in space while a magnet firmly attached to the case moves around it (above natural frequency). When a conductor breaks the magnetic flux lines produced by the magnet a current is generated. A current flowing through any form of resistance will produce a voltage across the resistance. In our case this voltage is fed to the input stages of a recording system. The current produced by a single conductor is fairly small so a large number of turns are used to increase the current produced.

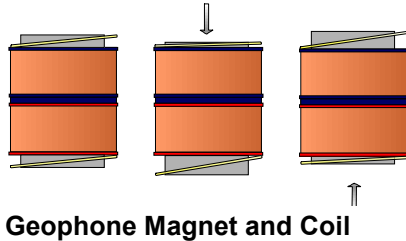

The voltage that the geophone produces is proportional to the velocity of the ground it is coupled to (above natural frequency). Just as we need to perform instrument tests on recording systems we need to perform tests on the geophones. This ensures the signal that we record on tape is an accurate representation of the ground response to an energy release. The SMT-200 tests have been carefully designed to perform this function.

The fundamental principle the SMT-200 uses for its tests is the idea that conductors breaking magnetic flux lines producing a current can be applied in reverse. The SMT-200 can apply current to a phone under test which will physically move the coil. This movement will indirectly produce a voltage we can measure.

The following is a description of the tests that the SMT-200 can perform and why each is necessary.

B.2 Polarity Test

It is very important that all strings have the same polarity. That is a similar movement applied to each detector, at the same time, produces a current in the same direction in each and every detector. Phone reversal means a typical string will have an element that is canceling out instead of adding to the signal being fed to the recording system (one reversed element will reduce the string sensitivity by two elements). The effect is worse when strings are reversed.

This causes more severe problems with parallel string arrangements and CDP stacking problems in single string arrays. Reversed strings cannot be detected by the recording systems geophone pulse test so it is important that this test is performed on all strings.

TEST PRINCIPLE.....

The SMT-200 monitors the output of the geophone. Once it goes above a predetermined level for a certain amount of time the SMT-200 will decide that it is a "first break" of and external source (normally a tap) and generate a different audio signal depending on the polarity.

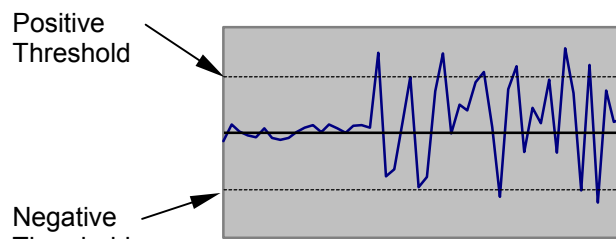

Polarity test Thresholds

NOTE: The SEG standard for geophones states that the upward motion of the geophone case should produce negative numbers on tape. This normally means geophones are wired so that an upward motion of the case will result in a negative going signal. This is a recommendation only and every geophysicist is obviously free to choose SEG or Non-SEG polarity

B.3 Noise Test

The SMT-200 assumes that there are no other signals that are influencing the geophone under test. If other signals are acting upon the geophone then these signals will be added to the test signal being applied and the unit will incorrectly identify this as an error signal generated by the phone. To avoid this situation the ambient noise can be monitored. There are two types of noise that can disturb the SMT-200 readings.

Mechanical Noise This can be random or periodic noise produced by objects such as trucks passing near the phone under test or generators running nearby. The geophone is physically moving to produce an error signal. To avoid this run the tests away from heavy machinery and avoid people walking near the geophone while the unit is collecting data.

Electrical Noise Can be less obvious to detect. The error signal is being induced into the leads that make up the test system even though there is no physical connection between the two. This process is known as induction and is the principle transformers use. Normally this is caused by running tests under or over high voltage power lines. If there is no obvious reason for tests failing suspect induced noise, possibly from underground power lines.

TEST PRINCIPLE.....

The SMT-200 monitors the output of the geophone for 800 samples over 96 ms, the average level of noise is then computed. The lower the noise value the better. In practice (depending on the geophone string configuration) a result of less than 30mV ambient noise picked up will not effect the results.

B.4 Leakage Test

In the perfect geophone string, the current flowing out of one terminal of the string is exactly equal to the current flowing into the other terminal of the string. If there is another path the current can take then this is known as leakage.

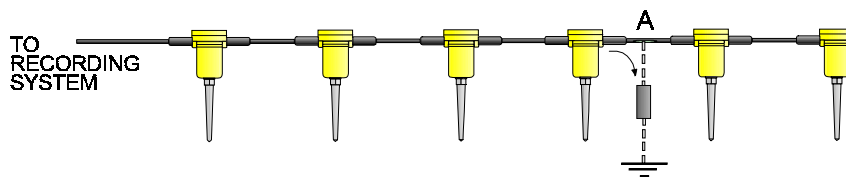

Leakage path due to damaged leader cable

The figure above shows the current has found another path, in this case to ground. The main problem here is the effect it has on the recording systems input stages. Most modern recording systems have differential inputs. That means any signal common to both wires will not be seen on the output of the preamplifier. This is known as common mode rejection. This will only work if the current into and out of the preamp are equal and balanced. A typical example is 50 Hz mains pickup. If there is a current imbalance some of the 50 Hz common mode signal will be converted to a differential mode signal and appear on the output of the preamplifier. This is typically seen when the geophone strings protective jacket has been damaged and the string is used in water.

TEST PRINCIPLE.....

A DC voltage (5-10V) is applied between the geophone negative terminal and an external probe connected to the leakage terminal. The current flowing between the geophone terminals and the leakage probe is amplified and compared with the current flowing in an internal reference resistor. The ratio of the two readings gives a value for the leakage of the geophone string.

B.5 Resistance Test

This is a DC resistance test of the coil, shunt and leader resistance. It quickly determines if the string has open coils or shunt resistors. It also confirms the correct series / parallel combination of geophones are connected. Most recording systems use this as the basic geophone QC test.

TEST PRINCIPLE.....

The same procedure for the leakage test is used except the readings are taken between the two geophone terminals.

B.6 Pulse Test

This single test provides a wealth of information about a geophone. From this test we can determine three parameters: Natural Frequency (F_n), Damping (B_o or B_t) and Sensitivity (G_o).

Fig.4 shows the geophone response (in the time domain) to an impulse. The oscillations will reduce to zero. The rate at which this will happen is determined by the damping. The time to the first zero crossing is dependant on the natural frequency of the phone.

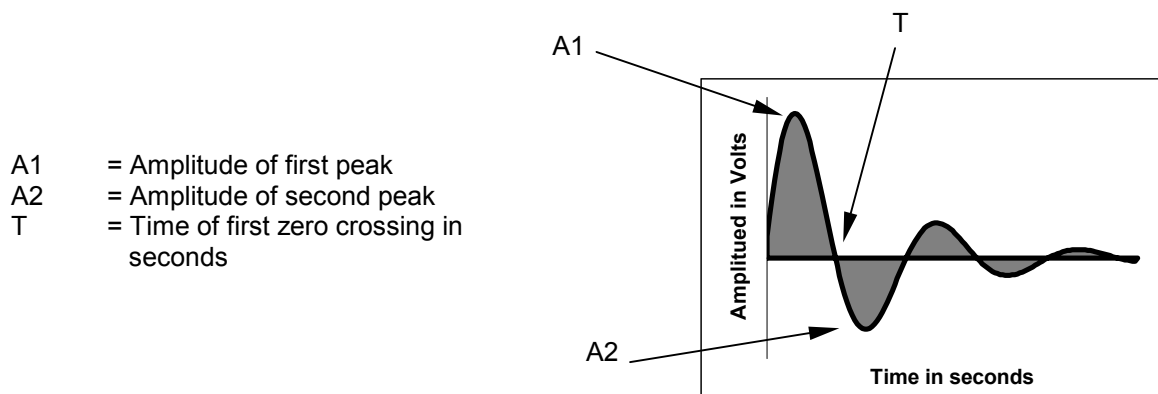

Geophone Pulse response

Natural Frequency

This is the frequency that the geophone coil will naturally oscillate at when freely suspended. The actual frequency depends primarily on the stiffness of the spring and the suspended mass. A geophone having a natural frequency of say 10 Hz means that any signal at that frequency will tend to be boosted. An undamped phone will not to have a flat response over the seismic frequency band and sometimes high amplitude low frequency energy such as ground roll can swamp higher frequency data unless it is controlled. The normal way of doing this is a process know as damping.

Energy hitting the phone perpendicular to its normal direction of travel can cause unwanted oscillations in the springs, which in turn causes a spurious frequency. This is specific to each geophone type but tends to be at relatively high frequencies and normally above 150 Hz.

Damping

Damping tends to reduce oscillation at the phones natural frequency. This is achieved by adding an external resistor across the terminals of the phone. In this case large excursions that occur at the geophone natural frequency are now opposed by the current flowing in the resistor giving rise to a “motor action” . This gives a more uniform response curve. Open circuit damping B_0 (intrinsic damping) is the damping with no external damping resistor.

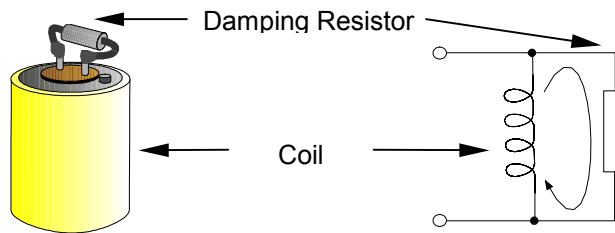

Damping resistor electrical configuration

Sensitivity

Measured in V/m/s (i.e. Volts per meter/second) this gives an indication of the magnitude of the output voltage in response to a certain velocity applied to a phone. Sometimes known as transduction. Sensitivity depends on the load the geophone is driving. Shunt resistors have an effect on the sensitivity of the geophone and so does the recording systems input stages. The seismic detector response curves shown in the Sensor geophone specification sheets show the open circuit (OC) damping sensitivity curve at the top and the damping curve with various values of shunt resistors underneath. See figure below.

**GEOPHONE RESPONSE CURVE
SM-4 model B 10 Hz**

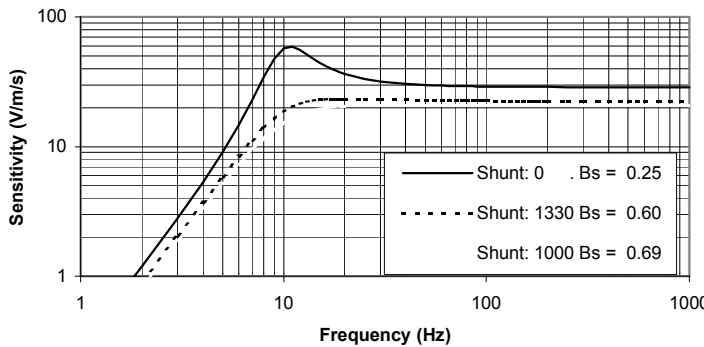

Geophone response curves

present information in the frequency domain. The x axis shows the frequency on a logarithmic scale. The y axis shows the geophone sensitivity on a logarithmic scale. This gives a clear indication of the geophone response over the full range of seismic frequencies.

TEST PRINCIPLE.....

As its name implies the pulse test applies a short pulse to the coil of the geophone. The current used to do this is calculated (using the stored geophone parameters) to normally give a 70% excursion from its rest position. When the current is turned off the coil will drop and the result is a sinusoid that decays exponentially.



Damping (Bt) is calculated by comparing the first and second peak. High damping means the magnitude of the second peak will be much less than the first. No other variables are needed to determine damping.

$$Bt = \text{Sin} \left[\arctan \left(\frac{In \frac{A1}{A2}}{\pi} \right) \right] = \frac{In \frac{A1}{A2}}{\sqrt{\pi^2 + \left(In \frac{A1}{A2} \right)^2}}$$

- Bt = Total damping
- A1 = Amplitude of first peak
- A2 = Amplitude of second peak

Natural frequency (Fn) is primarily determined by the time to the first zero crossing. There is a small correction for damping as the time period will decrease slightly with the increase in damping.

$$Fn = \frac{1}{2T\sqrt{1 - Bt^2}} = \frac{1}{2TCos \left[\arctan \left(\frac{In \frac{A1}{A2}}{\pi} \right) \right]}$$

Sensitivity (G) is the most complex calculation. There are a number of variables that will have a direct effect on the sensitivity. The SMT-200 will fed a current into the coil which then move. The amount it moves will be dependent on the magnitude of the current and the moving mass.

$$G = \sqrt{\frac{2\pi Fn mA_1}{I}} e^{\frac{\arctan \frac{\sqrt{1 - Bt^2}}{Bt}}{\frac{Bt}{\sqrt{1 - Bt^2}}}}$$

- G = Sensitivity
- I = Current through geophone
- Bt = Total damping
- Fn = Frequency
- m = Mass

B.7 Distortion Test

The ideal geophone would convert movement into an exact electrical equivalent that can be fed to a recording system. This is not always possible. For instance the magnetic field within the element is more or less linear around the rest position in the centre of the magnet. As the moving mass approaches the limit of its travel it will start to encounter non linearities in the magnetic field around the poles of the magnet, hence the output will appear distorted.

TEST PRINCIPLE.....

The accepted way to measure distortion is to feed a low distortion signal into the unit under test and to measure the output voltage. Distortion will appear as harmonics of the signal fed into the unit under test (referred to as the fundamental). By analysing the output in the frequency domain using a Fast Fourier Transform (FFT.) the amplitude of each harmonic can be calculated. This can be expressed as a percentage of the fundamental.

In the case of the SMT-200 the test frequency is determined by the user but for each period during the recording interval, 32 samples are taken and averaged. The result is then converted to the frequency domain so a 32 point FFT can be applied to work out the fundamental, second and third harmonics. From this the final percentage distortion is calculated.

B.8 Distortion test drive mode

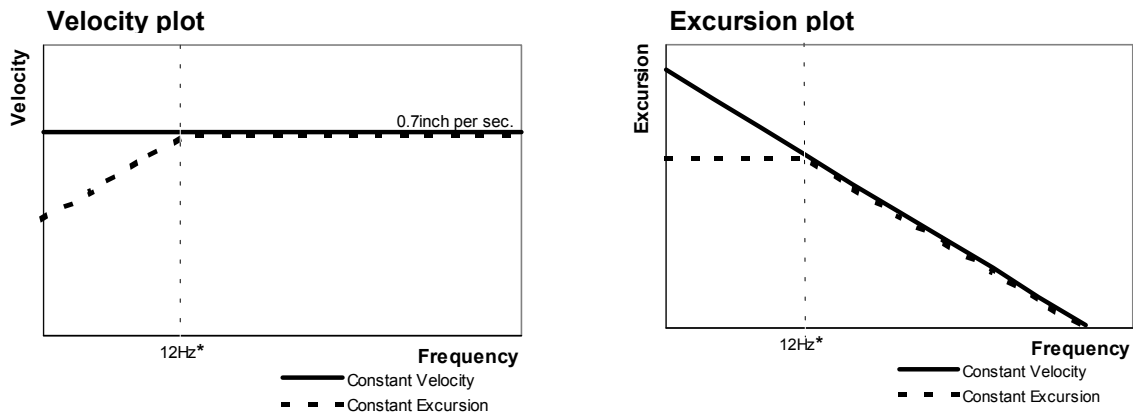

* Historical test frequency

Constant velocity mode

At constant velocity the distortion test drive level is fixed at 0.7 in/s (0.01778 m/s). The actual excursion that this produces will depend on the frequency of the drive signal and the geophone’s natural frequency. Lower drive frequencies will result in a proportional increase in the moving mass excursion. This increased movement could result in increased distortion value due to the geophone springs being driven into a non linear region.

Constant excursion mode

At constant excursion the test drive current (and so the drive level) is compensated to allow for testing at frequencies other than 12 Hz. By altering the drive level the excursion of the moving mass can be maintained at 0.236 mm, which is the same value as would have been produced driving the moving mass at 12 Hz with a 0.7 in/s drive. Thereby giving consistent results regardless of the distortion test frequency.

B.9 Continuous Impedance

Continuous impedance is somewhat like a resistance test but instead of a DC current an AC current at the geophones natural frequency is fed to the coil continually while the phone is under test. The coil will then oscillate as it is excited by the applied current. A coil that is stuck or moving abnormally will produce a different result than a freely moving coil. This facility makes this an excellent trouble-shooting test.

B.10 Low Drive Continuous Impedance

The low drive continuous impedance test applies a user defined low drive (default 10% of the nominal drive level) to the geophone string under test so that sticking or dragging coils can be found whereby if a higher drive level was used the coil would be freed.

B.11 Geophone String Resistance Calculation

Strings generally fall into two groups, series and series parallel.

B.11.1 Series String

1. First find the total resistance (R_t) of one geophone

$$R_t = \frac{R_c \times R_d}{R_c + R_d} \quad \text{Example..} \quad R_t = \frac{375 \times 1000}{375 + 1000} = 273 \Omega$$

R_d = Damping Resistor

R_c = Coil Resistance

2. Next multiply the above figure by the number of geophones in the string

$$R_s = n \times R_t \quad \text{Example..} \quad R_s = 6 \times 273 = 1638 \Omega$$

R_s = String Resistance

N = Number of geophones

R_t = 273Ω

n = 6

3. String resistance in this case is 1638Ω .

B.11.2 Series Parallel String

First find the resistance of one parallel branch. For example if the string was configured as a 6 x 3 string this would mean there are 6 series geophones and 3 parallel branches. The formulas used in B.8.1 can be used for this. In that particular instance we would end up with a branch resistance of 1638Ω . Divide this number by the number of branches.

$$R_t = \frac{R_b}{n} \quad R_t = \frac{1638}{3} = 546 \Omega$$

B.12 Damping Calculations

It may be necessary at some stage to modify a geophone to achieve a particular level of damping. The following calculations will assist in achieving the correct damping.

Damping constant, $RtBcFn$, is given by :

$$RtBcFn = \frac{Go^2}{4\pi m}$$

- Rt = Total geophone resistance
- Rc = Coil resistance
- Rs = Shunt resistance
- Bt = Total damping
- Bc = Coil damping
- Bo = Open circuit damping
- Fn = Natural Frequency
- Go = Open circuit sensitivity
- m = Suspended mass

Example..

SM-4 10 Hz 375 Ω to achieve 0.70 damping

$$RtBcFn = \frac{28.8^2}{4\pi \times 0.011} = 6000 \Omega \text{ Hz}$$

$$Bc = Bt - Bo = 0.70 - 0.25 = 0.45$$

$$Rt = \frac{RtBcFo}{BcFo} = \frac{6000}{0.45 \times 10} = 1333 \Omega$$

$$Rs = Rt - Rc = 1333 - 375 = 958 \Omega$$

From Spec sheet:

- Bo = 0.25
- Go = 28.8 V/m/s
- Fn = 10 Hz
- m = 11 grams
- π = 3.142

The nearest value of resistor to this is 1 K Ω . Recalculating with this value the damping for this element turns out to be 0.69.

B.13 Temperature Compensation

Temperature compensation that is done either on the specs themselves or the recorded data will be calculated as follows:

$$Rt = Rs + 0.004Rs(t - Tspec)$$

$$Bt = Bs - 0.002Bs(t - Tspec)$$

$$Gt = Gs$$

- Rt = Resistance at temperature t
- Rs = Resistance at 20 °C
- Bs = Damping at 20 °C
- Bt = Damping at temperature t
- Gt = Sensitivity at temperature t
- Gs = Sensitivity at 20 °C
- t = Temperature
- $Tspec$ = Geophone temperature spec.

Appendix C

Parts List

Page intentionally left blank

**C.1 SMT-200 Geophone Tester****Resistors**

Reference	Part	Part Number	
R4	100Ω	SMT-200	T 0001
R29,R35	100k	SMT-200	T 0002
R48	10Ω	SMT-200	T 0003
R15,R23,R36,R51	10k	SMT-200	T 0004
R28	10M	SMT-200	T 0005
R43	120k	SMT-200	T 0006
R46	15k	SMT-200	T 0007
R21	160k	SMT-200	T 0008
R41	1Ω	SMT-200	T 0009
R18,R58	1k	SMT-200	T 0010
R7,R42	1k21	SMT-200	T 0011
R5	1k27	SMT-200	T 0012
R27	1M	SMT-200	T 0013
R6	200Ω	SMT-200	T 0014
R24	20k	SMT-200	T 0015
R47	22k	SMT-200	T 0016
R59	270Ω	SMT-200	T 0017
R13	270k	SMT-200	T 0018
R39	2k0Ω	SMT-200	T 0019
R37	300k	SMT-200	T 0020
R20	324k	SMT-200	T 0021
R2,R14	33Ω	SMT-200	T 0022
R45	33k	SMT-200	T 0023
R38	36k	SMT-200	T 0024
R12	3M48	SMT-200	T 0025
R25	40k2	SMT-200	T 0026
R17	499Ω	SMT-200	T 0027
R30	499Ω .1% Ref.	SMT-200	T 0028
R1,R8,R9,R31,R32,R33,R34,R49, R50, R52,R53,R54,R55,R56, R57, R60	4k7	SMT-200	T 0029
R16,R22	4k99	SMT-200	T 0030
R40	5k6	SMT-200	T 0031
R19	649k	SMT-200	T 0032
R3	66k5	SMT-200	T 0033
R44	68k	SMT-200	T 0034
R26	80k6	SMT-200	T 0035
R10,R11	Trim Pot 100k	SMT-200	T 0036
EMC1,EMC2,EMC3,EMC4	GND Resistor Option	SMT-200	T 0037

Capacitors

Reference	Part	Part Number
C23,C32,C33,C34,C35,C36,C37, C38,C40,C41,C42,C43,C44,C45,C46 ,C51	100nF	SMT-200 T 0038
C53	100nF	SMT-200 T 0039
C15,C17, C30, C31	100pF 1000V CER	SMT-200 T 0040
C21	100uF 63V Vert. (high quality)	SMT-200 T 0041
C12,C22	10n	SMT-200 T 0042
C27,C39	10uF 25V Tant.	SMT-200 T 0043
C6, C52	1uF	SMT-200 T 0044
C10	1uF 35V Tant.	SMT-200 T 0045
C3,C8,C9,C13,C14,C18,C19,C47, C48,C49,C50	220nF	SMT-200 T 0046
C28	220uF 35V Vert.	SMT-200 T 0047
C26	270pF	SMT-200 T 0048
C1,C2	2u2F 25V Tant.	SMT-200 T 0049
C5	330nF	SMT-200 T 0050
C20	330uF 16V Vert.	SMT-200 T 0051
C24,C25	33uF 25V Tant.	SMT-200 T 0052
C29	470p	SMT-200 T 0053
C4,C7,C16	47nF	SMT-200 T 0054
C11	56nF	SMT-200 T 0055

Semiconductors

Reference	Part	Part Number
D3,D4,D5,D6,D7,D8,D12,D13	1N4006	SMT-200 T 0056
D1,D2,D10	1N4148	SMT-200 T 0057
U12	27C1024 PLCC44	SMT-200 T 0058
U9	74C922	SMT-200 T 0059
U15	74HCT153	SMT-200 T 0060
U10	74HCT4040	SMT-200 T 0061
U5	82C55 PLCC44	SMT-200 T 0062
U7	AD7111	SMT-200 T 0063
U6	ADS7807P	SMT-200 T 0064
A8200112 PCB assm II PC/104 Mod	Ampro CoreModule/PC 2 MB	SMT-200 T 0065
D11	B2T03C16	SMT-200 T 0066
Q4	BC517	SMT-200 T 0067
U19	Brandner SH3W2-23 or Traco TEF2022	SMT-200 T 0068
Q1,Q2,Q3,Q5,Q6	BS170	SMT-200 T 0069
Q7	BS250	SMT-200 T 0070
U22	CD4093	SMT-200 T 0071
U3	CD74HCT00	SMT-200 T 0072
U1	CD74HCT139	SMT-200 T 0073
U2	CD74HCT245	SMT-200 T 0074
U4,U14	CD74HCT30	SMT-200 T 0075
U11	DAC707	SMT-200 T 0076
U16	DG408DJ / ADG408BN	SMT-200 T 0077
U18	DG409DJ / ADG409BN	SMT-200 T 0078



Reference	Part	Part Number
U23	LF356	SMT-200 T 0079
U20	LM2575T-5.0	SMT-200 T 0080
A8200112 PCB assembly II Flash disk	M-Systems DiskOnChip 2000 2 MB	SMT-200 T 0081
U21	MAX8211EPA	SMT-200 T 0082
U8	OP200	SMT-200 T 0083
U17	OP400	SMT-200 T 0084
A8200117 Frame complete LCD JP8a	Seiko text/graphics LCD 128 x 128, LED backlight	SMT-200 T 0085
U13	Smartec Temperature Sensor SMT-160	SMT-200 T 0086
U24	TL497	SMT-200 T 0087
D9	UF4002	SMT-200 T 0088

Miscellaneous

Reference	Part	Part Number
A8200101 PC/104 Flat cables JP5b, JP6b	10 pin Female flat cable connector	SMT-200 T 0089
L2	100uH micro	SMT-200 T 0090
L1	470uH 0.5 A	SMT-200 T 0091
JP5b	Batt. Voltage / Leakage Range Selector	SMT-200 T 0092
A8200102 Beeper wiring Black wire	Black wire flex 0.15 mm2	SMT-200 T 0094
F1,F2	BOURNS MULTIFUSE	SMT-200 T 0095
A8200101 PC/104 Flat cables JP5b, JP6b	Coloured flat cable 10 pole	SMT-200 T 0096
A8200104 Input connector cable wiring loom	Coloured flat cable 40 pole	SMT-200 T 0097
A8200117 Frame LCD dust barrier	Draft-strip Cell Foam	SMT-200 T 0098
A8200141 Case bottom assembly I L3,L4	Fabory 3FB30, St., zinc plated, yell.pasified	SMT-200 T 0099
JP1a	Filter DSS310-55Y5S 223S50	SMT-200 T 0100
JP3a	Geo/Smart/Start connector 26 PIN MALE	SMT-200 T 0101
JP4a	HEADER 34 X 2 PINS for PC104	SMT-200 T 0102
A8200102 Beeper wiring	Header single row haaks 13pin for keypad & beeper	SMT-200 T 0103
A8200121 Case top assembly I	Header socket 2 way	SMT-200 T 0104
A8200121 Case top assembly I	Isolatie tape	SMT-200 T 0105
BT1	Lexan display window	SMT-200 T 0106
A8200147 Case bottom assembly IV	Lithium battery backup	SMT-200 T 0107
A8200147 Case bottom assembly IV	M2 Lock washer	SMT-200 T 0108
A8200117 Frame complete	M2 x 5 Slotted cheese head screw	SMT-200 T 0109
A8200149 Case bottom complete	M2,5 Lock washer	SMT-200 T 0110
A8200117 Frame complete	M2,5 x 4 Slotted counter sunk screw	SMT-200 T 0111
A8200111 PCB assembly I	M2,5 x 8 Slotted cheese head screw	SMT-200 T 0112
A8200149 Case bottom complete	M3 Lock washer	SMT-200 T 0113
A8200149 Case bottom complete	M3 x 10 Hex. socket head cap screw	SMT-200 T 0114
A8200147 Case bottom assembly IV	M3 x 10 Phillips cross recessed counter sunk screw	SMT-200 T 0115
A8200111 PCB assembly I	M3 x 12 Phillips cross recessed counter sunk screw	SMT-200 T 0116
A8200111 PCB assembly I	M3 x 8 Phillips cross recessed cheese head screw	SMT-200 T 0117
A8200111 PCB assembly I	M4 Lock washer	SMT-200 T 0118
A8200114 PCB support assemblies	M4 Lock washer	SMT-200 T 0119



Reference	Part	Part Number	
A8200114	PCB support assemblies	M4 Lock washer	SMT-200 T 0120
A8200115	Frame assembly	M4 Lock washer	SMT-200 T 0121
A8200145	Case bottom assembly III	M4 Nut	SMT-200 T 0122
A8200145	Case bottom assembly III	M4 Nylon double retaining ring	SMT-200 T 0123
A8200150	Case complete	M4 Nylon rozet ring black	SMT-200 T 0124
A8200145	Case bottom assembly III	M4 Self locking nut	SMT-200 T 0125
A8200114	PCB support assemblies	M4 x 10 Hex. socket counter sunk screw	SMT-200 T 0126
A8200114	PCB support assemblies	M4 x 10 Hex. socket counter sunk screw	SMT-200 T 0127
A8200150	Case complete	M4 x 10 Hex. socket counter sunk screw	SMT-200 T 0128
A8200115	Frame assembly	M4 x 40 Hex. socket head cap screw	SMT-200 T 0129
A8200111	PCB assembly I	M4 x 6 Hex. socket head cap screw	SMT-200 T 0130
A8200123	Case top assembly II	M4 x 8 Hex. socket counter sunk screw	SMT-200 T 0131
A8200147	Case bottom assembly IV	Male slide plate contacts	SMT-200 T 0132
JP2a,JP6a		PCB 10 PIN CONNECTOR MALE	SMT-200 T 0133
A8200102	Beeper wiring LS1	Piezo buzzer	SMT-200 T 0134
A8200111	PC/104 supp. pillar	Pillar M 3 x 16	SMT-200 T 0135
A8200102	Beeper wiring Red wire	Red wire flex 0.15 mm2	SMT-200 T 0136
K1		Relay SPCO pin out 1	SMT-200 T 0137
Silica Gel		Silica Gel 10g	SMT-200 T 0138
A8200121	Case top assembly I	Silicone sealant	SMT-200 T 0139
A8200117	Frame LCD conn. JP8b	Single row thru header - 22 turned pin contacts	SMT-200 T 0140
A8200149	Case bottom complete	SMT 200 Battery lock plate	SMT-200 T 0141
A8200111	SMT-200 PCB assembly I	SMT-200 Analogue PCB Rev. 7.0	SMT-200 T 0142
A8200149	Case bottom complete	SMT-200 Battery lock spring	SMT-200 T 0143
A8200141	Case bottom assembly I	SMT-200 Case bottom (Composite)	SMT-200 T 0144
A8200121	Case top assembly I	SMT-200 Case seal	SMT-200 T 0145
A8200121	Case top assembly I	SMT-200 Case top (Composite)	SMT-200 T 0146
A8200114	PCB support assemblies	SMT-200 Distance post I	SMT-200 T 0147
A8200114	PCB support assemblies	SMT-200 Distance post II	SMT-200 T 0148
A8200115	Frame assembly	SMT-200 Distance tube I	SMT-200 T 0149
A8200115	Frame assembly	SMT-200 Distance tube II	SMT-200 T 0150
A8200115	Frame assembly	SMT-200 Distance tube III	SMT-200 T 0151
A8200123	Case top assembly II	SMT-200 Keypad	SMT-200 T 0152
A8200130	Case top complete	SMT-200 Keypad overlay	SMT-200 T 0153
A8200117	Frame complete	SMT-200 LCD Display Support	SMT-200 T 0154
A8200147	Case bottom assembly IV	SMT-200 Male slide plate	SMT-200 T 0155
A8200147	Case bottom assembly IV	SMT-200 Male slide plate, Contact block	SMT-200 T 0156
A8200145	Case bottom assembly III	SMT-200 Male slide plate, Contact pin	SMT-200 T 0157
A8200114	PCB support assemblies	SMT-200 PCB Support Front	SMT-200 T 0158
A8200114	PCB support assemblies	SMT-200 PCB Support Rear	SMT-200 T 0159
A8200115	Frame assembly	SMT-200 PCB Support Sides	SMT-200 T 0160
A8200141	Case bottom assembly I	SMT-200 Shoulder strap mounting ring	SMT-200 T 0161
A8200115	Frame assembly	SMT-200 Threaded bush I	SMT-200 T 0162
A8200111	PCB assembly I	SMT-200 Threaded bush II	SMT-200 T 0163
A8200115	Frame assembly	SMT-200 Threaded bush II	SMT-200 T 0164
A8200104	Input conn. Cable loom	Solder lug, hole dia. 4.1	SMT-200 T 0165
A8200149	Case bottom Serial No.	Tamper proof aluminium sticker SERIAL NO.	SMT-200 T 0166
A8200112	Flashdisk Ty wrap	Ty wrap 100 mm	SMT-200 T 0167
JP8a		Ultra Low Profile Sockets for LCD	SMT-200 T 0168
U5, U12 IC socket		WIN WPLCC044 - 1T	SMT-200 T 0169

**C.2 SMT-200 Battery Pack****Miscellaneous**

Reference	Part	Part Number	
A8200220 SMT-200 Battery Pack	SMT-200 Battery Pack	SMT-200	B 0200
BT1	Battery 12V 1.2Ah	SMT-200	B 0201
A8200211 Bottom assembly	SMT-200 Female slide plate (battery pack)	SMT-200	B 0202
A8200211 Bottom assembly	SMT-200 Female slide plate, insulation plate	SMT-200	B 0203
A8200211 Bottom assembly	SMT-200 Female slide plate + contact	SMT-200	B 0204
A8200211 Bottom assembly	SMT-200 Female slide plate - contact	SMT-200	B 0205
A8200211 Bottom assembly	SMT-200 Battery pack, slide retainer plate	SMT-200	B 0206
A8200201 Wires	M3 solder lug	SMT-200	B 0207
A8200201 Wires	Red wire	SMT-200	B 0208
A8200201 Wires	Black wire	SMT-200	B 0209
A8200211 Bottom assembly	M2,5 Nut	SMT-200	B 0210
A8200211 Bottom assembly	M3 x 12 Phillips cross recessed counter sunk screw	SMT-200	B 0211
A8200220 Complete	Bison Bisonite 2-component glue	SMT-200	B 0212
A8200220 Complete	SMT-200 Battery pack seal	SMT-200	B 0213
A8200211 Bottom assembly	SMT-200 Battery pack bottom (Composite)	SMT-200	B 0214
A8200220 Complete	SMT-200 Battery pack top (Composite)	SMT-200	B 0215
A8200201 Wires Fx	Bourns multifuse U185	SMT-200	B 0216

C.3 SMT-200 Docking Station

Resistors

Reference	Part	Part Number
R15,R31	0.5Ω / 0.5W	SMT-200 DS 0300
R38	0Ω	SMT-200 DS 0301
R13,R29	100Ω	SMT-200 DS 0302
R14,R18,R30,R32	100k	SMT-200 DS 0303
R12,R28,R39,R40	10k	SMT-200 DS 0304
R11,R27	11k	SMT-200 DS 0305
R10,R26	121k	SMT-200 DS 0306
R19,R33	12k	SMT-200 DS 0307
R41,R42	1k	SMT-200 DS 0308
R21,R22,R35,R36	2k2	SMT-200 DS 0309
R5	2k7	SMT-200 DS 0310
R16	422Ω	SMT-200 DS 0311
R7,R23	470/1W	SMT-200 DS 0312
R20,R34	470Ω	SMT-200 DS 0313
R8,R24	4k53	SMT-200 DS 0314
R9,R25	52k3	SMT-200 DS 0315
R17,R37	82Ω5	SMT-200 DS 0316

Capacitors

Reference	Part	Part Number
C23,C24	100nF	SMT-200 DS 0317
C3	100uF 25V	SMT-200 DS 0318
C1	100uF 40V	SMT-200 DS 0319
C18,C21	15nF	SMT-200 DS 0320
C17,C20	1nF	SMT-200 DS 0321
C22	1uF	SMT-200 DS 0322
C12	220nF	SMT-200 DS 0323
C2	4700uF 40V	SMT-200 DS 0324
C16	470uF 25V	SMT-200 DS 0325
C19	47uF 25V	SMT-200 DS 0326

Semiconductors

Reference	Part	Part Number
D3,D6	1N4001	SMT-200 DS 0327
D4,D7	1N4148	SMT-200 DS 0328
B1	B80C3700/2200 SIC	SMT-200 DS 0329
Q4,Q8	BC547B	SMT-200 DS 0330
Q3,Q5,Q7,Q9,Q10,Q11	BC557B	SMT-200 DS 0331
Q2,Q6	BD238	SMT-200 DS 0332
A8200305 LED & geo cable D5, D8	DUAL LED CC	SMT-200 DS 0333
A8200305 LED & geo cable D2	LED Green	SMT-200 DS 0334
U1	LM7805	SMT-200 DS 0335
U6,U7	UC3906	SMT-200 DS 0336

**Miscellaneous**

Reference	Part	Part Number
A8200301 Mains wiring	1/4" Female right angled push-on terminal	SMT-200 DS 0337
A8200301 Mains wiring	1/4" Female right angled push-on terminal cover	SMT-200 DS 0338
A8200301 Mains wiring	3/16" Push on terminal	SMT-200 DS 0339
A8200301 Mains wiring	3/16" Push on terminal cover	SMT-200 DS 0340
A8200323 Case assembly II	RED banana socket	SMT-200 DS 0341
A8200323 Case assembly II	YELLOW banana socket	SMT-200 DS 0342
A8200323 Case assembly II	BLACK banana socket	SMT-200 DS 0343
J1	CONNECTOR CENT24S pcb 90o Female	SMT-200 DS 0344
P1	DB9s PCB angled	SMT-200 DS 0345
Docking Station PCB	Docking Station PCB REV 7.0	SMT-200 DS 0346
A8200303 Serial connector wiring	Flat cable 10 pole	SMT-200 DS 0347
A8200305 LED & geo cable	Flat cable 16 pole	SMT-200 DS 0348
A8200303 Serial connector wiring	Flat cable connector 10 pin	SMT-200 DS 0349
A8200305 LED & geo cable	Flat cable connector 14 pin	SMT-200 DS 0350
A8200313 Chassis assembly III	Fuse 250V 500mA T	SMT-200 DS 0351
A8200313 Chassis assembly III	Fuse holder	SMT-200 DS 0352
A8200312 Chassis assembly II	M 3 x16 pillar	SMT-200 DS 0353
A8200321 Case assembly I	M2 Lock washer	SMT-200 DS 0354
A8200321 Case assembly I	M2 x 5 Slotted cheese head screw	SMT-200 DS 0355
A8200312 Chassis assembly II	M3 Lock washer	SMT-200 DS 0356
A8200311 Chassis assembly I	M3 Lock washer	SMT-200 DS 0357
J1 securing lock washer	M3 Lock washer	SMT-200 DS 0358
A8200321 Case assembly I	M3 Self lock nut	SMT-200 DS 0359
A8200301 Mains wiring	M3 solder lug	SMT-200 DS 0360
A8200312 Chassis assembly II	M3 Washer	SMT-200 DS 0361
A8200321 Case assembly I	M3 Washer	SMT-200 DS 0362
A8200321 Case assembly I	M3 x 12 Phillips cross recessed count. sunk screw	SMT-200 DS 0363
A8200312 Chassis assembly II	M3 x 12 Slotted pan head screw	SMT-200 DS 0364
T1 securing screw	M3 x 12 Slotted pan head screw	SMT-200 DS 0365
A8200330 Complete	M3 x 6 Phillips cross recessed counter sunk screw	SMT-200 DS 0366
A8200311 Chassis assembly I	M3 x 8 Phillips recessed cheese head screw	SMT-200 DS 0367
J1 securing screw	M3 x 8 Phillips recessed cheese head screw	SMT-200 DS 0368
A8200321 Case assembly I	M4 Nut	SMT-200 DS 0369
A8200325 Case complete	M4 Self lock nut	SMT-200 DS 0370
A8200305 LED & geo cable	M4 Solder lug	SMT-200 DS 0371
A8200313 Chassis assembly III	Mains filter Schurter 5110-3-43	SMT-200 DS 0372
JP6	Mains PCB Connector 4-p kroonsteen	SMT-200 DS 0373
A8200313 Chassis assembly III	Mains switch DPDT	SMT-200 DS 0374
A8200321 Case assembly I	Nylon Double Retaining Washer	SMT-200 DS 0375
A8200311 Chassis assembly I	Nylon insert feet Black	SMT-200 DS 0376
JP4, JP5	PCB MOUNTING HEADER 14 PIN	SMT-200 DS 0377
K1	Relay SPCO pin out 1	SMT-200 DS 0378
JP3	RJ-11 6p4c Modem PCB Angled	SMT-200 DS 0379
A8200303 Serial connector wiring	RS 232 Connector 9 pin female	SMT-200 DS 0380
A8200305 LED & geo cable	Rubber tube A0	SMT-200 DS 0381
A8200301 Mains wiring	Rubber tube A1	SMT-200 DS 0382
A8200321 Case assembly I	Set male slide plate contacts	SMT-200 DS 0383

Reference	Part	Part Number
A8200321 Case assembly I	SMT-200 Docking station case	SMT-200 DS 0384
A8200311 Chassis assembly I	SMT-200 Docking station Connector plate	SMT-200 DS 0385
A8200325 Case complete	SMT-200 Docking station LED tube	SMT-200 DS 0386
A8200330 Complete	SMT-200 Docking station overlay	SMT-200 DS 0387
A8200321 Case assembly I	SMT-200 Male slide plate	SMT-200 DS 0388
A8200321 Case assembly I	SMT-200 Male slide plate contact block	SMT-200 DS 0389
A8200321 Case assembly I	SMT-200 Male slide plate contact pin	SMT-200 DS 0390
A8200317 Chassis complete	Sub-D screw set	SMT-200 DS 0391
A8200330 Complete	Tamper Proof Aluminium Sticker	SMT-200 DS 0392
A8200311 Chassis assembly I	TO-220 Isolation plate (Silicone)	SMT-200 DS 0393
T1	TRANSFORMER 2X18V	SMT-200 DS 0394
A8200312 Chassis assembly II	Transistor isolation ring IS-560	SMT-200 DS 0395
A8200301 Mains wiring	Ty Wrap 100 mm	SMT-200 DS 0396
A8200301 Mains wiring	Voltage selector switch	SMT-200 DS 0397
A8200301 Mains wiring	Wire Black	SMT-200 DS 0398
A8200301 Mains wiring	Wire Blue	SMT-200 DS 0399
A8200301 Mains wiring	Wire Red	SMT-200 DS 0400
A8200301 Mains wiring	Wire White	SMT-200 DS 0401

C.4 SMT-200 Accessories and Cables

Miscellaneous

Reference	Part	Part Number
Mains Cable Euro	Mains Cable Euro	SMT-200 C 0500
Mains Cable North American	Mains Cable North American	SMT-200 C 0501
Mains Cable UK	Mains Cable UK	SMT-200 C 0502
Serial cable 9 pin	RS232 cable 9 pin male - female 1,8 m	SMT-200 C 0503
Serial cable adapter 9 to 25 pin	RS232 adapter 9 to 25 pin	SMT-200 C 0504
SMT-100/150/200 Reference geophone	Reference geophone	SMT-200 C 0505
SMT-100/200 Earth leakage probe	Earth leakage probe	SMT-200 C 0506
Temperature probe	Temperature probe	SMT-200 C 0507
Geophone interconnect cable	A8200511 Geophone interconnect cable	SMT-200 C 0508
SMT-100 to Docking Station cable	SMT-100 to Docking Station cable	SMT-200 C 0509
Spare mains fuse	Fuse 250V 500mA T	SMT-200 C 0510
Shoulder Strap incl. case mounting studs	Shoulder strap	SMT-200 C 0511
SMT-200 Transport case	Transport case (Yellow 1220 & Black)	SMT-200 C 0512
Software SMT-200 & Docking Station	SMT-200 Software Version 2.00	SMT-200 C 0513
SMT-200 Operators & Service Manual	SMT-200 Manual Ver 2.00	SMT-200 C 0514
Diagnostics test plug	SMT-200 Diagnostics test plug	SMT-200 C 0515
Tag reader gun	SMT-200 Tag reader gun complete	SMT-200 C 0516
v2.00 software diskette	SMT-200 v2.00 software diskette	SMT-200 C 0517
v2.00 software upgrade kit	SMT-200 v2.00 software upgrade kit	SMT-200 C 0518

Appendix D

Schematics & Layouts

Page intentionally left blank



D.1 SMT-200 Schematics

D.1.1 SMT-200 Geophone Tester

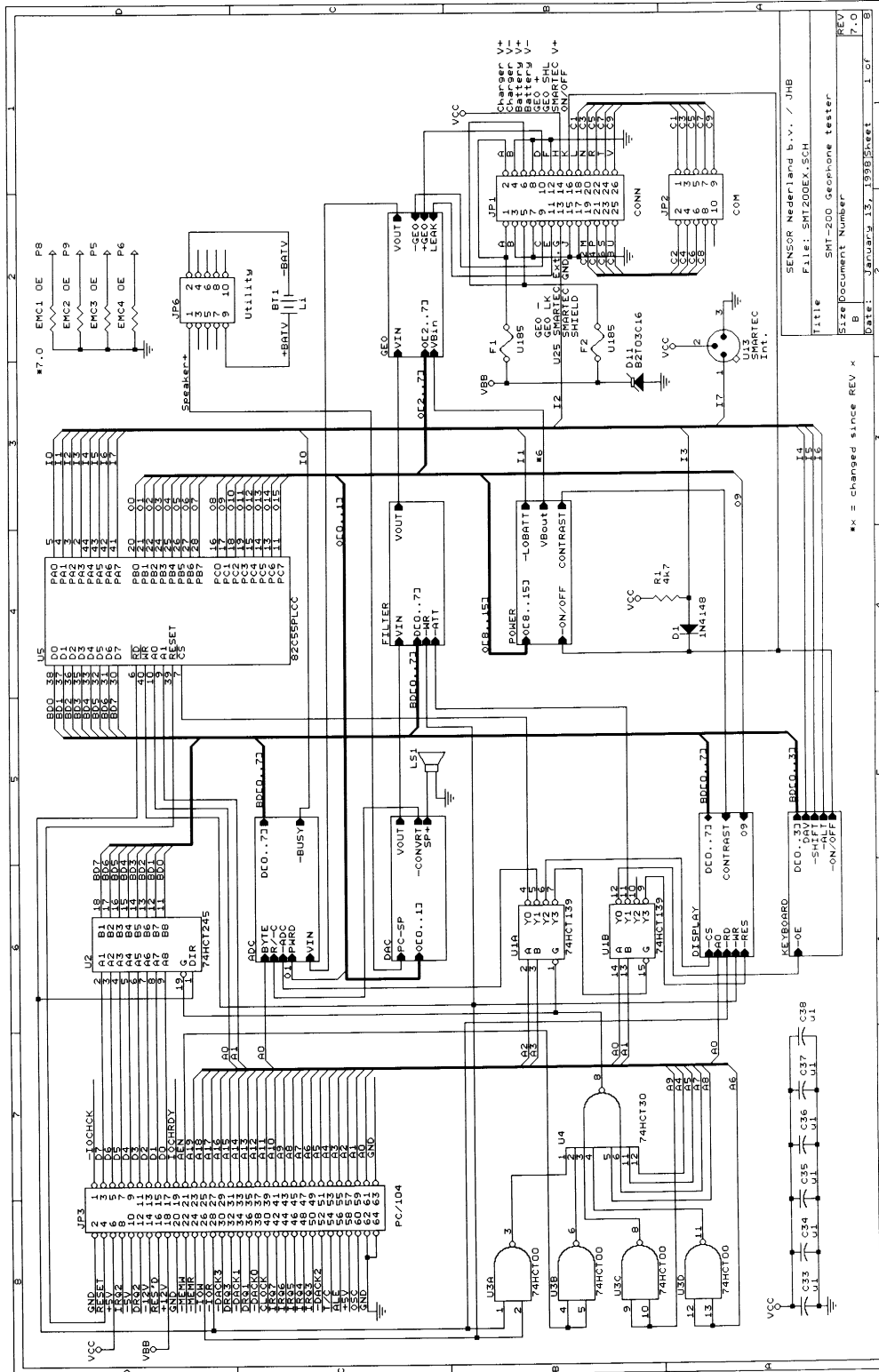

D.1.2 SMT-200 ADC

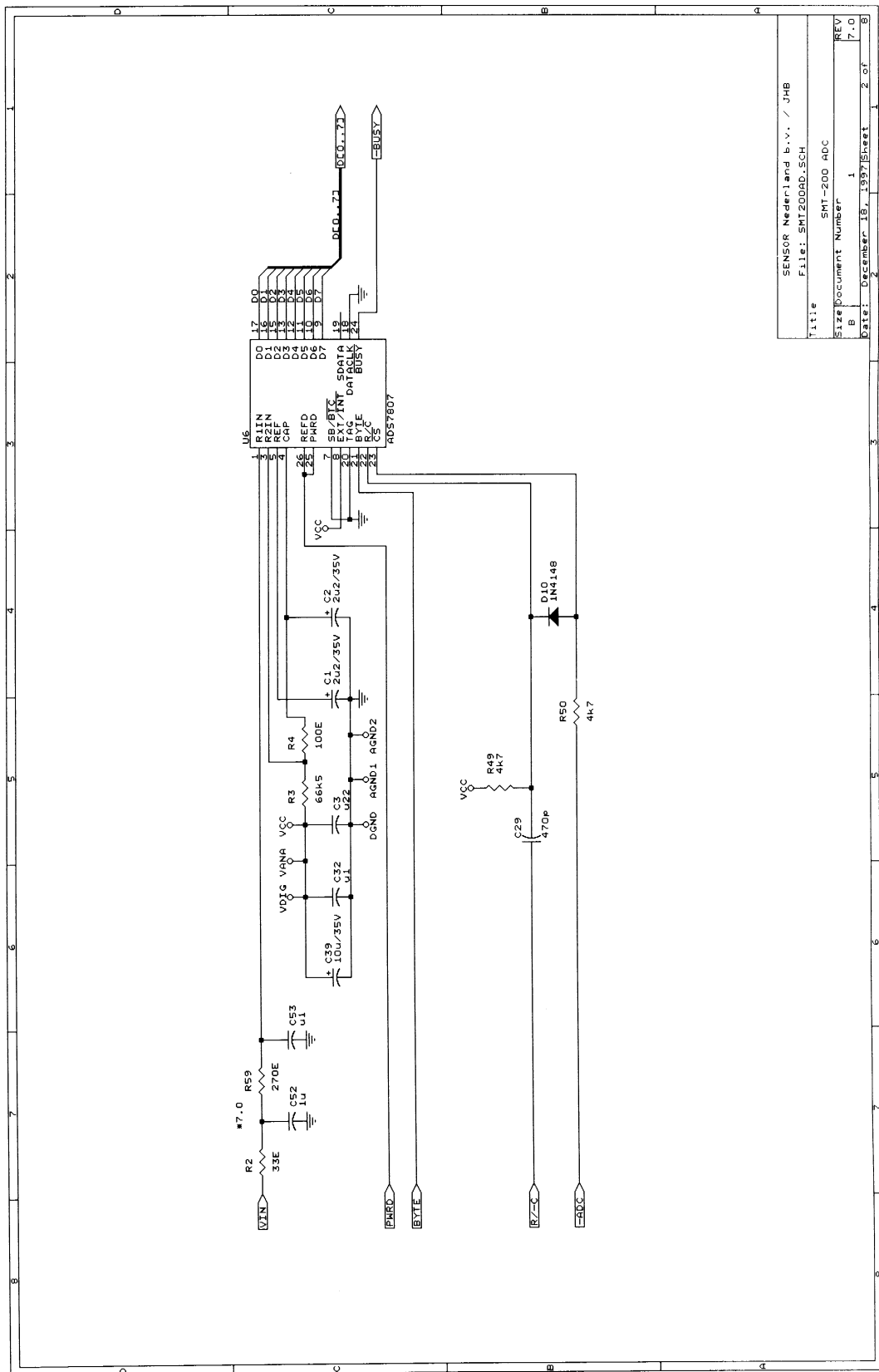



D.1.3 SMT-200 Filter

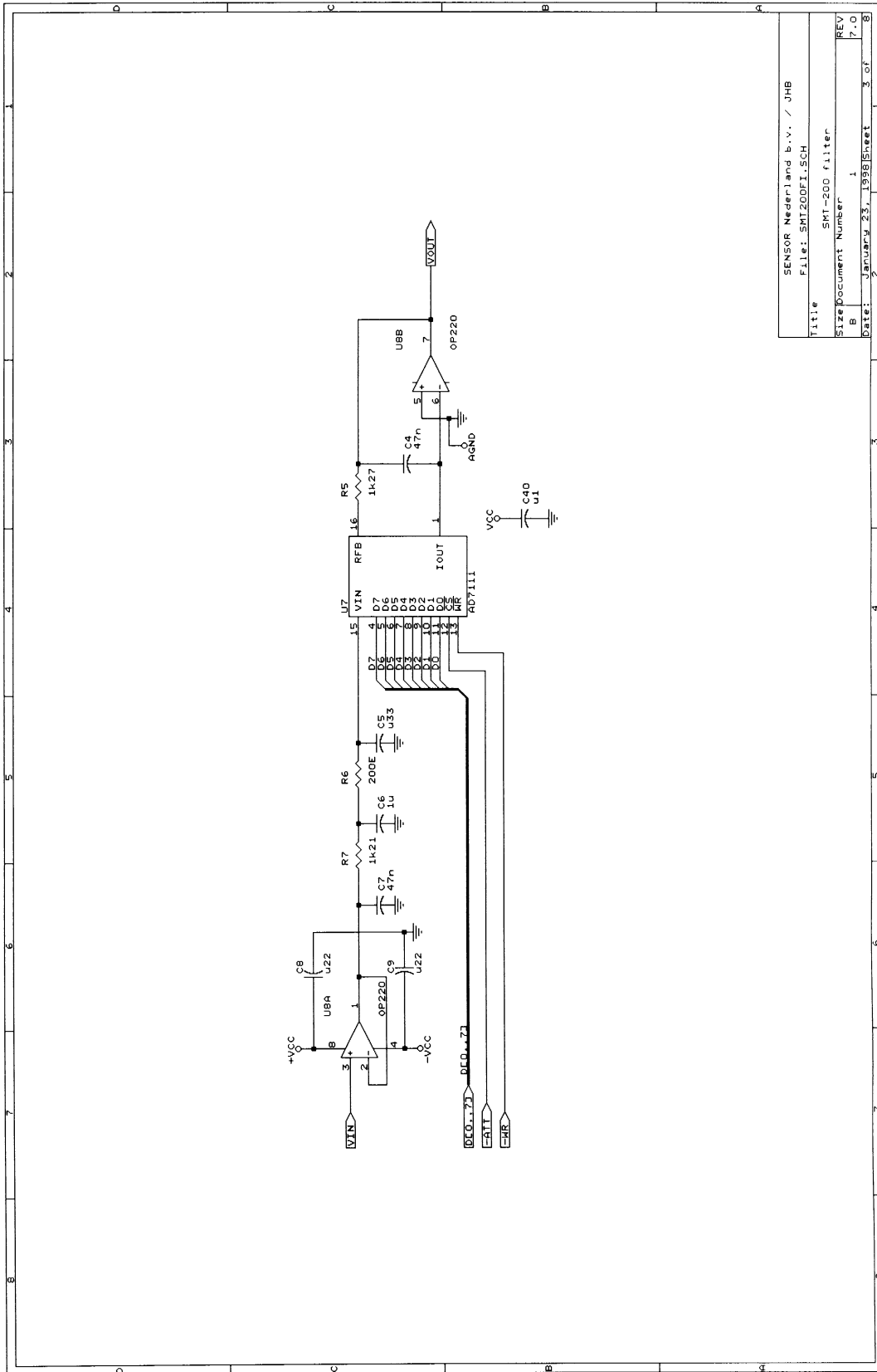

Title	SENSOR Nederland b.v. / JHB
File:	SMT200FI.SCH
Size	SMT-200 filter
Document Number	1
REV	7.0
Date:	January 23, 1998
Sheet	3 of 8

D.1.4 SMT-200 Keyboard

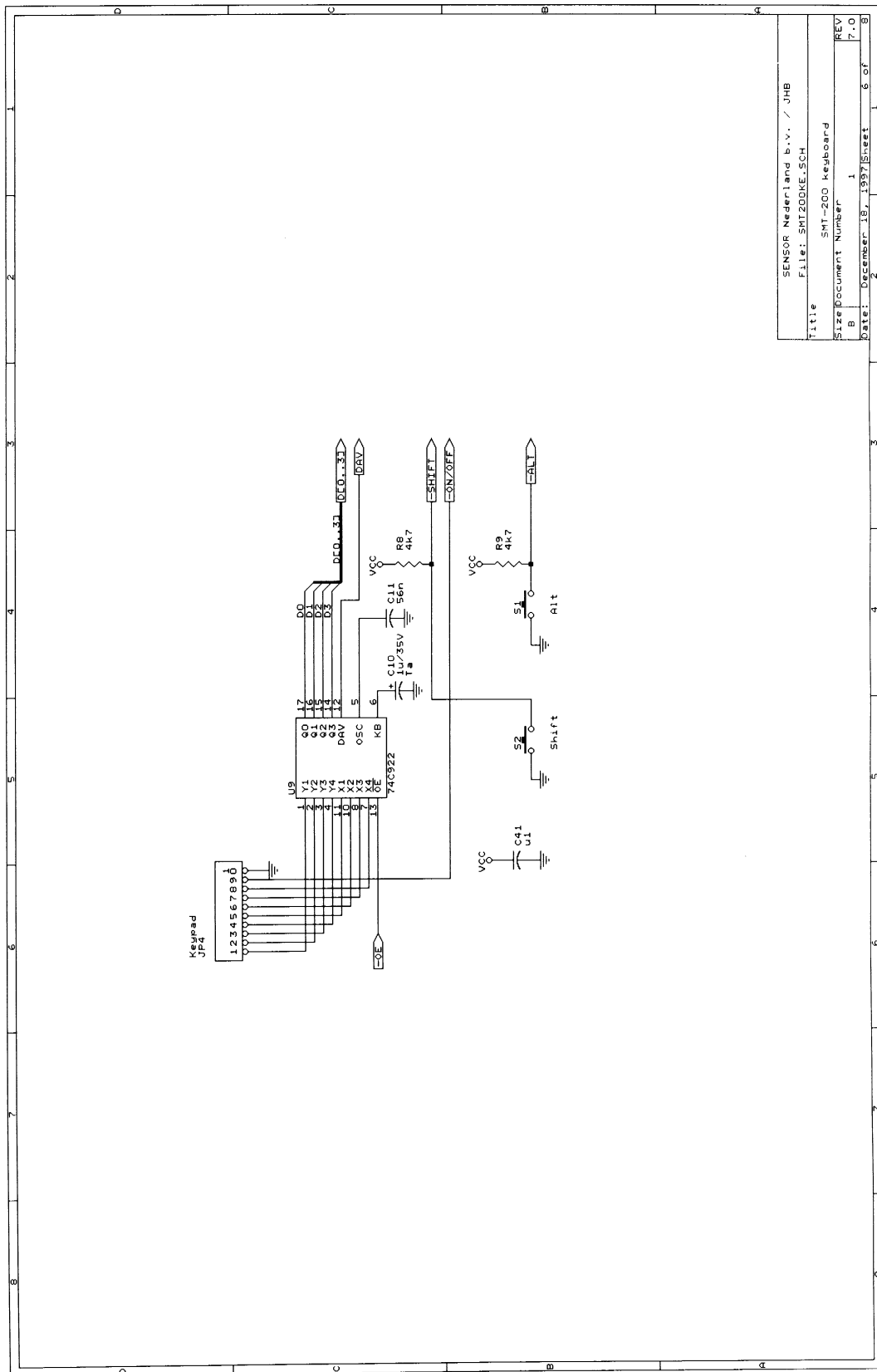

SENSOR Nederland b.v. / JHB	
Title	File: SMT200KE.SCH
Size	SMT-200 keyboard
Document Number	1
REV	7.0
Date	December 18, 1997
Sheet	6 of 8



D.1.5 SMT-200 DAC

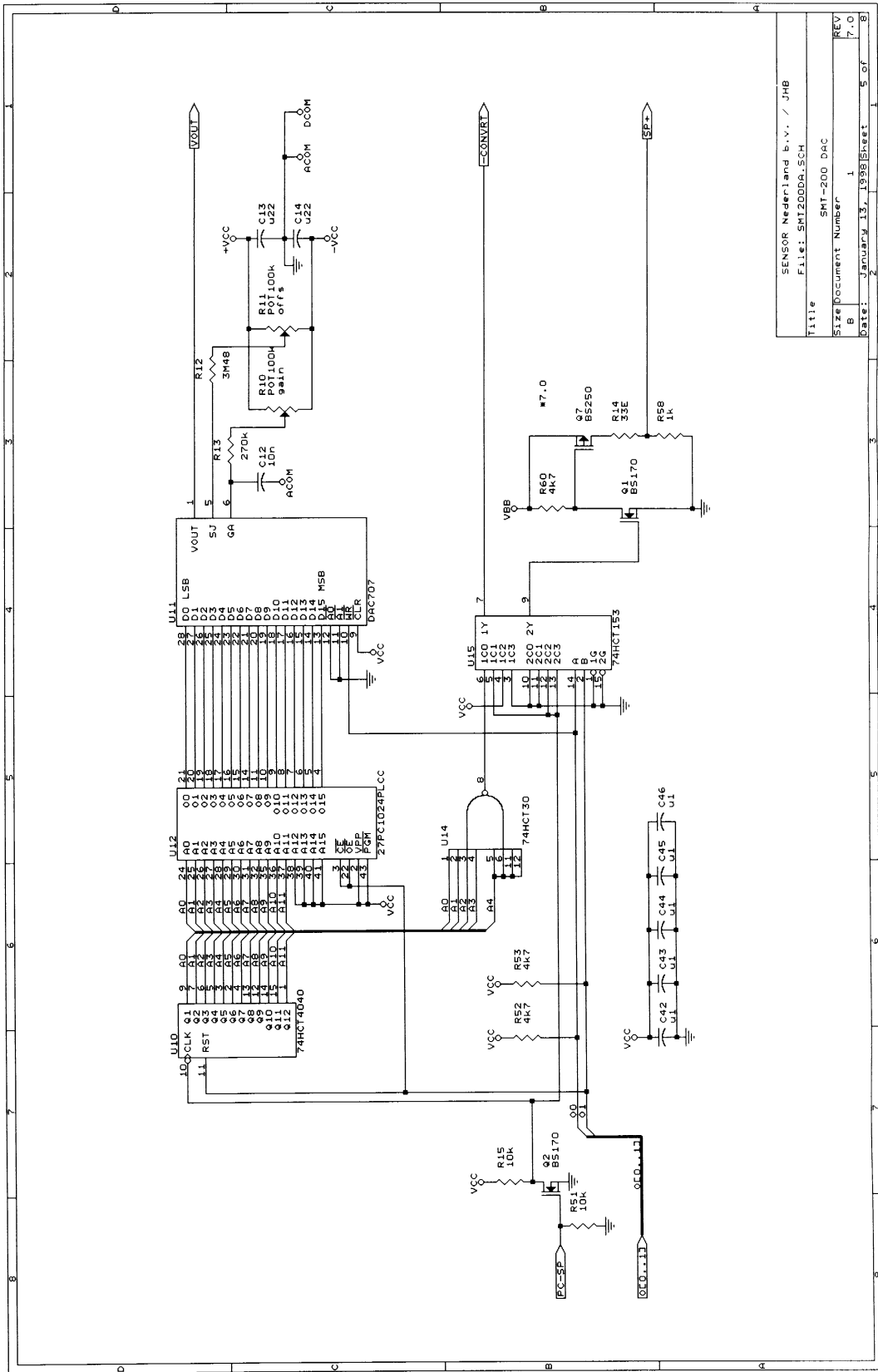

SENSOR Nederland b.v. / JHB	
Title: SMT200DA.SCH	
Size	SMT-200 DAC
Document Number	1
REV	7.0
Date	January 13, 1998
Sheet	5 of 8

D.1.6 SMT-200 Geophone Circuit

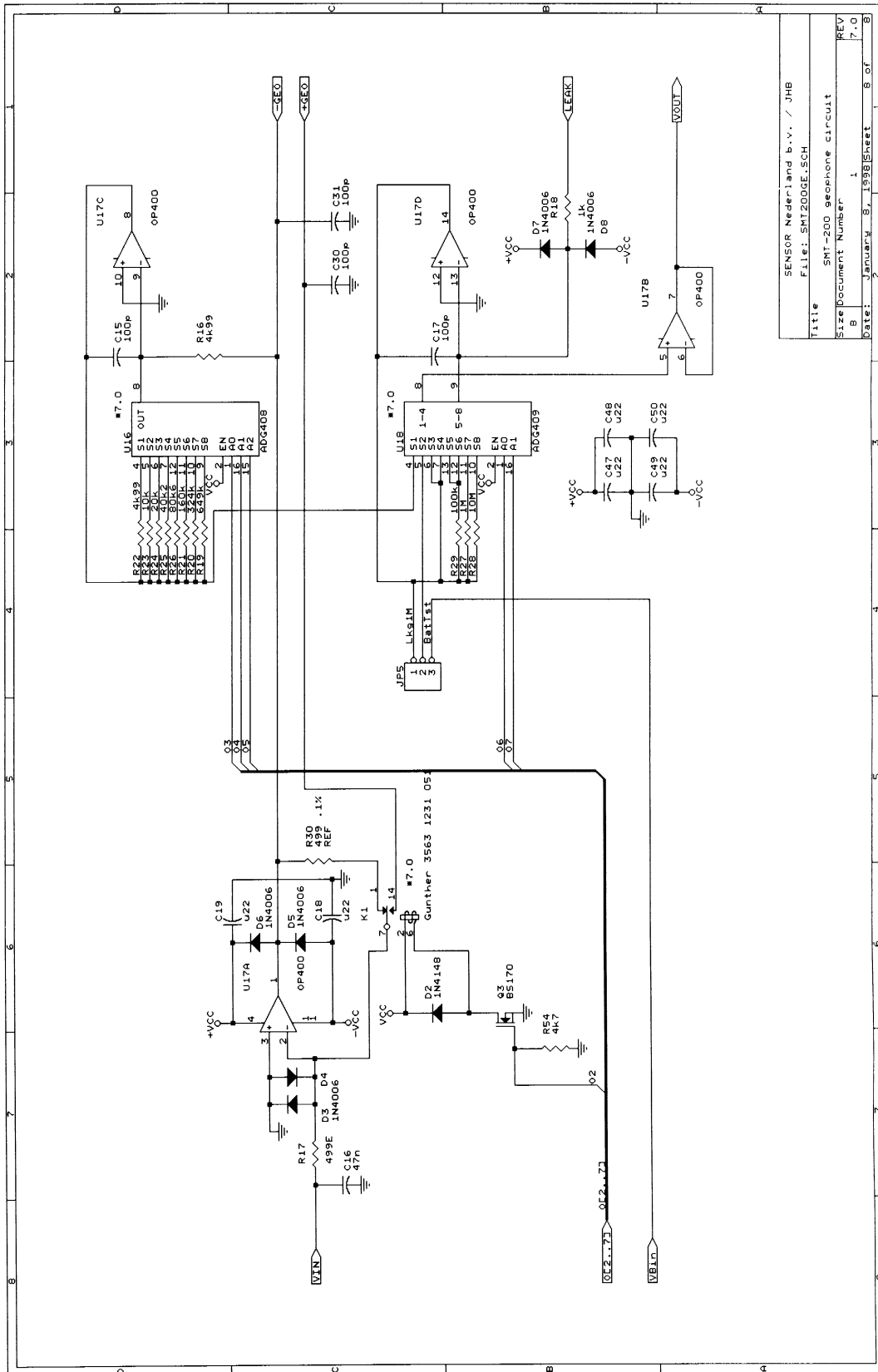



D.1.7 SMT-200 Power

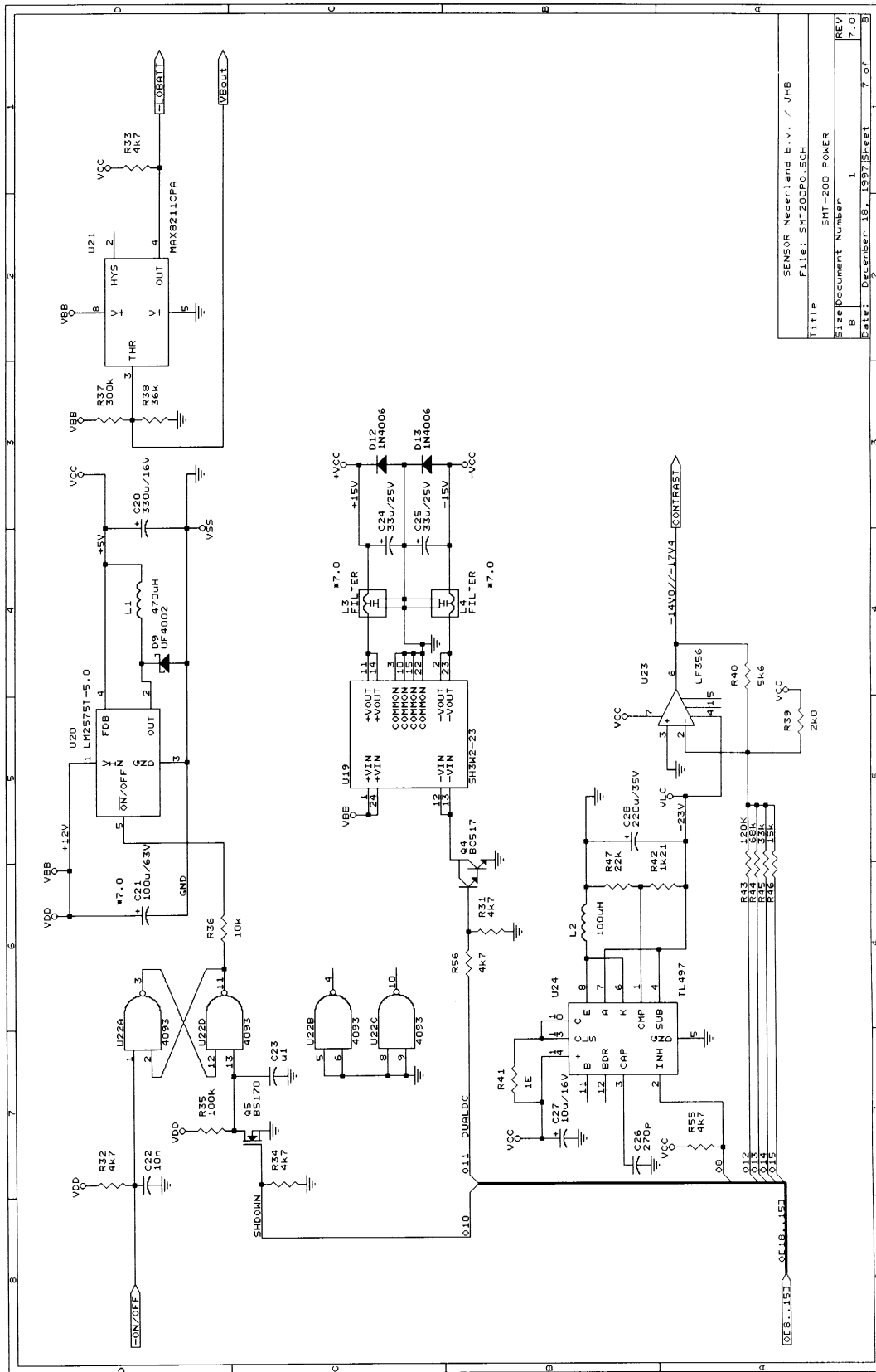

Title	SENSOR Nederland b.v. / JHB		
File	SMT200P0.SCH		
Size	SMT-200 POWER		
Document Number	1		
REV	7.0		
Date	December 18, 1997	Sheet	7 of 8

D.1.8 SMT-200 Display

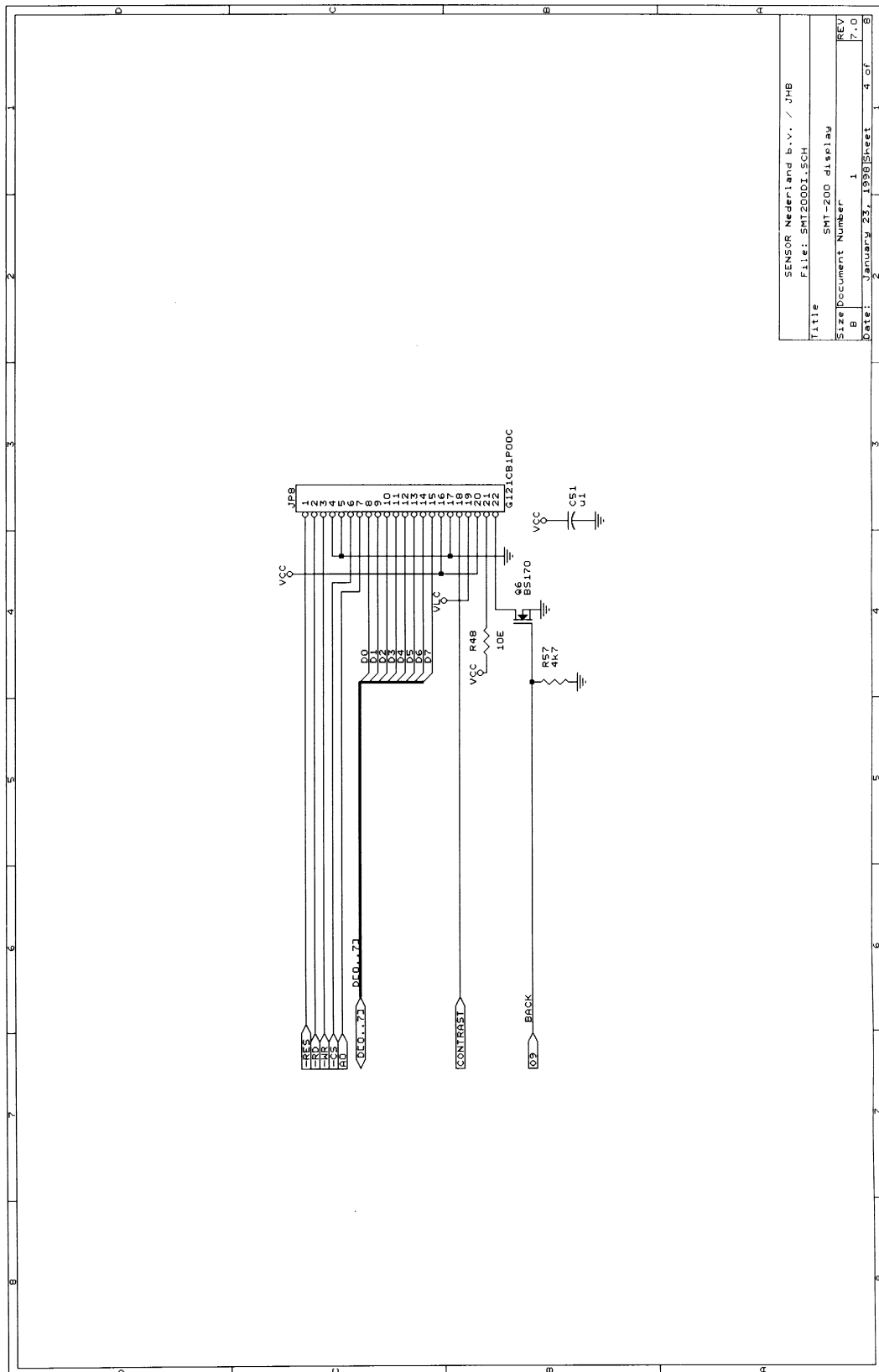



D.2 SMT-200 Component Layout (SMT-200.7 01/98)

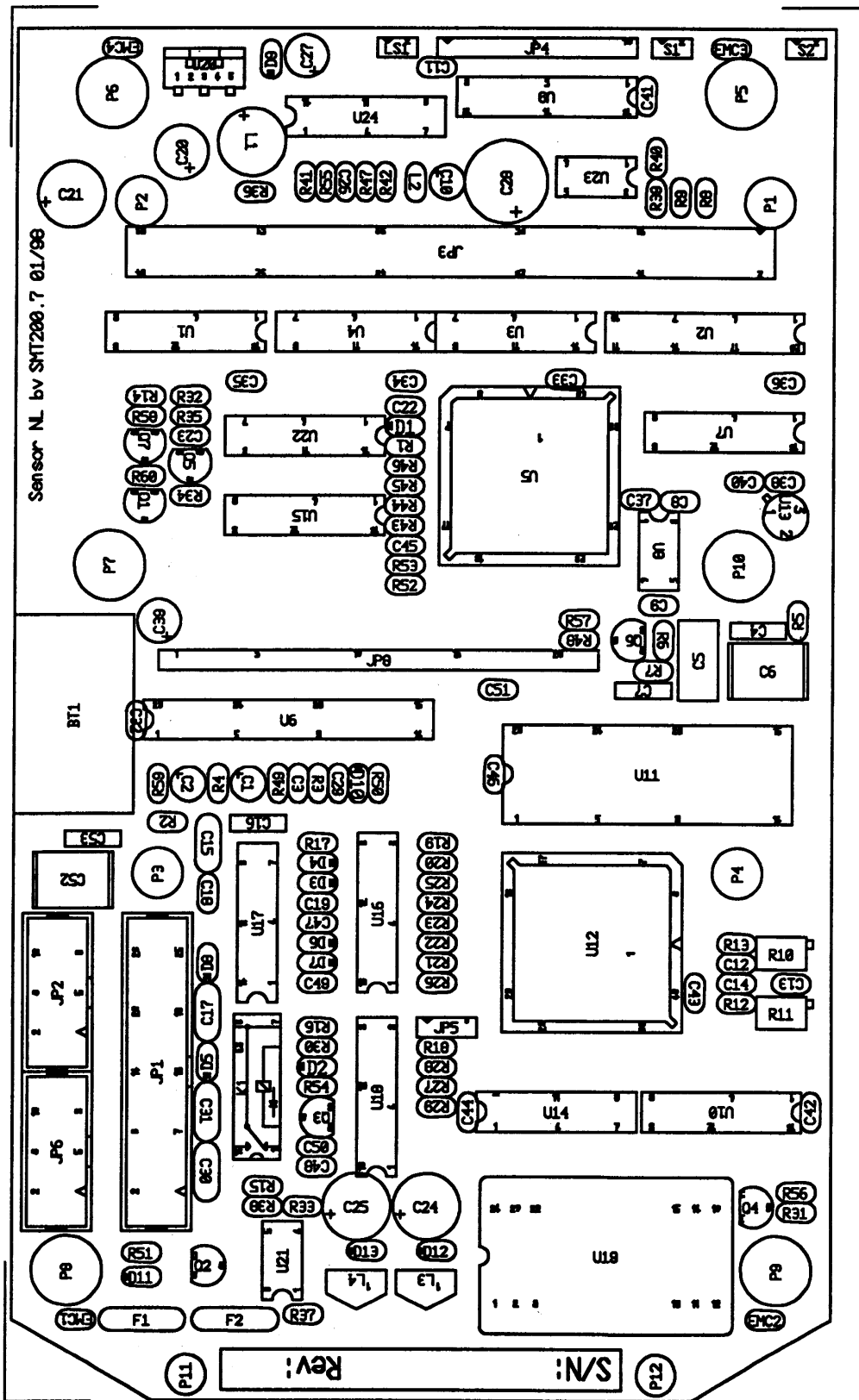

D.3 SMT-200 Docking Station Schematics

D.3.1 SMT-200 Docking Station / Charger

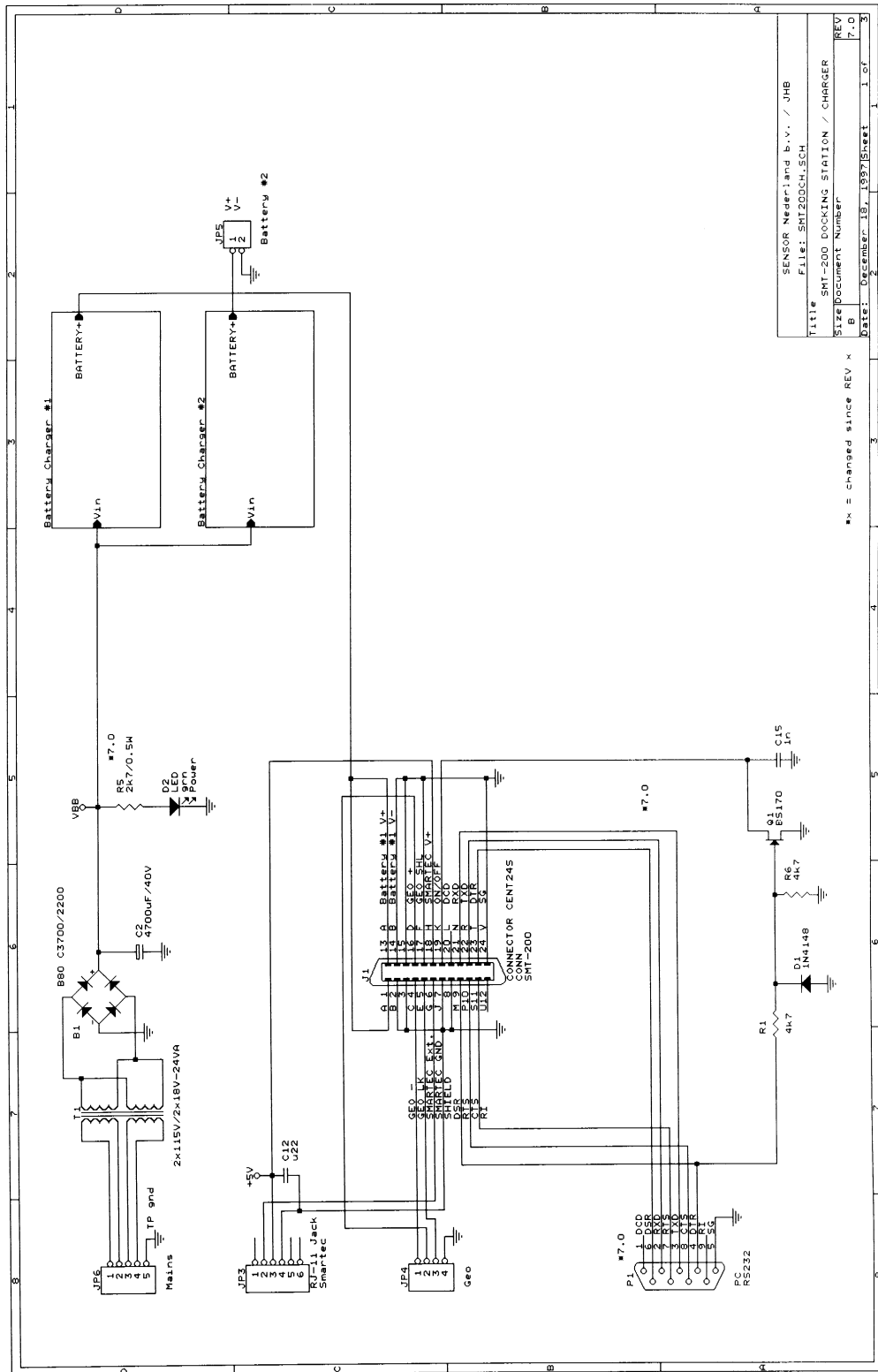



D.3.2 UC3906-B1

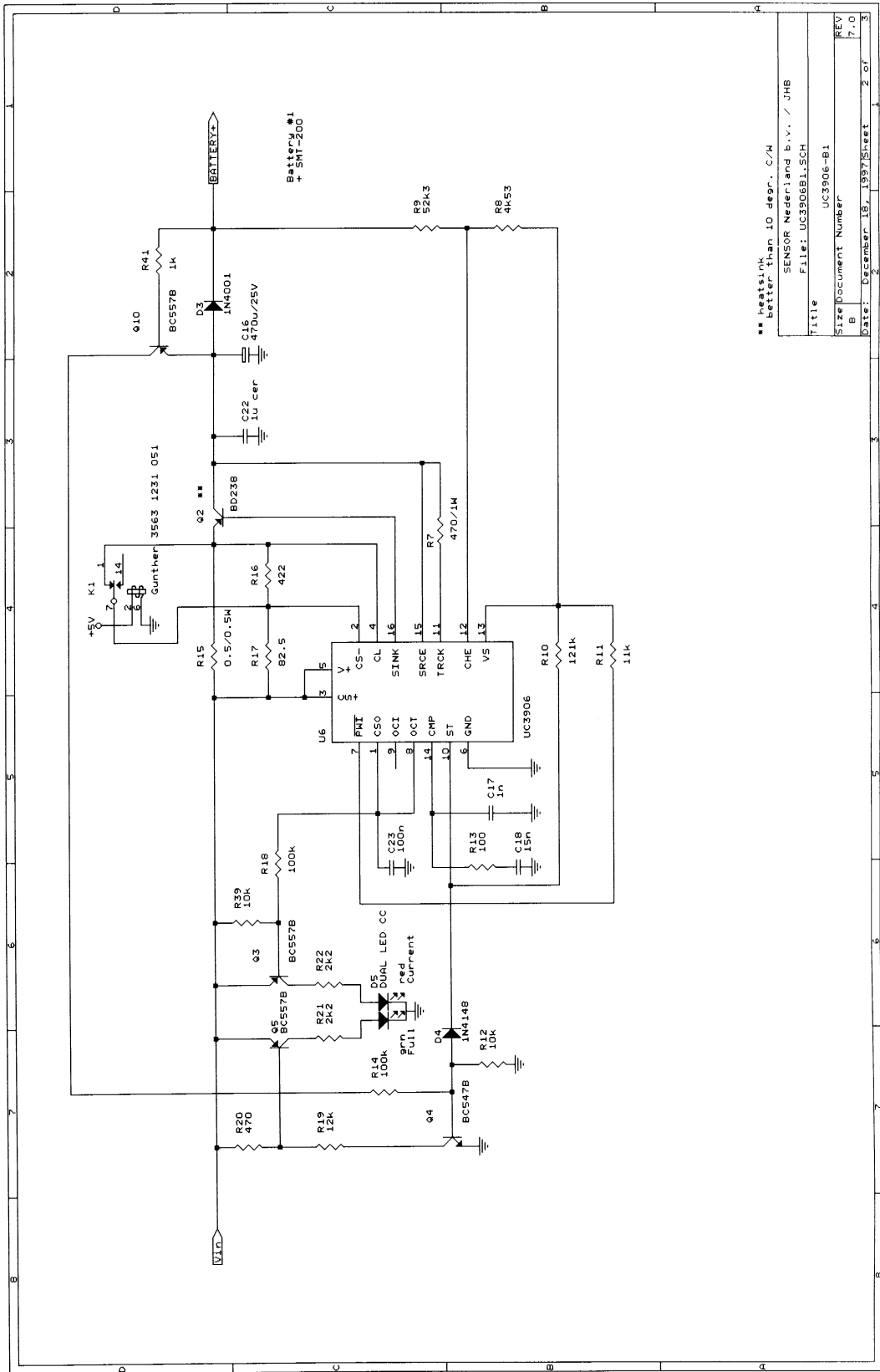

D.3.3 UC3906-B2

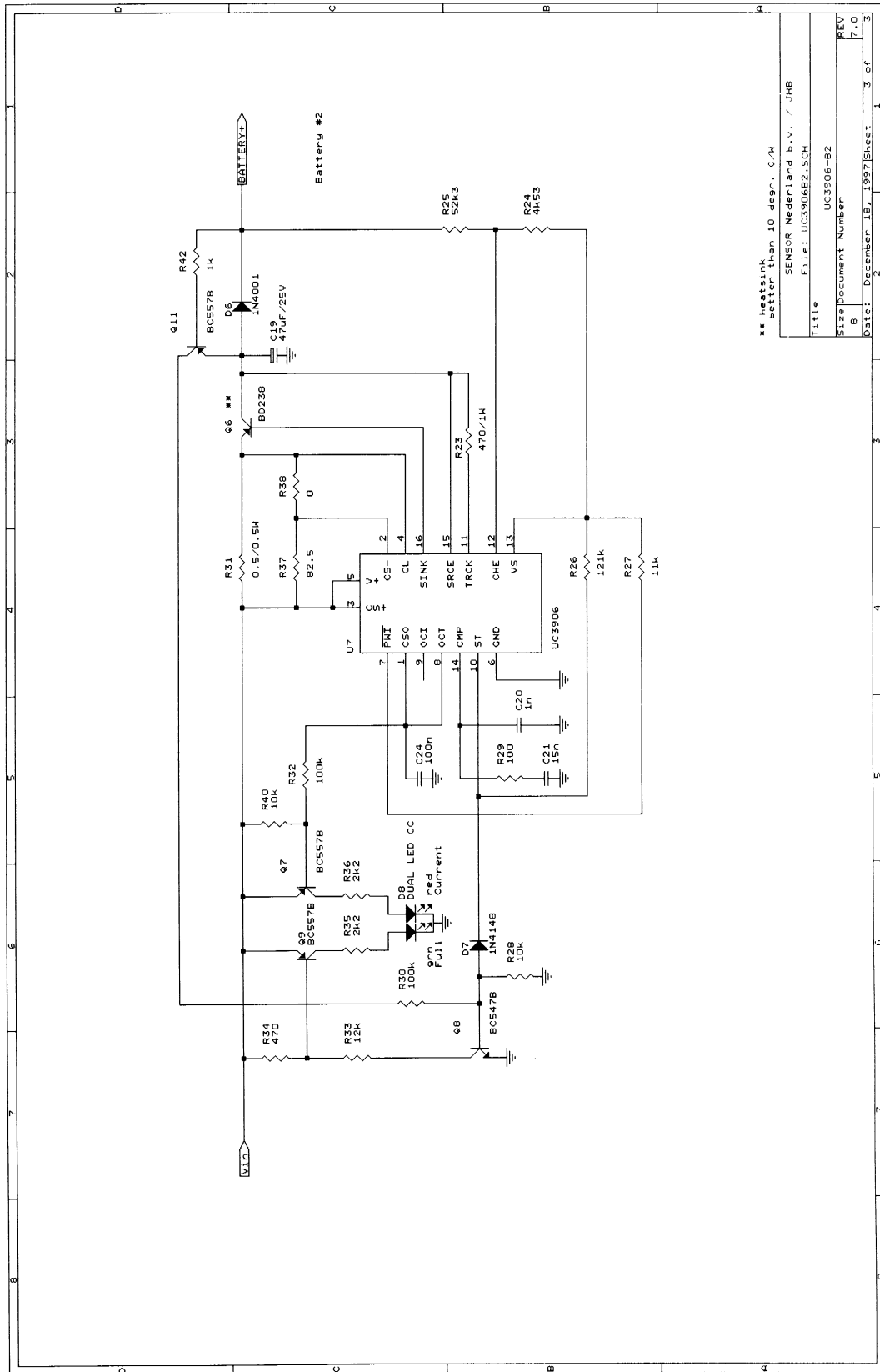

Page intentionally left blank

Appendix E

Quick Reference

Page intentionally left blank

E.1 Quick Reference

<u>Function</u>	<u>Action</u>	<u>LCD Display</u>	<u>Keys</u>				
			1	2	3	4	5
About		About	6 (or 5)				
Audible warnings	ON/off	Beeps	2	6	4		
Autonumbering	ON/off	Autonumber ON/off	2	3	1		
Configuration - Read from disk		Read Config	4	6			
Configuration - Write to disk		Save Config	4	7			
Continue test on a reject	Toggle	Cont on reject	2	3	4		
Continuous Impedance test bar graph range	Value	Bar-range	2	5	5		
Continuous mode test interval	Value	Interval	2	3	8		
Continuous test Maximum number of tests	Value	Max_Test	2	5	4		
Continuous test mode	ON/off	Continuous	2	3	7		
Data file - Dump to Com. port		Dump data file	4	3			
Data file - Erase ALL data from memory		Erase ALL data	4	5			
Data file - List contents		List data file	4	4			
Data file - Storage status		Storage status	4	2			
Date & Time		Date & Time	2	8			
Date & Time - Display & Modify	Value	Date & Time	2	8			
Diagnostics		Diagnostics	2	9			
Diagnostics - Analogue circuits test		Analogue	2	9	7	1	
Diagnostics - Attenuator settings		Attenuator	2	9	6	6	2
Diagnostics - Audible warning device test		Sound	2	9	5	5	
Diagnostics - Backlight on/off test		Backlight	2	9	5	3	
Diagnostics - Battery voltage and Lo switch point test		Battery	2	9	6	4	
Diagnostics - Display - selects display tests		Display	2	9	5		
Diagnostics - Display contrast range test		Contrast	2	9	5	4	
Diagnostics - Display pixel test		Pixels	2	9	5	2	
Diagnostics - Gain range & offset test AC		AC Gain range	2	9	7	3	
Diagnostics - Gain range & offset test DC		DC Gain range	2	9	7	4	
Diagnostics - Hardware tests		Hardware	2	9	6		
Diagnostics - Keypad button test		Keys	2	9	5	1	
Diagnostics - Leakage test		Leakage	2	9	7	5	
Diagnostics - Leakage test - Calibrate	Value	lopa	2	9	1		
Diagnostics - Noise test		Noise	2	9	7	2	
Diagnostics - Post Mortem (shows last shutdown status)		Post Mortem	2	9	3		
Diagnostics - Power up analogue circuit		DC/DC	2	9	6	6	1
Diagnostics - Ref./Geo relay contact test		Relay	2	9	6	5	
Diagnostics - Resets all tester setting to default values		Reset All	2	9	4		
Diagnostics - Serial port (RS232) communication test		Serial port	2	9	6	1	
Diagnostics - Simulation - no real test	ON/off	Simulation	2	9	2		
Diagnostics - Sine wave frequency settings		Freq.	2	9	6	6	3
Diagnostics - Sine wave generator test		Sine wave	2	9	6	6	
Diagnostics - Temperature sensor test external		Extemp	2	9	6	3	
Diagnostics - Temperature sensor test internal		InTemp	2	9	6	2	
Diagnostics - Tests		Tests	2	9	7		
Display - Backlight	ON/off	Backlight	2	6	1		
Display - Backlight on time (power saving)	Enter Value	B-Light	2	7	2		
Display - Contrast decrease	-	LCD Contrast	2	6	3		
Display - Contrast increase	+	LCD Contrast	2	6	2		



<u>Function</u>	<u>Action</u>	<u>LCD Display</u>	<u>Keys</u>				
			1	2	3	4	5
Display - On time (power saving)	Enter Value	Display	2	7	3		
Display menu		Display menu	2	6			
Erase ALL data from memory		Erase ALL data	4	5			
File menu		File menu	4				
Full test mode (display all results)	Toggle	Full test	2	3	3		
Geophone file - Copy geophone type		Copy	2	2	3		
Geophone file - Delete geophone type		Delete	2	2	4		
Geophone file - Edit geophone type	Enter Value	Edit	2	2	2		
Geophone file - Select geophone type		Select	2	2	1		
Geophone menu		Geophone menu	2	2			
Go /No Go test (display as only good or bad)	Toggle	Go /No Go Test	2	3	3		
Imperial units	Toggle	Imperial units	2	6	6		
Interval between tests in Continuous mode	Enter Value	Interval	2	3	8		
Keypad Beeps	ON/off	Key Beeps	2	6	5		
Lead-in length	Enter Value	Lead-in	2	1	6		
Leakage test reject limit	Enter Value	Leak	2	5	3		
Limits menu		Limits menu	2	5			
List contents of the data file		List data file	4	4			
Log-off time	Enter Value	Log-off	2	7	5		
Low_Drive test excitation level	Enter Value	Low_Drive	2	5	1		
Metric units	Toggle	Metric units	2	6	6		
Noise test reject limit	Enter Value	Noise	2	5	2		
Operating menu		Operating menu	2	3			
Polarity test tap sensitivity	Enter Value	Pol_Sens	2	5	6		
Power menu		Power menu	2	7			
Power savings enable	ON/off	Saving	2	7	1		
Power SMT-200 Tester On		Power Tester On	Enter / Start				
Redisplay last test results		Redisplay last	4	1			
Repeat geophone Test		Repeat Test	+/-				
Return to the main Menu		Back to main	. or 0				
Save reject tests too		Save rej's	2	3	2		
Serial Number		About...	6 (or 5)				
Setup menu		Setup menu	2				
Shunt Resistor - Enable	Yes/No	Use shunt?	2	1	7		
Shunt resistor value	Enter Value	Shunt	2	1	8		
Shut-down time (power saving)	Enter Value	Shut-down	2	7	4		
Skip rest of test on a reject	Toggle	Skip on reject	2	3	4		
Software Version		About...	6 (or 5)				
Start next geophone test	Enter	Start next Test	1	Enter/Start			
Storage status		Storage status	4	2			
String - Elements in parallel	Enter Value	Parallel	2	1	3		
String - Elements in series	Enter Value	Series	2	1	2		
String - Geophone interval	Enter Value	Interval	2	1	5		
String - Shunt resistor value	Enter Value	Shunt	2	1	8		
String - Specific cable resistance	Enter Value	Rcab	2	1	4		
String - Test number	Enter Value	No.	2	1	1		
String configuration menu		String menu	2	1			
Tag - Display tag list & test/string number		Tag list	5	2			
Tag - Read tag & allocate/display test/string number		Read tags	5	1			



<u>Function</u>	<u>Action</u>	<u>LCD Display</u>	<u>Keys</u>					
			1	2	3	4	5	
Tag menu		Tag menu	5					
Temperature - Enable Smartec	ON/off	Smartec	3	3				
Temperature - Measure Smartec Temp.		Smartec Temp.	3	4				
Temperature - Measure using Reference SM-4		Ref. Geo Temp.	3	2				
Temperature - of string		Temp.	3	1				
Temperature Correction on Data	Toggle	T-Corr on Data	2	3	6			
Temperature Correction on Specification	Toggle	T-Corr on Spec	2	3	6			
Temperature menu		Temp. menu	3					
Test - Continuous Impedance bar graph range	Enter Value	Bar_range	2	5	5			
Test - Distortion & Impedance	ON/off	Dist. Imp	2	4	7			
Test - Frequency, Damping & Sensitivity	ON/off	Fn, Bo, Go	2	4	6			
Test - Leakage	ON/off	Leakage	2	4	4			
Test - Leakage reject limit	Enter Value	Leak	2	5	3			
Test - Low Drive	ON/off	Low Drive	2	4	1			
Test - Low_Drive excitation level	Enter Value	Low_Drive	2	5	1			
Test - Maximum number of test in Cont. mode	Enter Value	Max_Test	2	5	4			
Test - Noise	ON/off	Noise	2	4	3			
Test - Noise reject limit	Enter Value	Noise	2	5	2			
Test - Polarity	ON/off	Polarity On/off	2	4	2			
Test - Polarity First	Toggle	Polarity test First	2	4	9			
Test - Polarity Last	Toggle	Polarity test Last	2	4	9			
Test - Polarity tap sensitivity	Enter Value	Pol_Sens	2	5	6			
Test - Resistance	ON/off	Resistance	2	4	5			
Test a geophone (string)		Do a test...	1					
Test Continuous Impedance	ON/off	Cont. Imp	2	4	8			
Test number	Enter Value	No.	2	1	1			
Test with a Constant Excursion	Toggle	@ Constant Exc.	2	3	5			
Test with a Constant Velocity	Toggle	@ Constant Vel.	2	3	5			
Tests Sequence		Tests Sequence	2	4				

Page intentionally left blank

Appendix F

Addendum

Page intentionally left blank

F.1 Addendum

Page intentionally left blank

Index

	@		
@Constant.....		23	
	A		
About		19, 34	
AC Gain		28	
Alt-X		41	
Analogue.....		28	
Attenuator		28	
Autonumber		23, 57	
	B		
Back Light.....		24, 25, 27	
Back to Main.....		19, 20	
Back to Setup		20	
Bad geophone		67	
Bar range		21	
Battery		27	
Battery charging		6, 38, 84	
Battery level.....		14	
Battery level - Jumper setting.....		15	
Battery Low.....		10, 26	
Battery Status monitor display.....		14	
Battery status Bar Graph Indicator		14	
BatTst		15	
Baud rate		31	
Beeps.....		24	
	C		
Cable resistance.....		20	
Coil Resistance.....		4	
Com settings.....		42	
COM settings.....		57	
Constant excursion.....		23	
Constant velocity		23	
Continue on reject		23	
Continuous		23	
Continuous impedance.....		66	
Continuous Impedance.....		24	
Contrast		27	
Copy		21, 22, 42	
Cursor control		10	
	D		
Damping		4, 19	
Data Download.....		42	
Data Exchange		43	
Data file name		42	
Data transfer sequence		43	
Date & Time.....		20, 25	
DC Gain		28	
DC/DC.....		28	
Delete.....		21, 22	
Diagnostics		20, 26	
Direct control.....		10	
Display		25, 27	
Display menu		20, 24	
Distortion		19	
Distortion Failures		68	
Distortion Impedance.....		24	
Do a test.....		19	
Docking Station interconnection		37	
Docking Station overview		37	
DOS installation		40	
DOS un-install.....		40	
Down/Upload		55, 58	
Downloading data to PC		64	
DTR.....		31	
Dump data file.....		30, 31	
Dynamic Resistance		4	
	E		
Edit.....		21, 22	
Environmental Specifications.....		5	
Erase.....		42	
Erase data.....		30, 32	
Estimated Space.....		19	
Excursion		23	
External Temp.....		27	
	F		
F1.....		41	
F10.....		41	
Failing System Updates		45	
Failing Transfers		44	
File		52	
File menu		19, 30, 42	
File Transfer.....		42, 43, 44	
Fn, Bo, Go.....		24	
Frequency.....		19, 28	
Frequency, Damping and Sensitivity Failures		68	
Full Test		23	
Function keys.....		41	
	G		
Geophone menu		20, 21, 61	
Geophone Specifications File		45	
	H		
Hardware		27	
Harmonic Distortion		4	

I		Power On Self Tests..... 9
Impedance..... 19		Print..... 42
Impedance Failures..... 69		
Imperial Units..... 24		R
Internal storage..... 58		R-Cab..... 20
Internal Temperature..... 27		Read Config..... 33
Interval..... 20, 23		Read Configuration..... 30
lopa..... 26		Read tags..... 50
Isolation Table..... 69		Redisplay Last..... 30
		Reference Geophone Temperature..... 29
J		Reject codes..... 65
JP5..... 15		Relay..... 27
		Repeat Test..... 19
K		Reset all..... 26
Key Beeps..... 24		Resistance..... 19, 24
Key-hanger..... 49		Resistance Failures..... 68
Keys..... 27		Retrieve configuration..... 42
		RFID Tag reader..... 49
L		
LCD Contrast..... 24		S
LCD Contrast+..... 24		Save Config..... 33
Lead-in..... 20		Save Configuration..... 30
Leakage..... 19, 21, 24, 28		Save Rejects..... 23
Leakage Test..... 5		Savings..... 25
Limits menu..... 20, 21		Select..... 21
List data file..... 30, 32		Select menu..... 22
Log-Off..... 25		Sensitivity..... 4, 19
Low Drive..... 21, 24		Serial port..... 27
		Series..... 19, 20
M		Setup menu..... 19, 20, 61
Max Test..... 21		Shunt..... 19, 20
Menu flowchart..... 16		Shut Down..... 19
Metric Units..... 24		Shut Down Error..... 10, 26
		Shut-Down..... 25
N		Simulation..... 26
Name..... 56		Sine wave..... 27, 28
Natural Frequency..... 4		Smartec..... 29
Newspec#..... 22		Smartec Temperature..... 29
Noise..... 21, 24, 28		SMT-200 menu..... 42
Normal Shut Down..... 26		SMT-200DS menu..... 42
Number..... 19		Software installation..... 39
		Sound..... 27
O		Start..... 19
Operating menu..... 20, 23, 62		Start next test..... 19
		Storage status..... 30, 31
P		String menu..... 20
Parallel..... 19, 20		Switching off the SMT-200..... 13
PC Interface..... 38		Switching on the SMT-200..... 9
PC/104..... 73		System Update..... 42, 45
Physical Characteristics..... 5		
PIN..... 26		T
Pixels..... 27		Tab..... 41
Polarity..... 19, 24		Tag file upload..... 42
Polarity Sensitivity..... 21		Tag list..... 50
Post Mortem..... 10, 26		Tag list downloading to PC..... 53
Power menu..... 20, 25		Tag list sorting..... 53
		Tag menu..... 19, 50
		Tag menu visible..... 57
		Tag Number..... 52

Tagfile upload	53
Temp. menu	19, 28
Temperature	19, 29
Temperature correction	23
Temperature Correction	23
Temperature High.....	10, 26
Temperature Low	10, 26
Test codes	65
Test number	20
Test Sequence	20
Test Storage	5
Testing strings	51, 63
Tests	28
Tests Sequence.....	24
Timed Out.....	26
Transfer data file.....	52
Troubleshooting.....	66

U

Use Shunt	20
-----------------	----

V

Velocity	23
View	42
View File	52
View tag list on PC.....	55
View tag list on SMT-200.....	55
Voltage selection.....	6

W

Windows installation	39
Windows un-install	40

Notes



Notes: