



**G-882 CESIUM MARINE  
MAGNETOMETER**  
25919-OM REV. D

*Operation Manual*

COPYRIGHT © 2005

**GEOMETRICS, INC.**

2190 Fortune Drive, San Jose, California 95131 USA

Phone: (408) 954-0522

Fax: (408) 954-0902

email: [sales@mail.geometrics.com](mailto:sales@mail.geometrics.com)



# CE

# 03

March 14, 2003  
Sunnyvale, California, USA

## EC DECLARATION OF CONFORMITY

We, Geometrics, Inc.  
Geometrics Europe  
2190 Fortune Drive  
San Jose, CA 95131 USA  
ph: (408) 734-4616  
FAX: (408) 745-6131

declare under our sole responsibility that our marine magnetometers, models G-880, G-881 and G-882 to which this declaration relates are in conformity with the following standards:

EN 55022: 1995, EN50082-2 : 1995, ENV 50140: 1994, ENV 50141 : 1994, EN 61000-4-2: 1995, EN 61000-4-4: 1995

per the provisions of the **Electromagnetic Compatibility Directive 89/336/EEC** of May 1989 as Amended by *92/31/EEC* of 28 April 1992 and *93/68-EEC, Article 5* of 22 July 1993.

The Technical documentation required by Annex IV(3) of the Low Voltage Directive is maintained by Christopher Leech of Geometrics Europe (address below).

The authorized representative located within the Community is:

Geometrics Europe  
Christopher Leech  
Manor Farm Cottage  
Galley Lane  
Great Brickhill  
Bucks.MK17 9AB, U.K.  
ph: +44 1525 261874  
FAX: +44 1525 261867

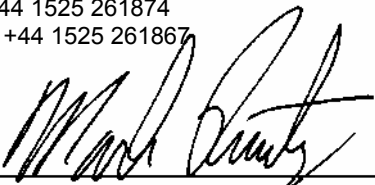

Mark Prouty, President  
San Jose, CA, USA

**Warning**

**This is a Class A product. In a domestic environment this product may cause radio interference in which case the user may be required to take adequate measures.**



**GEOMETRICS**

## **G-882 MARINE MAGNETOMETER**

- **CESIUM VAPOR HIGH PERFORMANCE** – Highest detection range and probability of detecting all sized ferrous targets
- **NEW STREAMLINED DESIGN FOR TOW SAFETY** – Low probability of fouling in lines or rocks
- **NEW QUICK CONVERSION FROM NOSE TOW TO CG TOW** – Simply remove an aluminum locking pin, move tow point and reinsert. New built in easy carry handle!
- **NEW INTERNAL CM-221 COUNTER MODULE** – Provides Flash Memory for storage of default parameters set by user
- **NEW ECHOSOUNDER / ALTIMETER OPTION**
- **NEW DEPTH RATING** – 4,000 psi !
- **HIGHEST SENSITIVITY IN THE INDUSTRY** – 0.004 nT/Hz RMS with the internal CM-221 Mini-Counter
- **EASY PORTABILITY & HANDLING** – no winch required- single man operation, 44 lbs with 200 ft cable (without weights or depressor wing)
- **COMBINE TWO SYSTEMS FOR INCREASED COVERAGE** – Internal CM-221 Mini-Counter provides multi-sensor data concatenation allowing side by side coverage which maximizes detection of small targets and reduces noise



**G-882 with Weight Collar  
Depth Option & Altimeter**

Very high resolution Cesium Vapor performance is now available in a low cost, small size system for professional surveys in shallow or deep water. High sensitivity and sample rates are maintained for all applications. The well proven Cesium sensor is combined with a unique new CM-221 Larmor counter and ruggedly packaged for small or large boat operation. Use your computer and standard printer with our MagLog Lite™ software to log, display and print GPS position and magnetic field data. The G-882 is the lowest priced high performance full range marine magnetometer system ever offered.

The G-882 is flexible for operation in small boat, shallow water surveys as well as deep tow applications (4,000 psi rating, telemetry over steel coax available to 10Km). Being small and lightweight (40 lbs net, no extra weights) it is easily

deployed and operated by one person. But add several streamlined weight collars and the system can quickly weigh more than 100 lbs. Power may be supplied from a 24 to 30 VDC battery power or the included 110/220 VAC power supply. The tow cable employs high strength Kevlar with a standard length of 200 ft (61 m) and optional cable length up to 500m (no telemetry required). A rugged fiber-wound fiberglass housing provides selectable orientation of the sensor and therefore maintains operations throughout the world with only small limitations as to direction of survey in equatorial regions. The shipboard end of the tow cable is attached to an included junction box or optional on-board cable for quick and simple hookup to power and output of data into any Windows 98, ME, NT, 2000 or XP computer equipped with RS-232 serial ports.

The G-882 Cesium magnetometer provides the same operating sensitivity and sample rates as the larger deep tow model G-880. MagLogLite™ Logging Software is offered with each magnetometer and allows recording and display of data and position with Automatic Anomaly Detection! Additional options include: MagMap2000 plotting and contouring software and post acquisition processing software MagPick™ (free from our website.)

The G-882 system is particularly well suited for the detection and mapping of all sizes of ferrous objects. This includes anchors, chains, cables, pipelines, ballast stone and other scattered shipwreck debris, munitions of all sizes (UXO), aircraft, engines and any other object with magnetic expression. Objects as small as a 5 inch screwdriver are readily detected provided that the sensor is close to the seafloor and within practical detection range. (Refer to table at right).

The design of this high sensitivity G-882 marine unit is directed toward the largest number of user needs. It is

intended to meet all marine requirements such as shallow survey, deep tow through long cables, integration with Side Scan Sonar systems and monitoring of fish depth and altitude.

Typical Detection Range For Common Objects

|                          |                                   |
|--------------------------|-----------------------------------|
| Ship 1000 tons           | 0.5 to 1 nT at 800 ft (244 m)     |
| Anchor 20 tons           | 0.8 to 1.25 nT at 400 ft (120 m)  |
| <u>Automobile</u>        | <u>1 to 2 nT at 100 ft (30 m)</u> |
| Light Aircraft           | 0.5 to 2 nT at 40 ft (12 m)       |
| Pipeline (12 inch)       | 1 to 2 nT at 200 ft (60 m)        |
| <u>Pipeline (6 inch)</u> | <u>1 to 2 nT at 100 ft (30 m)</u> |
| 100 KG of iron           | 1 to 2 nT at 50 ft (15 m)         |
| 100 lbs of iron          | 0.5 to 1 nT at 30 ft (9 m)        |
| 10 lbs of iron           | 0.5 to 1 nT at 20 ft (6 m)        |
| 1 lb of iron             | 0.5 to 1 nT at 10 ft (3 m)        |
| Screwdriver 5 inch       | 0.5 to 2 nT at 12 ft (4 m)        |
| <u>1000 lb bomb</u>      | <u>1 to 5 nT at 100 ft (30 m)</u> |
| 500 lb bomb              | 0.5 to 5 nT at 50 ft (16 m)       |
| Grenade                  | 0.5 to 2 nT at 10 ft (3 m)        |
| 20 mm shell              | 0.5 to 2 nT at 5 ft (1.8 m)       |

**MODEL G-882 CESIUM MARINE MAGNETOMETER SYSTEM SPECIFICATIONS**

|                                    |   |
|------------------------------------|---|
| <b>OPERATING PRINCIPLE:</b>        | Self-oscillating split-beam Cesium Vapor (non-radioactive)  |
| <b>OPERATING RANGE:</b>            | 20,000 to 100,000 nT  |
| <b>OPERATING ZONES:</b>            | The earth's field vector should be at an angle greater than 6E from the sensor's equator and greater than 6E away from the sensor's long axis. Automatic hemisphere switching is standard.                                      |
| <b>CM-221 COUNTER SENSITIVITY:</b> | <0.004 nT/ πHz rms. Up to 10 samples per second   |
| <b>HEADING ERROR:</b>              | √1 nT (over entire 360E equatorial and polar spin )   |
| <b>ABSOLUTE ACCURACY:</b>          | <3 nT throughout range  |
| <b>OUTPUT:</b>                     | RS-232 at 1,200 to 19,200 Baud  |
| <b>MECHANICAL:</b>                 |   |
| Sensor Fish:                       | Body 2.75 in. (7 cm) dia., 4.5 ft (1.37 m) long with fin assembly (11 in. cross width), 40 lbs. (18 kg) Includes Sensor and Electronics and 1 main weight. Additional collar weights are 14lbs (6.4kg) each, total of 5 capable |
| Tow Cable:                         | Kevlar Reinforced multiconductor tow cable. Breaking strength 3,600 lbs, 0.48 in OD, 200 ft maximum. Weighs 17 lbs (7.7 kg) with terminations.  |
| <b>OPERATING TEMPERATURE:</b>      | -30EF to +122EF (-35EC to +50EC)  |
| <b>STORAGE TEMPERATURE:</b>        | -48EF to +158EF (-45EC to +70EC)  |
| <b>ALTITUDE:</b>                   | Up to 30,000 ft (9,000 m)   |
| <b>WATER TIGHT:</b>                | O-Ring sealed for up to 9000 ft (2750 m) depth operation  |
| <b>POWER:</b>                      | 24 to 32 VDC, 0.75 amp at turn-on and 0.5 amp thereafter  |
| <b>ACCESSORIES:</b>                |   |
| Standard:                          | View201 Utility Software operation manual and ship kit  |
| Optional:                          | Telemetry to 10Km coax, gradiometer (longitudinal or transverse), reusable shipping case  |
| MagLog Lite™ Software:             | Logs, displays and prints Mag and GPS data at 10 Hz sample rate. Automatic anomaly detection and single sheet Windows printer support   |

**SPECIFICATIONS SUBJECT TO CHANGE WITHOUT NOTICE**



**GEOMETRICS, INC.** 2190 Fortune Drive, San Jose, California 95131  
 Tel: 408-954-0522 Fax 408-954-0902 Email: sales@mail.geometrics.com

**GEOMETRICS Europe** Manor Farm Cottage, Galley Lane, Great Brickhill, Bucks,  
 England MK179AB 44-1525-261874 Fax 44-1525-261867

**GEOMETRICS China**

Laurel Industrial Co. Inc. - Beijing Office, Room 2509-2511, Full Link Plaza  
#18 Chaoyangmenwai Dajie, Chaoyang District, Beijing, China 100020  
10-6588-1126 (1127..1130), 10-6588-1132 Fax 010-6588-1162

# Table of Contents

|            |   |           |
|------------|---|-----------|
| <b>1.0</b> | <b>Introduction .....</b>   | <b>1</b>  |
| 1.1        | How it Works .....  | 2         |
| <b>2.0</b> | <b>Quick Start Hardware Guide .....</b>   | <b>2</b>  |
| 2.1        | Nose Tow Configuration .....  | 4         |
| 2.2        | Converting Nose Tow to CG Tow .....   | 8         |
| 2.3        | Adjusting Handle And Orientation Weight .....   | 10        |
| 2.4        | Attaching the Tow Cable to the Vessel .....   | 10        |
| 2.4        | Attaching the Tow Cable to the Vessel .....   | 11        |
| 2.5        | Powering Up the System .....  | 11        |
| <b>3.0</b> | <b>Quick Start Software Guide .....</b>   | <b>12</b> |
| 3.1        | What Does MagLog Do? .....  | 14        |
| 3.2        | The Survey Wizard .....   | 15        |
| <b>4.0</b> | <b>General Overview .....</b>   | <b>25</b> |
| 4.1        | Operation and FAQ .....   | 25        |
| 4.2        | Performance .....   | 28        |
| 4.3        | Sensor Orientation Guide .....  | 29        |
| 4.3.2      | Main Field Inclination and Total Intensity Maps .....   | 33        |
| 4.4        | CM-221 Counter Data Format and Command Structure .....  | 36        |
| 4.4.1      | Output Format .....   | 36        |
| 4.4.2      | General Command instructions .....  | 39        |
| 4.4.3      | G-882 Quick Command list .....  | 40        |
| 4.4.4      | G-882 Detailed Commands .....   | 41        |
| 4.4.5      | Update Default Parameters .....   | 44        |
| 4.4.6      | Command Set Descriptions .....  | 46        |
| 4.4.7      | Power-up Initialization .....   | 54        |
| 4.5        | Accessory Software .....  | 55        |
| 4.5.1      | Cesium Sensor Active Zones – CSAZ .....   | 55        |
|            | A newly designed CSAZ Windows™ program is available on our Magnetometer CD and from our FTP site at <a href="ftp://geom.geometrics.com/pub/mag/Software/">ftp://geom.geometrics.com/pub/mag/Software/</a> (look for csaz-setup.exe). Please read the manual that is included with the program for complete instructions on how to use the CSAZ program for worldwide inclination and sensor orientation solutions. .... | 55        |
| 4.5.2      | CM201 .....   | 55        |
| 4.5.4      | Depth Cal .....   | 63        |
| 4.5.5      | Depth Calibration Using MagLog-Lite™ or MagLog™ .....   | 67        |



|            |  |            |
|------------|--|------------|
| <b>4.6</b> | <b>Assembly, Installation and Use .....</b>  | <b>72</b>  |
| 4.6.1      | Assembly of the Sensor Fish .....  | 72         |
| 4.6.2      | Installation of the G-882 Magnetometer .....   | 72         |
| 4.6.3      | Deployment of the G-882 Magnetometer.....  | 73         |
| <b>5.0</b> | <b>Service Information and Trouble Shooting Guide .....</b>                                      | <b>80</b>  |
| 5.1        | Connector Information .....  | 80         |
| 5.2        | O-ring Maintenance .....   | 82         |
| 5.3        | Depth Sensor Ratings .....   | 83         |
| 5.4        | Tow Cable Strength Data .....  | 83         |
| 5.5        | Trouble Shooting Guide .....   | 84         |
| 5.6        | The Diagnostic Survey – How to use it.....   | 88         |
|            | Final MagLog screen will look as above to provide diagnostics for system<br>troubleshooting..... | 95         |
| 5.7        | Voltage Calibration for Magnetometers using CM-221 Counters.....                                 | 95         |
|            | <b>Appendix A – Optically Pumped Magnetometer Theory.....</b>                                    | <b>103</b> |
|            | <b>Appendix B – System Connection Wiring Diagrams .....</b>                                      | <b>106</b> |
|            | <b>Appendix C: G-882 With Larmor Output .....</b>  | <b>110</b> |

This page intentionally left blank.

# 1.0 Introduction

The G-882 Marine Magnetometer has been designed and manufactured to make it easy to use and to get great marine magnetometer data. The purpose of this manual is to give new users start up information and experienced users reference information.

We begin with an introductory overview on to how the system works and then provide a Quick Start Hardware Guide to show you how to connect the magnetometer fish and tow cable system. The G-882 offers field convertible nose tow or CG (center of gravity tow) configurations and we explain how to convert one to the other. In general the nose tow is used in shallower applications, the CG tow for deeper tow requirements.

We continue with a description of the Kellems grip cable attachment system and how it is used to safely attach your tow system to a secure point on your vessel or towing winch. The Quick Start Hardware Guide concludes with a section on connecting the tow cable (or on-board deck cable) to the power-data-junction box, power supply and PC computer for data logging

Most G-882 magnetometers are supplied with our MagLog or MagLogLite software which runs on a Windows™ PC. A [Quick Start Software Guide](#) walks you through the basic setup using the MagLog Survey Wizard to configure logging of the magnetometer, GPS and printer. We suggest that the user refer to the MagLog / MagLogLite manual for more in-depth setup and operational information after using the Quick Start Guide.

Your data may be processed in our accessory software MagMap2000 and MagPick programs, also supplied with the magnetometer. Please review those manuals for processing steps and map making. The manuals are part of the software installation and can be found under the Help tab.

After the Quick Start Guides we offer the main part of the manual where we discuss deployment scenarios, tow depths, sensor orientation requirements, digital data transmission formats, troubleshooting and service information.

We have produced this manual to provide you with a basic understanding of the procedures required to obtain the best survey data obtainable and give you some tips on how to care for your magnetometer system. It is not meant to be exhaustive for every case as there are many different situations and applications in which the magnetometers can be used. As always, we are here to support you and help you get the most out of your system, so we encourage you to call or email us with questions.

Contact information:

Technical [support@mail.geometrics.com](mailto:support@mail.geometrics.com)

Sales [sales@mail.geometrics.com](mailto:sales@mail.geometrics.com)

Tel: 408-954-0522

Fax: 408-954-0902

## 1.1 How it Works

The G-882 magnetometer employs an optically pumped Cesium-vapor atomic resonance system that functions as the frequency control element in an oscillator circuit. The frequency of the magnetometer's electrical oscillator is known as the Larmor frequency. In Appendix A we give a more complete description of the internal working of the sensor, but here it suffices to say that this oscillation varies with the external ambient magnetic field. We measure those variations and send them to a computer for display and recording.

Where there are materials that have iron in them (like cables, pipelines, different types of rock, small artifacts like nails or big items like a steel ship) the earth's field distorts about the object and the cesium magnetometer sees this distortion as an increase or decrease in earth's field intensity. In the northern hemisphere, we will typically see an "anomaly" over a ferrous object which presents dipole structure with a magnetic high to the south of the object and a magnetic low to the north. This phenomenon is fully described in our Applications Manual for Portable Magnetometers (AMPM) which is available on the Magnetometer CD that comes with the system. It is also available on our website ([www.geometrics.com](http://www.geometrics.com)).

The very high sensitivity of the cesium magnetometer allows it to detect small targets at quite large distances. For localized objects, the magnetometer can sense anomalies of 1 ton (1000 kgs) of iron or steel at 100 feet (30m) or more, 250 lbs (100kgs) at 50 ft (15m) and 30 lbs (15kgs) at 25 feet (10m) or more depending on the background magnetic noise level of the earth.

Survey design is crucial to generating a data set that gives you the answers you want. In general the height of the magnetometer above the sea floor must be controlled to enable detection of the survey objective. Survey line spacing should be approximately equal to twice the detection distance to the search object for 100% coverage. The AMPM manual will give additional information on survey design for different applications such geological survey and object location. In addition, we are available to consult with you via phone or email to help you design your survey for maximum productivity.

## 2.0 Quick Start Hardware Guide

The information in this and the following section is provided to help you get the magnetometer set up and running quickly and ensure that it is working properly. It can be used prior to any survey as a system check-out.

The cesium-vapor sensor is located inside the magnetometer pressure vessel and is situated at back of the tow fish in the cylindrical body that forms a "T" with the long axis of the vessel. (see figure #1). The sensor is internally connected to the sensor-driver electronics and Larmor frequency counter circuit module

located in the front end of the pressure vessel. External electrical connection to the sensor-driver module is made at the front bulkhead through a wet-mateable 8 pin connector.

It is important that the magnetometer fish be kept clean and free from magnetic contamination (iron or steel particles, rust). Never replace any hardware that has not been checked first for magnetic effect. We encourage you to use the tools supplied with the magnetometer to minimize magnetic contamination of the fish parts.

Begin by removing the sensor, tow cable, on-board deck cable (if purchased), white junction box, power supply and software CD from the shipping crate. Have your computer on hand for later software installation and system test.



**Figure 1 G-882 Tow Fish with nose mounted echo-sounder altimeter housing**

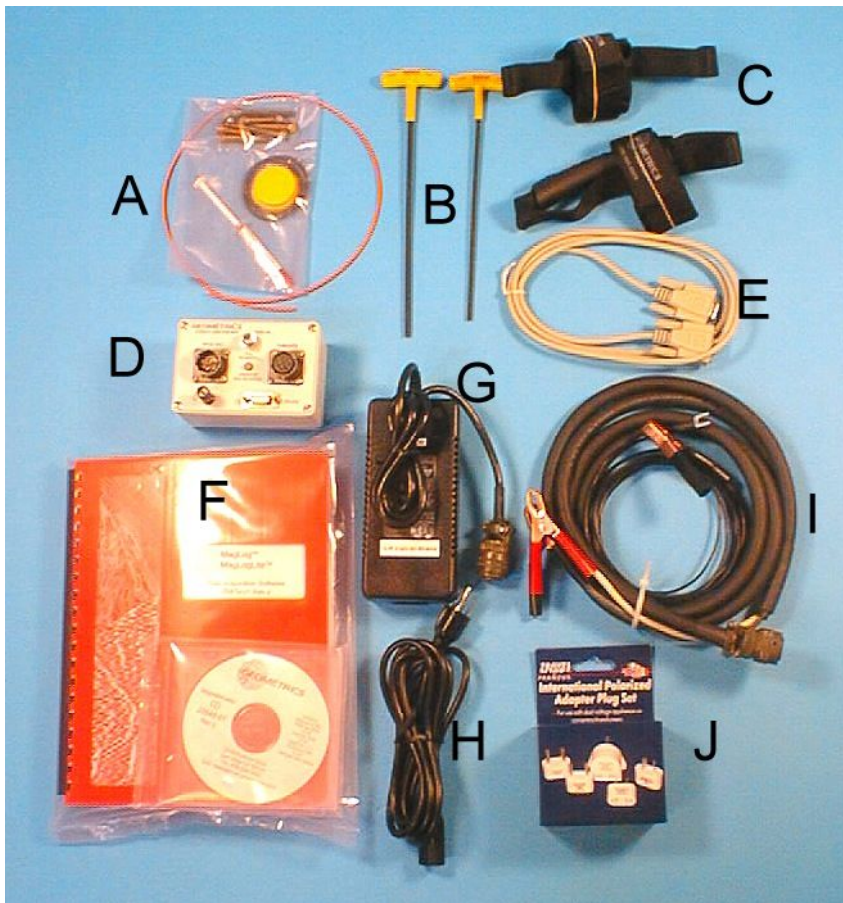

**Figure 2 Accessory Kit**

Fig 2 Accessory Kit: includes  
**A)** O-Rings, silicone grease, non-magnetic brass screws, anti-seize compound in a plastic bag with trimmer string (to lock nose to body)  
**B)** Allen wrench set  
**C)** Cable tote ties  
**D)** Junction box  
**E)** RS-232 cable  
**F)** MagLog Manual w/ software disk  
**G)** AC/DC power supply  
**H)** AC power cord  
**I)** DC power cord (with battery clips)  
**J)** Franzus international AC adapter plug kit.



**Figure 3 Tow Cable Assembly, 200 foot (60m)**

Set the magnetometer on a clean dry surface and unroll a 15 ft (5m) section of the tow cable and bring it to the nose of the fish.

## **2.1 Nose Tow Configuration**

The G-882 may be towed in either nose tow or CG (center of gravity) tow configurations. Nose tow is used in shallow water deployment (or attachment to a Side Scan Sonar). CG configuration is more commonly used when going deeper in the water column. We will discuss depth estimates later in section 4.6.3

In order to attach the tow cable to the front of the magnetometer the nose plug must be removed from the front of the nose piece. Begin by removing the top cover split-rings and linchpins and remove the top cover (Figure 4A to 4C below).

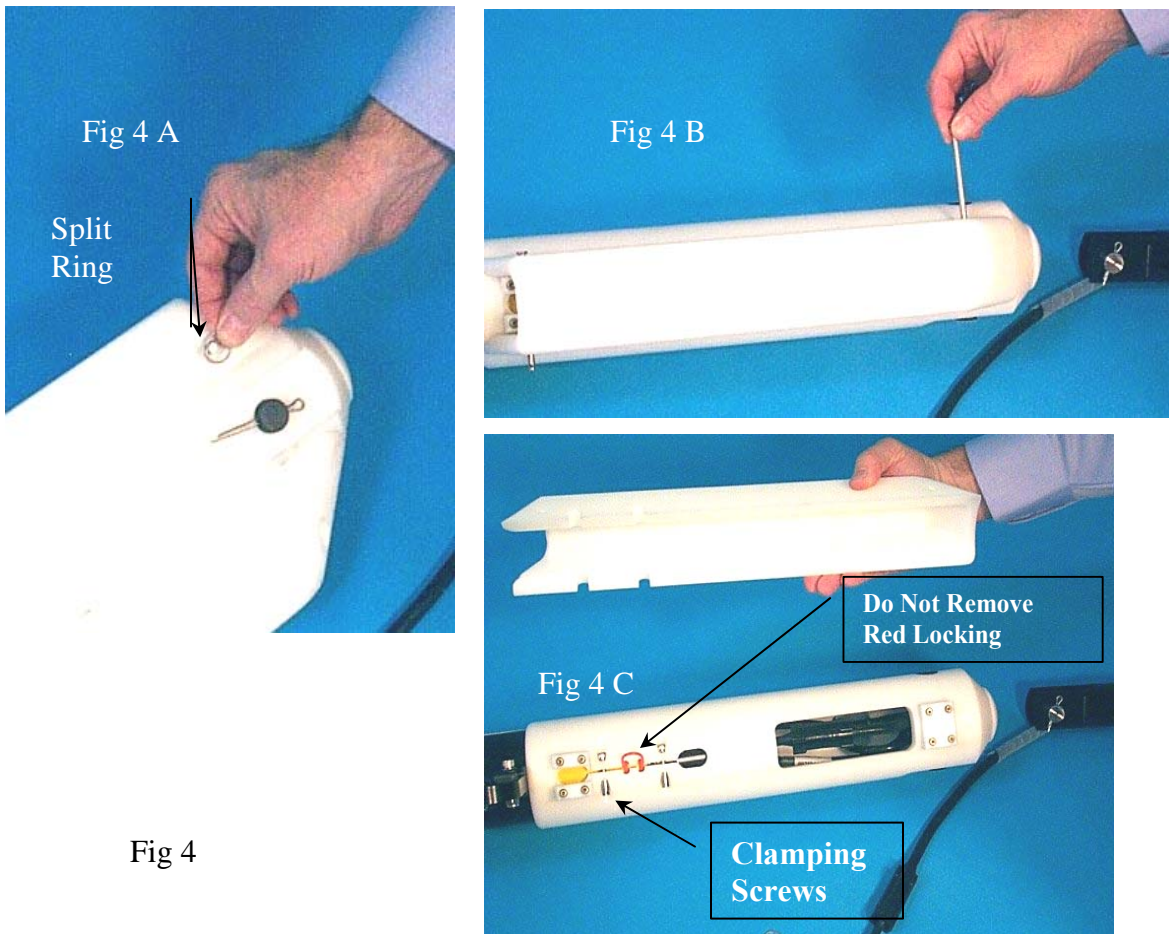

Fig 4

Note the red locking strings and nose clamping screws at the rear of the nose piece in Fig 4C. Should you need to rotate the sensor tube (discussed under sensor orientation) you will loosen these screws and rotate the nose piece and weight relative to the sensor axis at the rear. ***Never remove the red locking strings unless you need to replace the nose piece.***

Next remove the nose plug cotter pin, black clevis pin and nose plug from the nose assembly as shown in Fig 5 A to C. Store these parts in a safe place as you will need them when you convert to CG tow configuration.

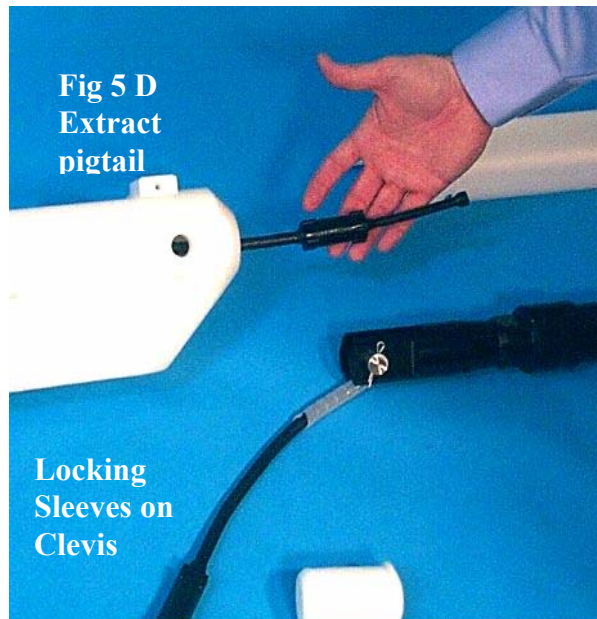
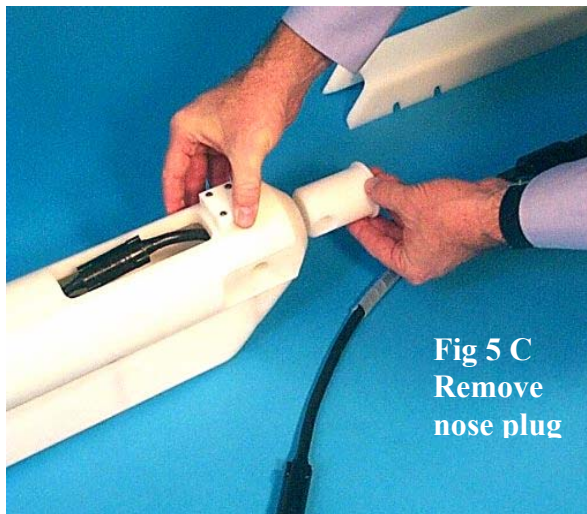
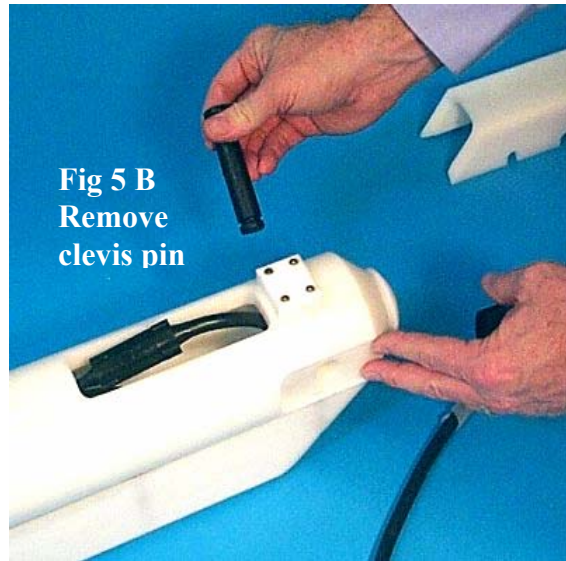

Fig 5

Next carefully pull the pigtail cable assembly from inside the nose through the nose hole (Fig 5 D) and remove the dummy plug. You do this by unscrewing the locking sleeves and pulling the dummy plug straight out. Do the same on the pigtail attached to the tow cable clevis termination.



Locate the silicone grease that comes with the ship kit (in one of the plastic bags, Fig 6, 7) and apply a very small amount of grease to lightly cover the male pins and female receptacles. Note that too much grease can interfere with proper mating and that grease need only be applied when connectors appear dry. Line up the two connectors and push



Figure 6

firmly together until they seat (Fig 8). Do not bend the cables from side to side as you do this. Firm pressure is required. Screw the locking sleeves together to complete the electrical connection. Tighten finger tight and then give another 1/8<sup>th</sup> turn. Do not use pliers to tighten the locking sleeves.



Figure 7

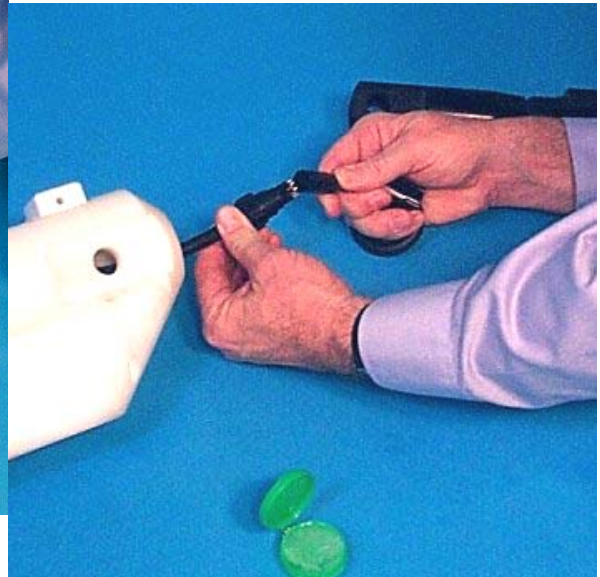

Figure 8

Now push the connected cables back through the nose hole and pull them up through the top cover port. Insert the tow cable clevis into the nose hole and secure with black clevis pin and cotter pin. ***Make sure you bend over the cotter pin after installation!*** You will require a pair of pliers to make a good bend. Complete the nose tow assembly by gently pushing the connected cables into the nose cavity and reassembling the top cover.

Pictures as shown include the optional altitude echo-sounder, your completed assembly may look different if this option is not included.

## 2.2 Converting Nose Tow to CG Tow

Converting from nose tow to CG tow is quick and easy. Remove the top cover and as shown previously (Fig 9), pull out the cable assembly and unscrew the connected cable assembly locking sleeves. Separate the cables by manually pulling them apart, straight out. Using a pair of pliers, straighten out the cotter pin holding in the black nose clevis pin, remove the cotter pin and clevis pin and then remove the tow cable assembly from the nose assembly by pulling straight out.



Fig 9

Replace the nose plug, black clevis pin and cotter pin that were removed in the first assembly process.

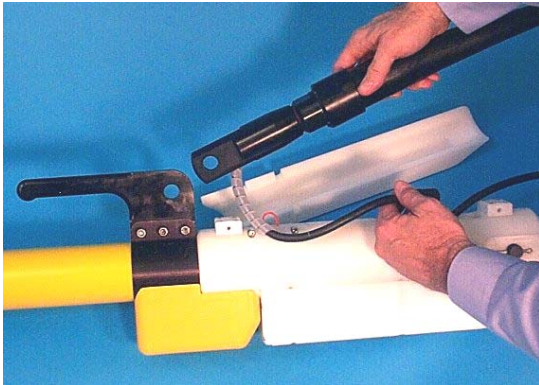

Fig 10



Fig 11

Next attach the tow cable clevis assembly to the tow point hole in the handle assembly using the stainless steel CG tow pin as shown and secure with a supplied cotter pin (Fig 10 and 11). ***Make sure you bend over the cotter pin with a pair of pliers when assembly is completed.*** Note that the pigtail cable assembly (shown with protective spiral wrap above) must exit the tow cable clevis termination as shown toward the front of the fish.

Next, inspect the male and female connectors to ensure that there is sufficient silicone grease and mate the connectors, screwing together the locking sleeves to complete the connection (Fig 12 A). Then gently push the connector pair and

cables into the nose cavity (Fig 12 B). Feed the pigtail under the top cover and secure the top cover with linchpins and split rings. See Figure 12 C for completed assembly.

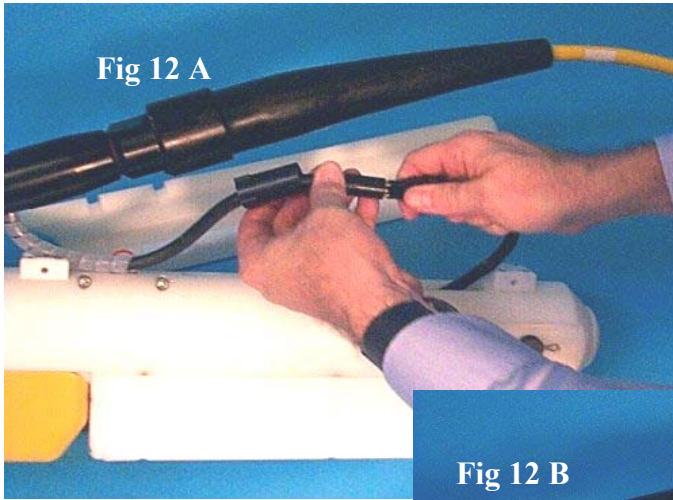
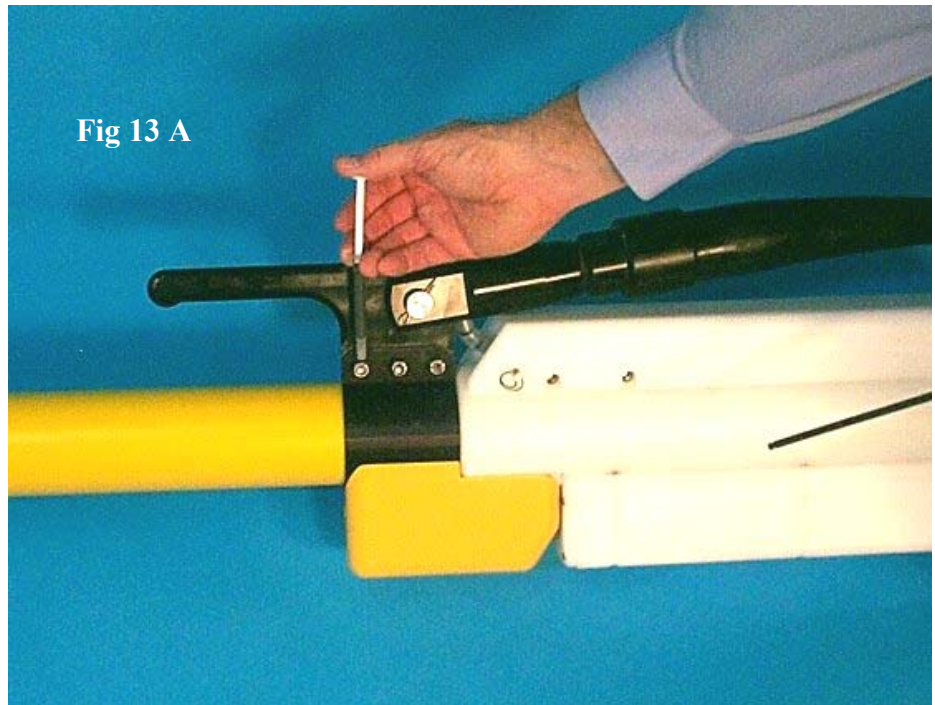

Figure 12  
Final Nose Tow  
Configuration

## 2.3 Adjusting Handle And Orientation Weight

Under some circumstances (surveying at the far north or south latitudes) it may be necessary to rotate the sensor housing by 45° or 90° (see section 4.3 on sensor orientation). To do this, loosen the three bolts holding the handle to the orientation weight collar and the clamping screws on the nose piece (Fig 13 B) and rotate the weight, handle and nose assembly by 45° or 90°. Before retightening bolts, apply some anti-seize compound that is supplied with the system as shown in Fig 13A.



Loosen these screws to also rotate the nose. **Do not remove the red locking strings.**

## 2.4 Attaching the Tow Cable to the Vessel

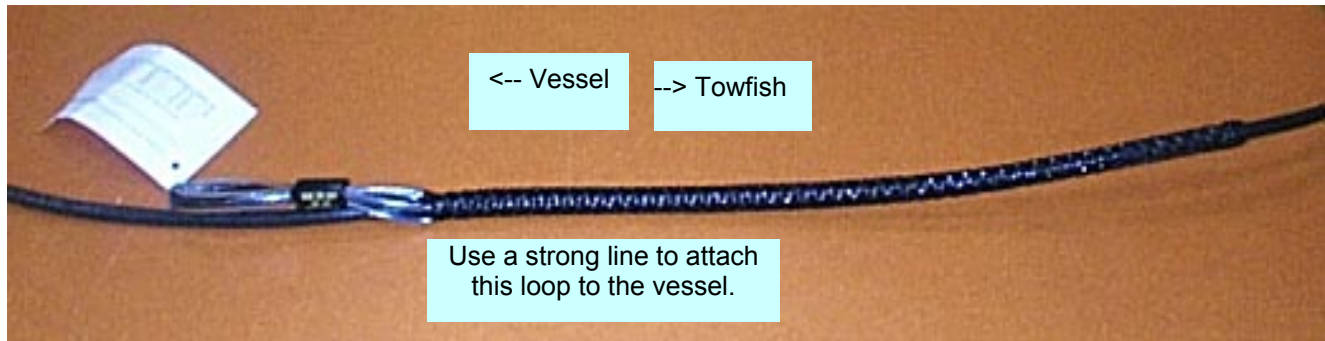

Fig 14

Each tow cable comes equipped with a Kellems grip for attaching the tow cable to a strong tow point on the tow vessel. Slide the Kellems grip to the position on the tow cable that will allow you to deploy the magnetometer to the desired distance. Attach the Kellems to the tow cable by wrapping vinyl adhesive (electrical) tape around the free end (end without the loop). The tape should be started on the cable and lap onto the Kellems. The wrapping should be applied in several layers as show in Figure 14. **DO NOT** tape along the whole length of the Kellems; this will prevent it from working properly.

Tie the loop end of the Kellems to your vessels tow point with a strong rope prior to casting the magnetometer overboard. The line and or hardware used for towing should be rated to meet or exceed the 4000 lb breaking strength of the tow cable. In addition, the tie-off point should have a similar static load rating. Additional discussion of appropriate tie points will be found in section 4.6.2.

## 2.5 Powering Up the System

Connect the tow cable to the DC/Data Junction Box (via onboard deck cable if purchased) and fix the tow cable to the tow vessel. Determine whether you will use AC power or DC power. The AC supply will accept 120/240 VAC and there is an adapter plug kit supplied for various international plug styles.

If you elect to supply DC power via two 12 volt batteries in series, note that a minimum of 24VDC must be presented to the Magnetometer. Therefore 26 to 28VDC may be required at the junction box depending on cable length. Typically fully charged batteries present about 13 volts each, and so this should function well. Discharged batteries may not have enough voltage to start the magnetometer although keeping it running once warmed up requires less voltage. The DC Power Cable is provided to connect to battery power

With all of the components of a system connected, apply power by first turning the AC supply on. There is a switch next to the mains power entry connection. If DC power is used, hook up the batteries and DC cable. Connect to the junction box.

Next, turn the Junction box DC power switch on using the locking toggle switch on the junction box. The power indicator will light up green if the DC input polarity is correct. If the DC input is derived from a battery set, there is the possibility of accidental reverse connection of the power. If this should happen, the power indicator will light up red, but no damage will occur. In this case, turn off the junction box switch and recheck the DC power connections.

When power is applied, after a short warm up period (1 to 2 minutes), the magnetometer will begin producing data. The default transmission protocol from the CM-221 counter in the G-882 Magnetometer will be RS-232 at a 9600 Baud rate. After about 2 to 5 minutes, the output from the magnetometer will be stabilized and can be observed using “View201” (a DOS program supplied by Geometrics) or HyperTerminal supplied with Windows or MagLog software. See the section under Troubleshooting (section 5.5) on how to set up HyperTerminal.

Under some circumstances you may get better data if you connect the ground lug on the DC/Data Junction Box to the ship’s hull using a ground cable. (Typical noise levels at sea will be under 0.2nT peak-to-peak and may be less than 0.1nT depending on sea state, ocean waves can generate magnetic signals). This connection may be required if the AC Mains power is grounded to the steel hull. See troubleshooting section for more information.

Connect the Logging Computer to the DC/Data Junction Box using the RS-232 Serial Data cable provided. See Figure below.

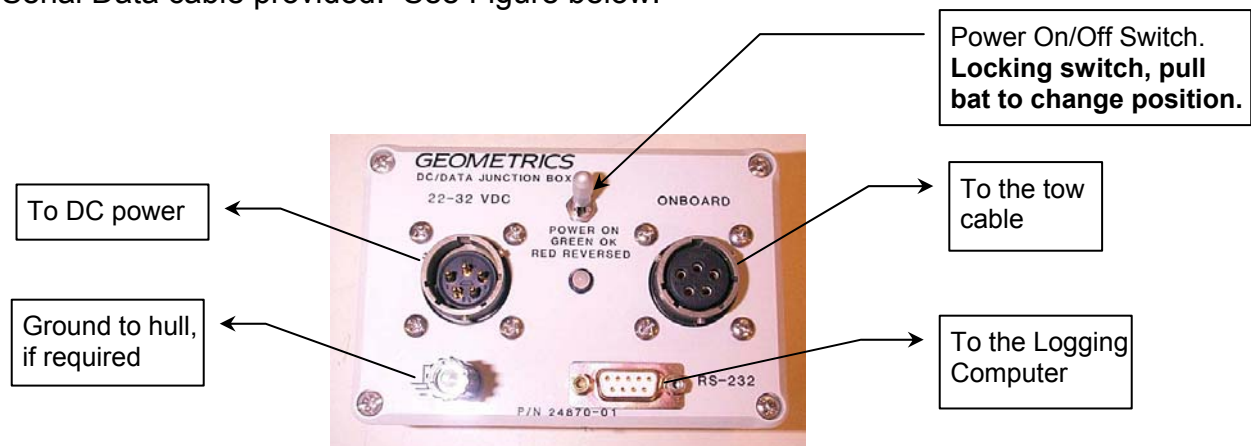

Figure 15

### 3.0 Quick Start Software Guide

This section of the manual refers specifically to the installation and setup of MagLogLite or MagLog, Geometrics data logging and display programs. We use the terms MagLogLite and MagLog interchangeably to refer to the logging programs made by Geometrics; differences in performance between MagLog and MagLogLite are not important for our discussion here. If you are using another logging program such as Coastal Oceanographics Hypack™ please read

the first section below for tips on getting a good signal from the magnetometer on board ship before setting up the software.

A cesium magnetometer will operate inside a room or lab or on the back deck of a ship as long as two criteria are met. First, the sensor must be oriented as it would be if it were being towed. In other words, for most survey areas the sensor tube cylinder (at right angles to the main sensor tube body) should be positioned vertically so that the long axis of the “T” is pointed up (see CSAZ program). Second, the sensor must not be within a few feet of large steel objects such as winches or steel decks. If the towing vessel is steel, place the sensor assembly on top of a large cardboard box or plastic drum to get it 3 to 4 feet above the steel deck. On very large steel ships you may need to move the sensor to the wharf area or deploy it a short distance aft to get sufficient distance from the steel structure.

MagLog and other logging programs require positioning information to operate properly. We strongly recommend that you have your GPS turned on and transmitting data during the software initialization process. MagLog uses the standard \$GPGGA string that all current GPS receivers transmit. Most modern computers no longer support direct serial communication ports, but all do support USB (universal serial buss) ports. We suggest that you purchase (from us or directly) a Keyspan™ 1 or 4 port Serial to USB converter unit and have it installed on your computer. This will provide one or more serial ports for use with the magnetometer system. For the G-882 system you will need two serial ports, one for the GPS and one for the magnetometer.

At this time we also recommend that you install the MagLog printer port software key (also referred to as a “dongle”) that will give you access to the MagLogLite data logging features. MagLog and MagLogLite will install from the CD but will run in demo mode unless and until a printer port key dongle is installed on the PC printer port. In case of trouble, Customer Service at Geometrics can give you a temporary software key code to type into the computer and get you running.

Install MagLogLite from the supplied CD. Insert the CD into the CD player and follow the menu selections to install MagLog / MagLogLite. The dongle will determine which version of the program initializes. Note that for most surveys, MagLogLite provides all the features you will need. MagLog is used primarily in airborne surveys and with USBL tracking systems.

With the sensor properly positioned turn on the power switch on the white junction box. A green light will indicate proper power connections, a red light indicates reversed polarity on the DC voltage input. Turn on the computer and click on the MagLog icon on your desktop. Ensure that the GPS is running and the G-882 junction box shows a green power light.

### 3.1 What Does MagLog Do?

MagLog is a sophisticated data logging and display tool that has a large number of customizable features. These features include but are not limited to the following:

- automatic calculation of fish position in real time (interpolation)
- automatic anomaly detection and Lat/Long position flagging
- plotting of GPS ship track, fish position and data on the map
- user setup of survey grid area with survey lines to show which survey lines have been completed on the GPS track screen
- Automatic start stop of logging when sensor is in survey area
- multiple “slots” with multiple “pens” so that many different kinds of data can be displayed simultaneously. Arithmetical operations like Depth + Altitude to show water column; gradient calculations
- printing to dot matrix or to inkjet or laser printers which can be set up to print only when there are detected anomalies
- survey playback at high speed to search for anomalies

There are many more features but the purpose of this section is to show how to set up MagLog and quickly begin logging data. For this purpose we use the Survey Wizard which you will find listed under File on the MagLog menu bar. Click on File and then on Survey Wizard (see Figure 16 below). After the introduction screen is displayed, click “Next”.



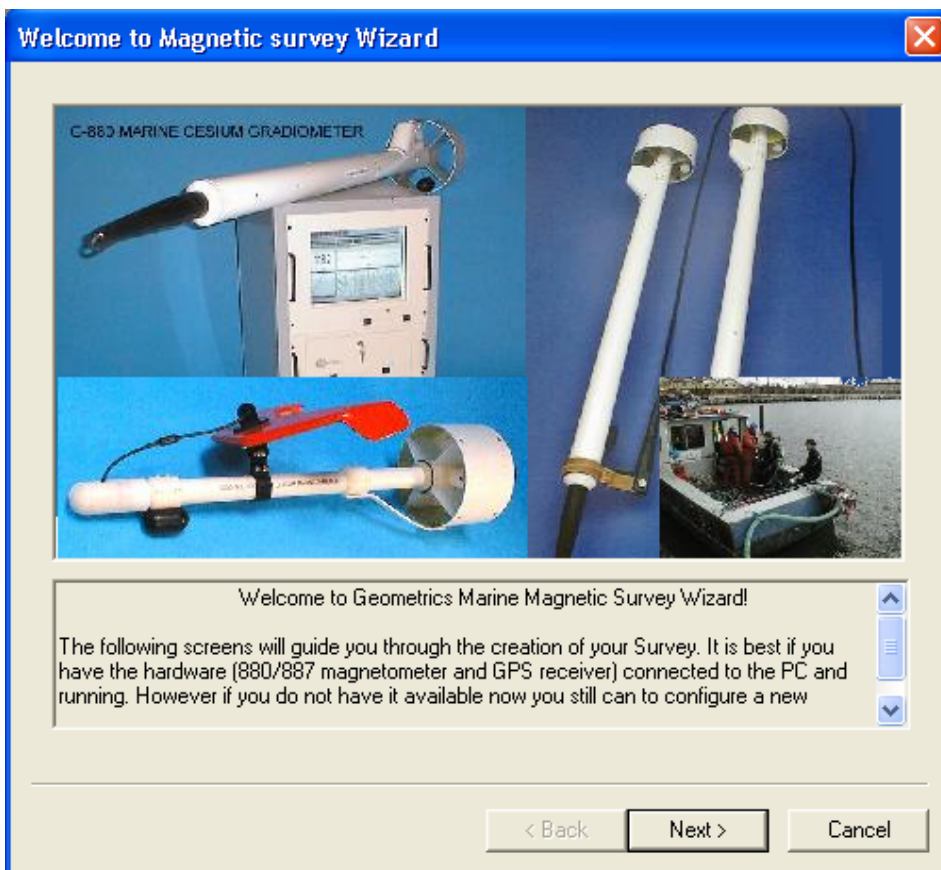

Figure 16

## 3.2 The Survey Wizard

The Survey Wizard will take you step by step through the initialization process to set up the GPS, magnetometer, real time layback calculation (interpolator), printer and depth and altitude sensors (if included).

The next screen asks us to define a new survey name. In this case we have used “test.survey” as our survey name. Note that the program creates several files based on this root name, including files for the GPS, for the magnetometer, a file for the line number, another for the Interpolator, which is the file with the actual relocated fish positions. Type in a name and click next (Figure 17).

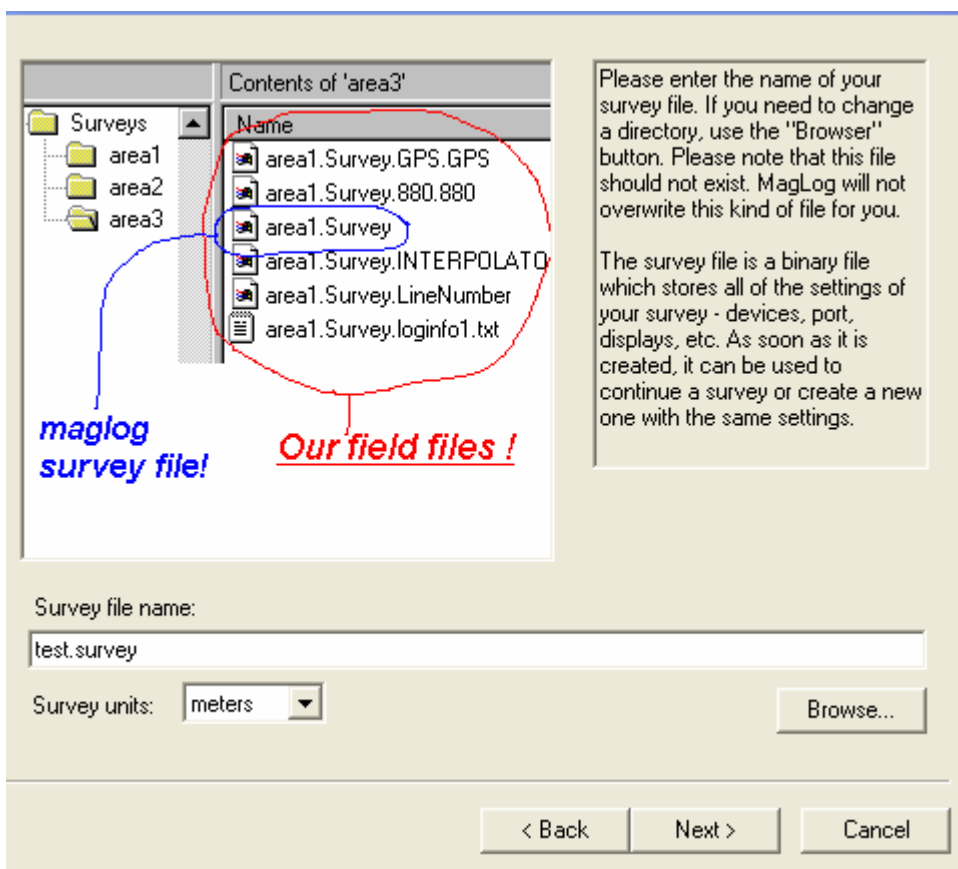

Figure 17

The next screen shows the GPS communication setup parameters. You should have the GPS connected and sending data at this time.



Figure 18

Set the Port to the proper number and baud rate value (if you do not know this information the program will scan for it) and then press the “Autoset communication parameters” button. When the program detects the GPS it will report back as below:



Figure 19

The next screen offers a facility to import Arc Info shape file maps. This is a feature covered in the MagLog Manual and for later discussion. Press next.

Figure 20 shows the magnetometer setup screen. As before, if you know the name of the communications port the mag is using and the baud rate (default 9600 baud) set it now. Otherwise the program will search for the connection.

Select the type of magnetometer you have where 88x stands for all marine Geometrics Inc. G-882 Cesium Marine Magnetometer Page 17

magnetometer systems. Essentially we are selecting one mag, or one mag with depth sensor or one mag with depth sensor and altitude echo-sounder (or two mags for gradiometer array). The cycle time is set in tenths of a second, e.g. 0.1 means 10 samples per second, which is the system default. Click on "Autoset communications parameters" to interrogate and set up the magnetometer communications.

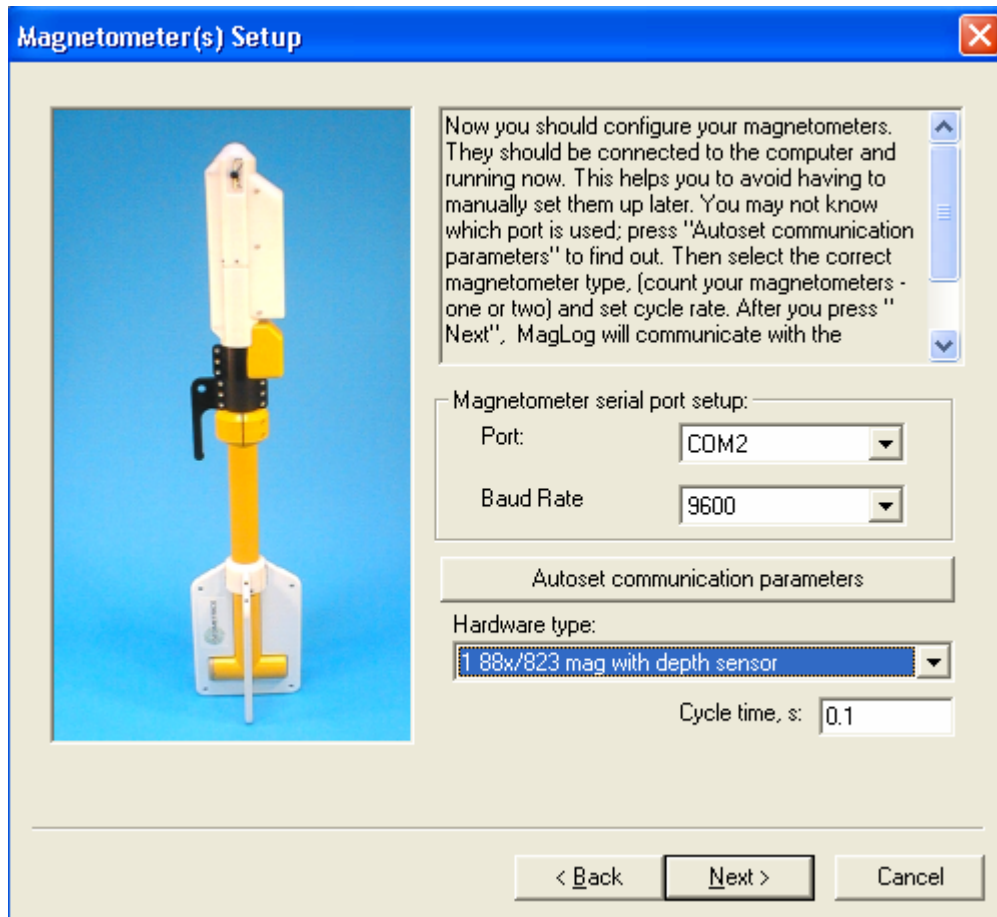

Figure 20

You will get a screen as shown in Figure 21 while the magnetometer is being detected. You will be notified when the magnetometer is communicating and setting the analog channels (used for depth and altitude). Note that the 1<sup>st</sup> analog channel is always reserved for magnetometer signal strength. Therefore, if you have 1 and 2 shown in this screen, 1 is signal strength and 2 is depth transducer.

At the bottom of the screen is a button named Store Configuration. When this button is pressed, the default settings (power-up default parameters) are loaded from MagLog into the magnetometer CPU Flash memory. This means that you can change how the magnetometer initializes so that it will wake up with the

proper number of channels turned on and the selected cycle rate, etc. If you make changes to the magnetometer operation and wish to store them permanently in the Flash Memory, use this button. You can change the stored parameters at any time.

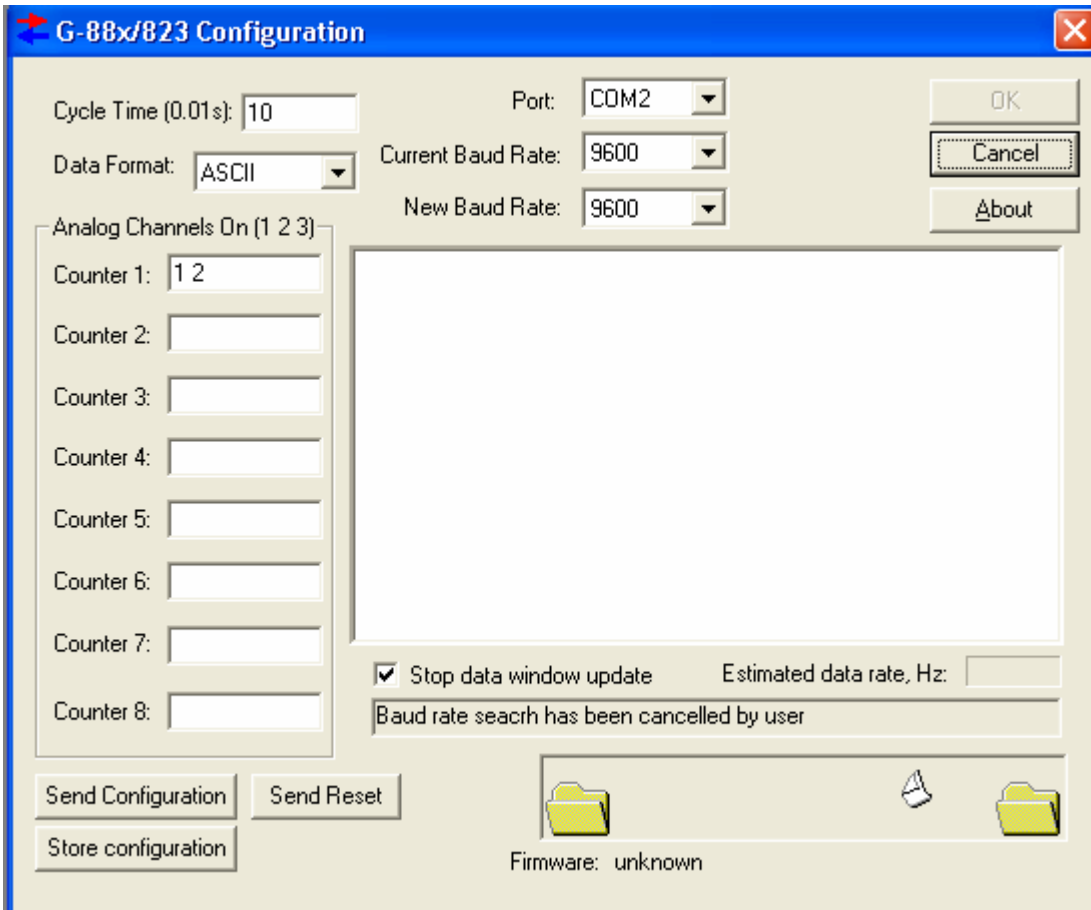

Figure 21

The next screen enables the user to enter the calibration coefficients for either the depth sensor, altitude echo-sounder or both. These coefficients are found on the tailfin of the magnetometer and in the accompanying documentation.

For the depth sensor calibration, enter the scale and bias information for the type of water in which you will be surveying (different scales and biases are supplied for saltwater and fresh water surveys). If you have an echo sounder altimeter installed, enter the scale and bias information for that accessory as well. When you have completed entering the data, click next to continue. (see Figure 22)

If you do not have the calibration coefficients for your system, you may use the manual calibration facility included in MagLog. This feature is accessed from the configuration menu for the particular device and will be covered later in this manual under section 2.5.5.

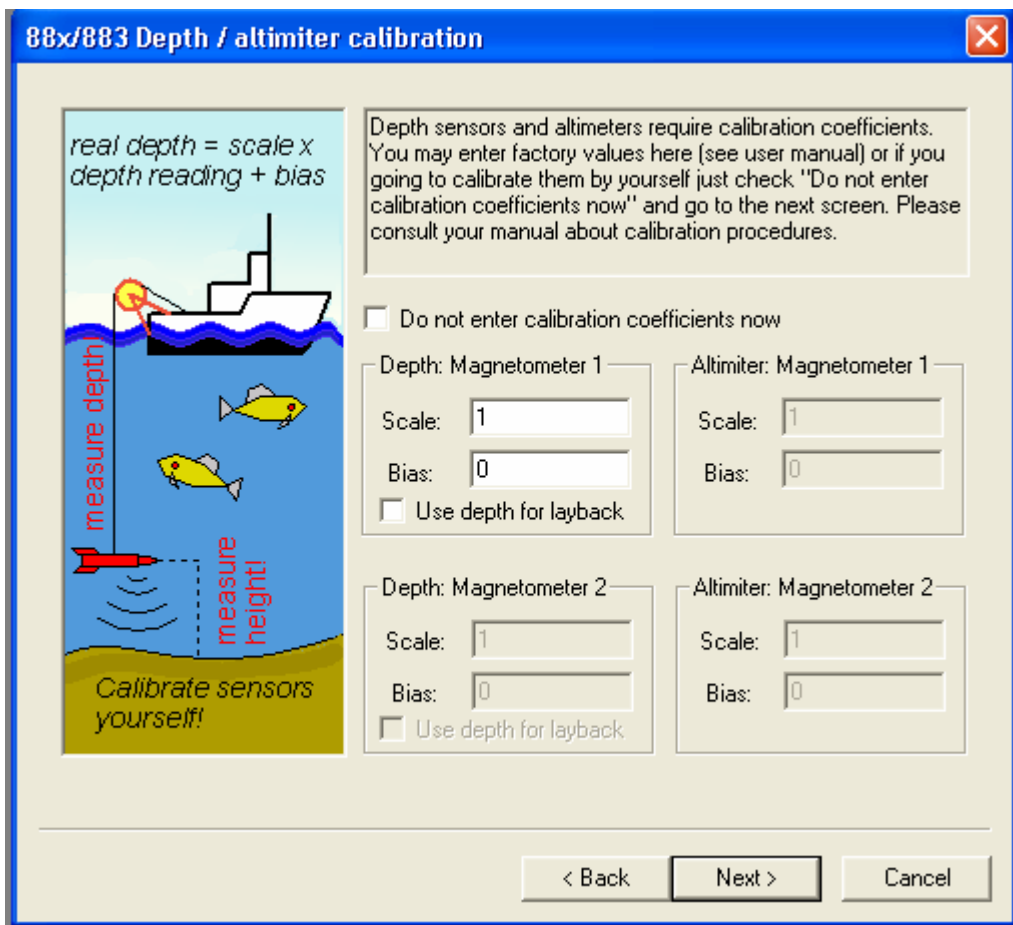

Figure 22

The next screen presented will set up the Interpolator feature. The interpolator does the following:

1. Uses the GPS antenna latitude and longitude information and converts it to UTM coordinates in meters.
2. Based on user input in this section (offset of antenna from tow point, length of cable deployed), the program computes the position of the fish in UTM coordinates. MagLog employs a proprietary "dragging algorithm" which analyzes the track of the boat and makes a best estimate of the position of the fish based on the physics. The computed UTM fish position is then recalculated in Lat/Long and that information stored in the Interpolator file (\*.int).
3. This process occurs at 10 or 20 times per second (Hz) so that the position of the fish is computed and stored with every reading. Because the GPS information typically comes at 1 or 2 Hz, the position of the fish is interpolated in between GPS fixes. This is why the feature is called the Interpolator.
4. Addition of a heading Compass or Gyro greatly improves the computation of the fish position. This is because when the ship is pointed in a direction different from the direction of travel (due to side currents) the currents also affect the position of the cable and fish system. MagLog will log common

Gyro and Fluxgate Compasses for automatic correction of side currents.  
Contact Geometrics for more information and a case study.

To use the Interpolator feature, click the button that says “Yes, I want real time layback calculation”.

The Survey Wizard provides set up of the Interpolator to calculate the positions of one or two sensors (more “fish” may be added later) in real time. If a gradiometer array is being deployed, the sensors may be configured in either a longitudinal (one behind the other) or transverse (side by side) manner. You have the option of putting in information to describe either configuration. For typical one sensor surveys, use the longitudinal configuration button.

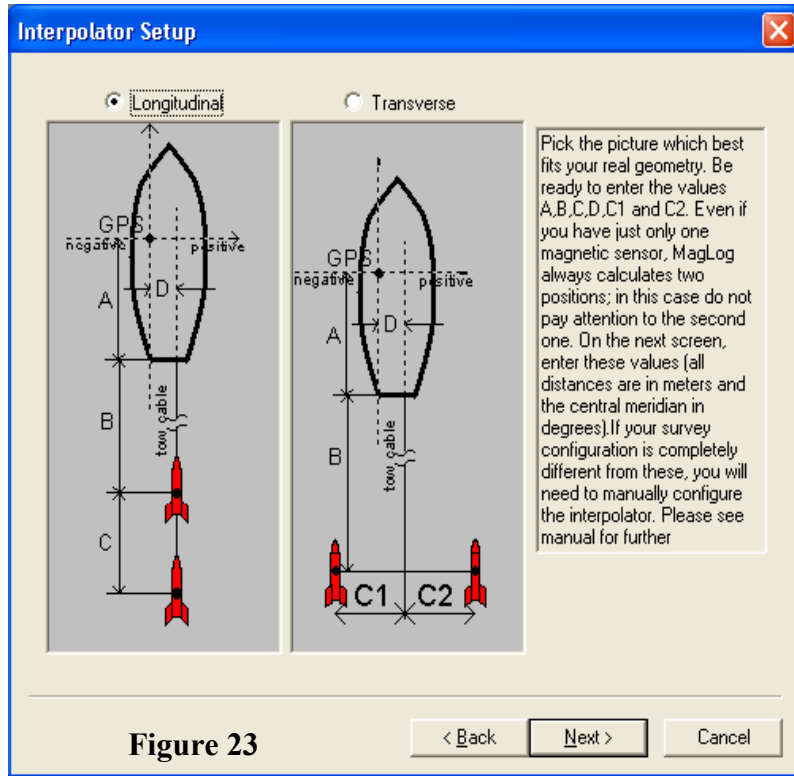

For a single sensor installation you will be defining the geometry by entering information regarding distances defined by A, B and D in the left of Figure 23 above.

Enter data as shown in the Figure 24 below to define the position of the GPS antenna relative to the tow point on the back of the ship, and the amount of cable deployed. MagLog will then interpolate and calculate the fish position in Lat/Long in real time for the purposes of drawing the fish position on the GPS screen during actual survey (make sure you click the box that says “Draw 1-st fish real time”). In addition, this information is used to flag anomalies that exceed your preset anomaly detector criteria set up in the “Configure Input Devices” described later. A table of these anomalies may be exported for direct import into programs like Geosoft, MagPick and Surfer to show the location of the targets. This is of course much better information than simply the location of the boat at the time the fish passed over the anomaly. Now the user can steer the boat using the GPS, back to the calculated location of the fish when the anomaly was detected.

Put a “0” in the “Second Mag offset” if there is only one tow fish deployed and two are shown (Figure 24). Recent versions of MagLog will have only the number of fish displayed that are logged, however your program may show two fish. Make sure you have the latest version from our web site or contact us for a CD.

The next screen in the Survey Wizard shows the user how the Interpolator file will be generated. Note that all relevant data is stored including magnetic field, signal strength, sensor depth and altitude if available, GPS position, fish 1 and fish 2 position, etc. This file may be brought directly into MagMap2000 using the “all files” input description in order to plot the actual fish positions for further analysis (Note: bringing in MagLog \*.survey files [pertains to MagLogLite as well] give ship position plots, not sensor position plots. Only bringing in Interpolator files will show the actual calculated fish position on the GPS track plots in MagMap2000.

You may save this header file for future reference using the “Save this information to file” button.

Next the Survey Wizard will help us define the look and feel of the logging display (Figure 26). We are presented with certain default “slot” line colors and plot definitions. We recommend that you use the Horizontal (Landscape)

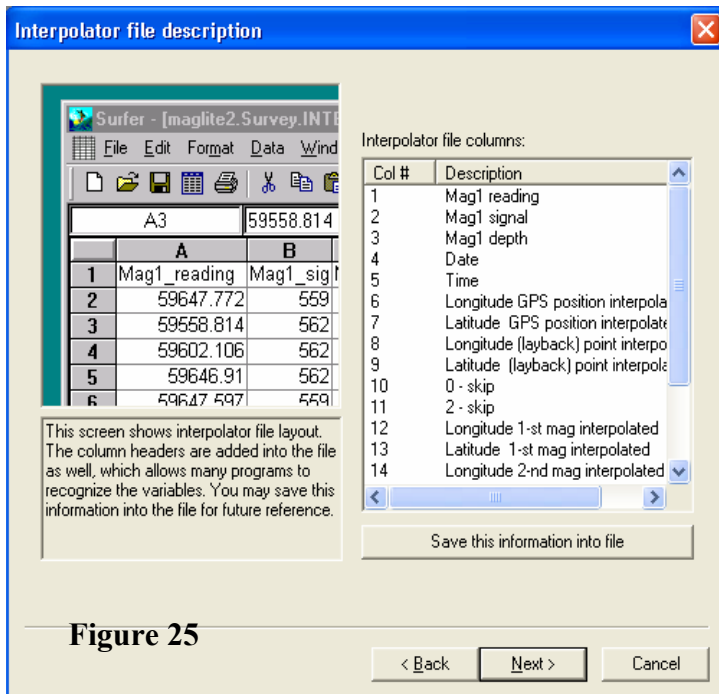
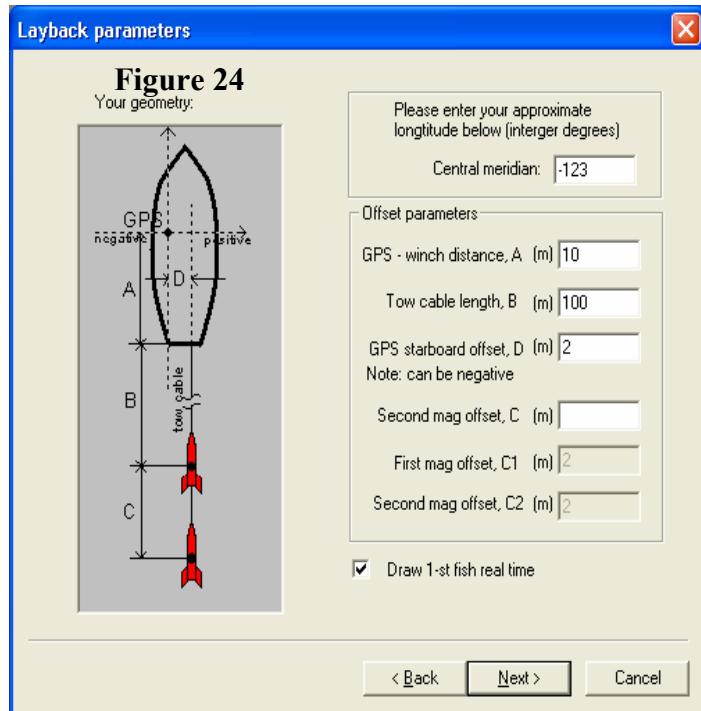



display mode and that you accept the basic wizard color definitions at this stage of set up. You can always change these items later during program operation.

Slots are defined as subsets of “Windows”. Windows may have one or more slots and in each slot there may be one or more pens. Pens may represent such things as depth in meters or magnetic field with 200nT full scale and a second pen in the same slot with 20nT full scale. Configuration of these parameters are covered in more detail in the MagLog manual.

The next screen shows the Slot Display parameter controls (Figure 27) which set the full scale value, grid settings and chart speeds of the graphics presentations. We recommend that you just accept these parameters as defaults for now. Again, these can be easily changed once the program is running.

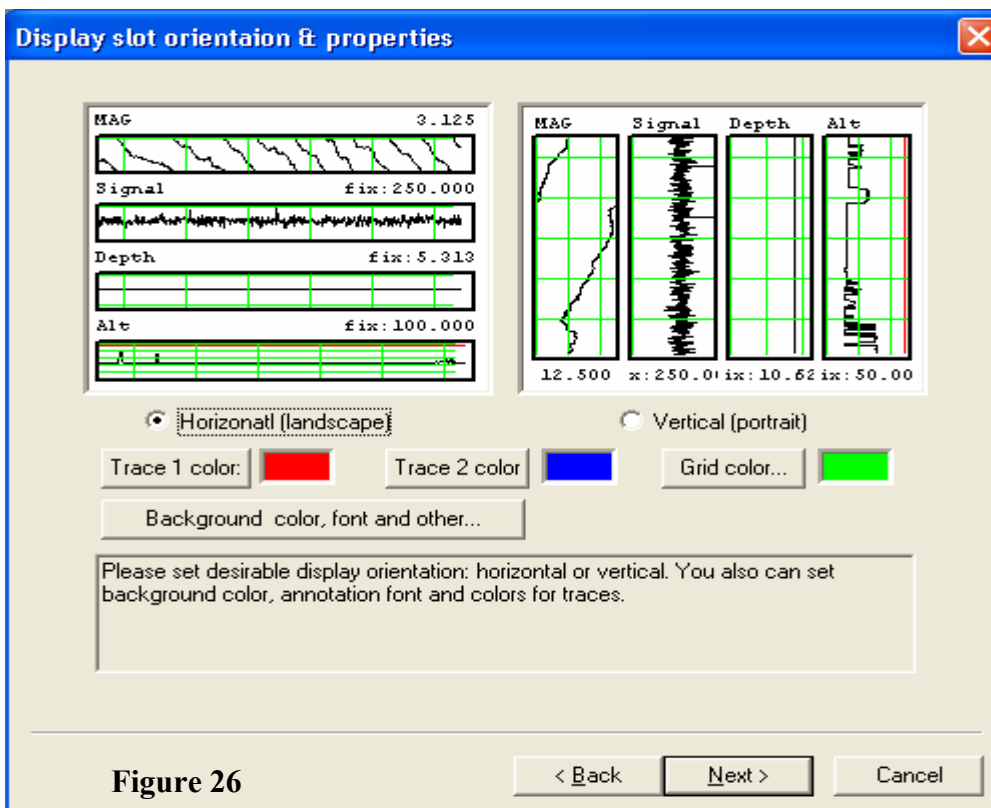

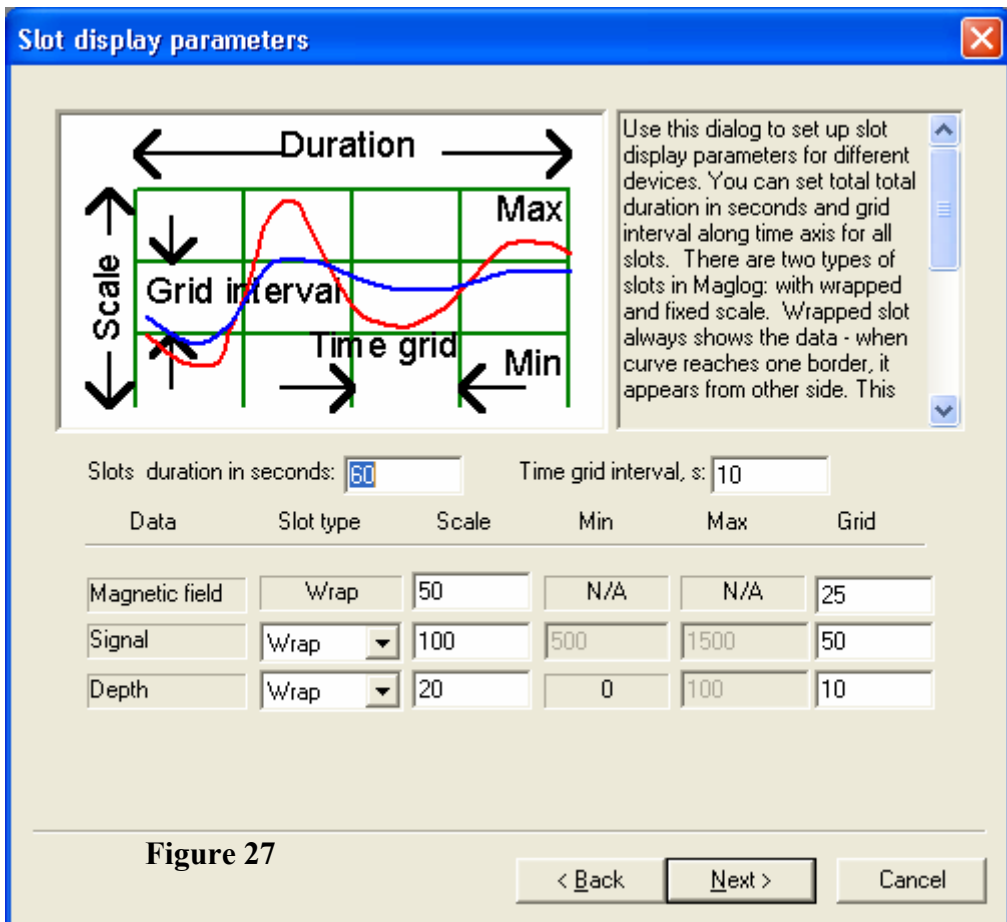

The Survey Wizard now asks us to set up either a dot matrix printer or laser/inkjet Windows printer for making hardcopy of the data on site. Note that if you do not intend to make printouts in-field plots of the data, you do not need to set up this feature. Of the two types (dot matrix and Windows™ laser/inkjet printers), we recommend the user of the Windows™ printers (see next screen, Figure 29). The reason is that while dot matrix printers

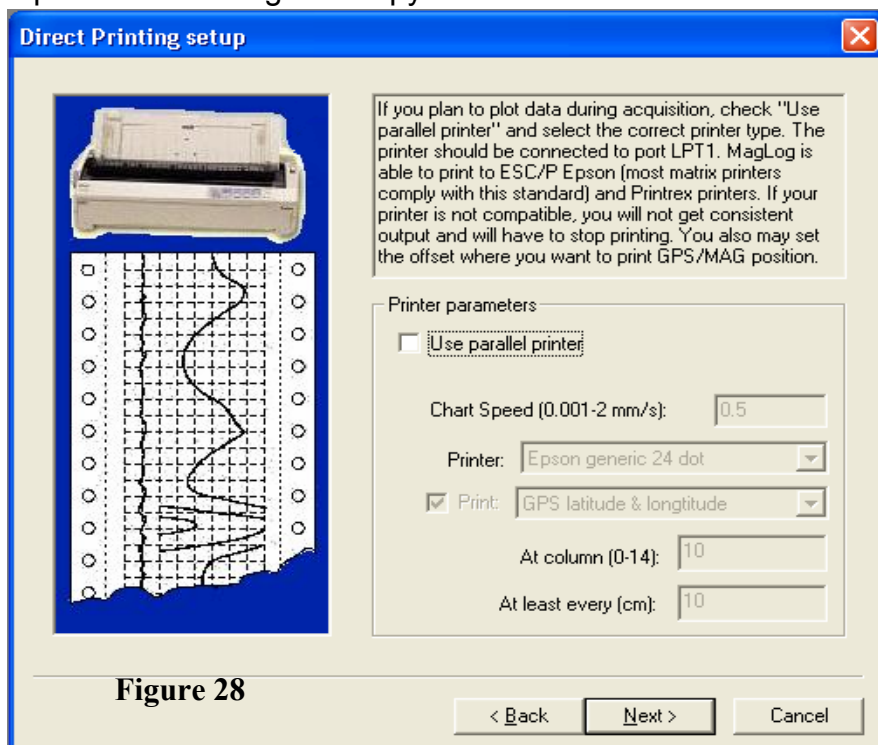

use continuous roll paper and can plot the entire survey in one profile, the Windows™ printers may be configured to print on anomaly only. Thus when an anomaly exceeds the preset values it will be printed with positions and other data as selected on the center of an 8 1/2 x 11 inch sheet.

Note that when you configure the “Windows” printer, you must have the printer connected to the computer or network and turned on.

This completes the Survey Wizard dialog boxes and this Quick Start Software section. Clicking on the final screen of the Survey Wizard will start the survey. Note that the program starts in display mode only, and that in order to log data you must use CTRL-S to start logging the data (or File – Start Logging).

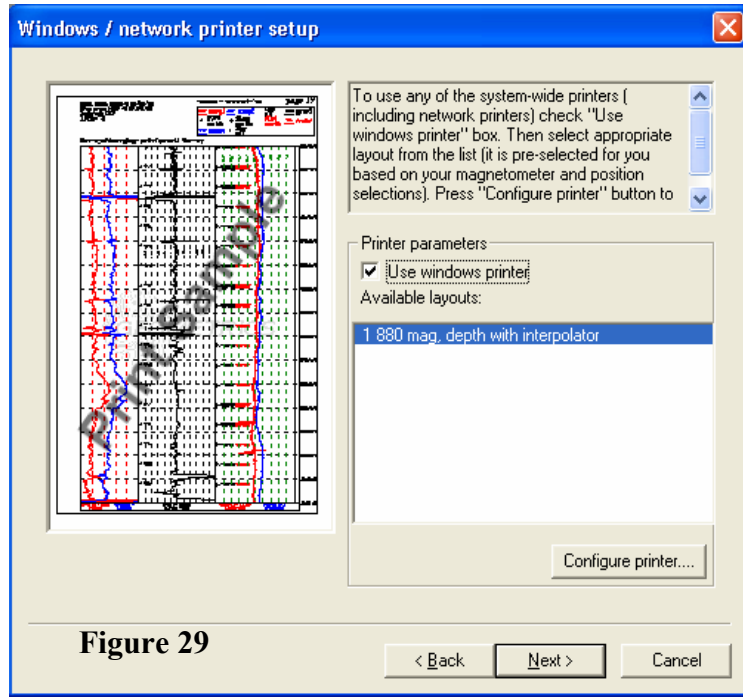

Figure 29

The following sections deal with deploying the sensor in different latitudes and technical data regarding data formats. The final sections include a trouble shooting guide and contact information.

## 4.0 General Overview

The G-882 Marine Magnetometer consists of two modules: sensor and sensor driver electronics module mounted in a fiberglass pressure vessel. The G-882 sensor driver module contains a CM-221 frequency counter which is used to count and digitize the Larmor frequency. The counter then transmits the data in digital RS-232 format up the tow cable.

A basic description of the physics employed in the G-882 Marine Magnetometer, and optically pumped resonance magnetometers in general, is included in Appendix A under Cesium Vapor Magnetometer Theory.

### 4.1 Operation and FAQ

The G-882 Marine Magnetometer is usually purchased with Geometrics logging software package **MagLog-Lite™** or **MagLog™**. Please refer to the Manual associated with this software for complete instructions regarding installation and setup. If **MagLog-Lite™** or **MagLog™** are not purchased, other serial port

logging software or terminal software may be used to communicate with the G-882. Refer to the front of this manual for the **Quick-start G-882 Hardware and Software Operating Instructions** to help with the initial setup and running of the magnetometer.

We receive many common questions about how to operate the G-882 magnetometer and we offer a few of them here for your review:

*A. What is a good boat speed? Is there a maximum or minimum?*

Most surveys are conducted at between 4 and 6 knots. The speed of the vessel will control the depth of the sensor fish because the drag of the cable dominates. Therefore higher speeds mean a more shallow tow. The tow cable is rated for 700 lbs continuous working load. Short tow cables (less than 500 ft) can be towed at up to 10 knots.

*B. I want to tow 200 ft deep, what are my options?*

In general, we suggest that you use our online depth calculator offered on our website at <http://www.geometrics.com/TowDepth.htm>. Users can substitute G-881 for the G-882 in the program. (See Figure 30 below).

A quick calculation will show you that getting your sensor to 100 feet depth (30m) is not too difficult but to get beyond that depth, it will require significantly more cable, slowing down the survey and adding weight collars to the fish. Each weight collar is 14lbs. To get to 100 ft (30m) depth will require 500 ft of Kevlar cable, towing at 3 knots with 1 extra 14lb collar weight. Moving to 4 knots will raise the fish to a depth of 75 feet (25m)!

## Tow Fish Depth Estimator

Warning: results are only approximate. Use this only as a general guide  
Actual tow depths may vary considerably!

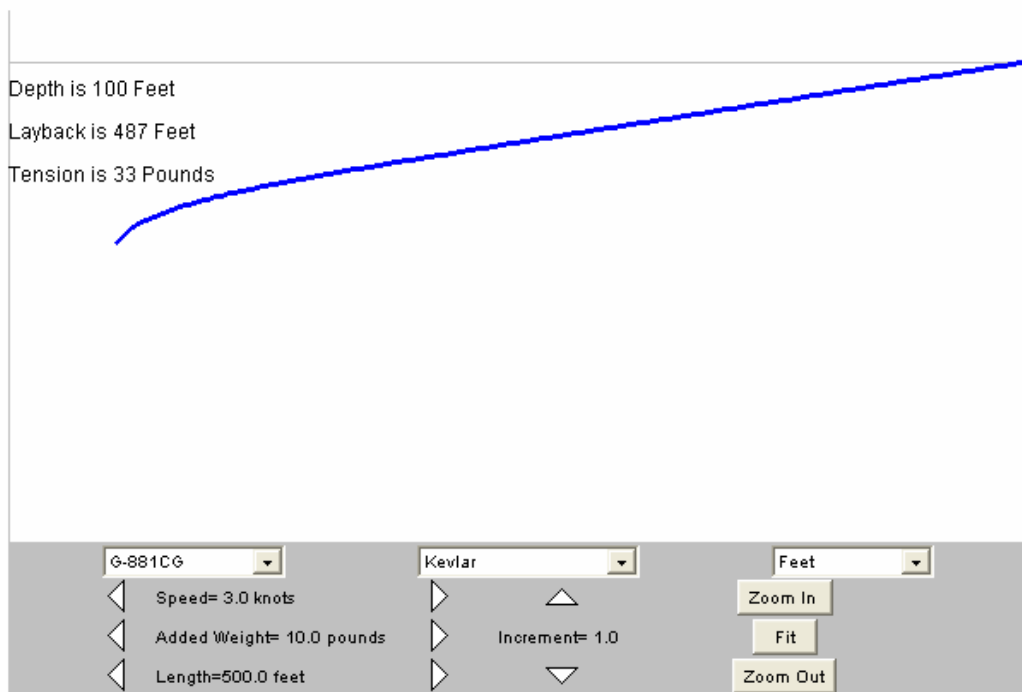

**Figure 30**

To get very deep we offer steel armored coaxial cable with a telemetry system and high voltage power supply. This system can operate over 6 to 10 Km of steel coax cable.

### *C. How tight a turn can I make?*

Tight turns remove the forward tension on the tow cable and therefore allow the sensor to sink. The tighter the turn, the longer the cable and fish will be without forward motion. Long cables will also lengthen the sink time. We recommend keeping the sensor under forward motion by performing an eye-bolt type maneuver or using a racetrack pattern (line 1, line 6, line 2, line 7, etc) to keep forward progress.

### *D. Isn't Cesium radioactive?*

There are certain isotopes of cesium that are radioactive, but we do not use radioactive isotopes in cesium magnetometers. We use extremely small amounts (micrograms) of the pure elemental metal which is non-radioactive and essentially non-reactive in those amounts.

### *E. How far can the magnetometer "see"?*

Total field magnetometers like the optically pumped cesium magnetometer are passive devices, they do not send out waves or pulses. They measure distortions in the earth's normally homogenous magnetic field and can sense distortions due to ferrous objects at great distances.

The basic rule of thumb is that one ton (1000 Kg) of steel or iron will give us a 1nT anomaly at 100 ft or 30m. Since the amount of distortion falls off as the cube with distance (compare a metal detector which falls off as the inverse 6<sup>th</sup> power!) and is linear with mass, every time we cut the distance in half, we can see 1/8<sup>th</sup> the mass. Therefore, we can sense 250 lbs (100kg) at 50 feet (15m), or 30lbs (15kg) at 25 feet (8m), or 4lbs (2kg) at 12 feet (4m). However this is not the whole story. The factors given above are for induced magnetic fields only. Many targets also have remanent or permanent magnetic effects (meaning they have become magnetized either in production or by the earth's field) and can therefore have larger anomalies by a factor of 3 or 5 or more. Also many hollow objects like barrels or other tubular structures appear as though they are solid due to self-shielding from the earth's field, and thus have much larger anomalies than their mass would predict alone. Pipes fall off as the inverse square and are thus detectable at even greater distances. Please see our Applications Manual for Portable Magnetometers for more information. Our website contains additional FAQ questions.

## 4.2 Performance

Geometrics G-882 magnetometer produces a Cesium **Larmor** frequency output at 3.49872 Hz per nT (in this text, nT refers to nanotesla or gamma or 10<sup>-5</sup> gauss). Thus, in a nominal 50,000 nT field this frequency is about 175 kHz. The output of the system is a continuous sine wave at the Larmor frequency. The typical signal amplitude is approximately 2 volts peak-to-peak at optimal orientation of the sensor.

This frequency is counted with the internal counter at 10 readings per second but the cycle rate can be set to one reading every 3 seconds to 20 times per second.. The G-882 is intended for use in marine applications, and operates over the earth's magnetic field range of 20,000 to 100,000 nT.

Absolute accuracy (relative to National Bureau of Standards facility at Fredricksburg, VA) depends on sensor orientation, internal light shift and the accuracy of the external counter's time base. Typically cesium magnetometers offer absolute accuracies to within  $\pm 2$ nT of this standard. Since the offset if any is constant (no drift over the lifetime of the product) this is of no consequence in survey activities. Orientation error of the G-882 does not exceed 1 nT p-p (peak-to-peak) throughout the entire 360° polar and equatorial spins of the sensor.

Like all magnetometers, performance of the G-882 in a mobile installation is primarily dependent upon the stability of the tow fish and the proximity to large steel objects (e.g., the tow vessel). Navigational or positional errors, radiated

electromagnetic noise and heading error from the ship's induced and remnant magnetic fields are typically the major contributors to "noise" in the marine environment.

The G-882 Sensor Package consists of a sensor head and sensor electronics package joined by a cable. The electronics package contains an integral Geometrics CM-221 counter which converts the Larmor signal into a magnetometer reading in nano-Teslas. Digital data is transmitted via RS-232 to a data logging system. An eight pin underwater connector on the sensor electronics package receives power on two pins. Three pins are used to provide an RS-232 connection upon which the G-882 transmits magnetometer data readings in digital format. The other pin(s) is reserved for future and special uses.

Environmental conditions for proper operation are -35 to +50°C (-31 to +122° F). The G-882 will operate to a depth of 4,000 psi (≈9000 ft.).

### **4.3 Sensor Orientation Guide**

The G-882 is designed so that the sensor optical axis is perpendicular to direction of the tow. The sensor may be oriented at any angle from vertical to horizontal by rotating the main fish tube or "T" section.

The sensor head should be oriented so that the earth's field vector arrives at an angle of from 15° to 75° to the optical axis of the sensor. The earth's field vector is vertical at the poles, between 50° and 60° in the mid latitudes and horizontal at the magnetic equator. (See CSAZ program on Magnetometer CD). Adjusting the sensor for the polar and mid-latitude regions is simple, by orienting the sensor either at 45° (rotating the main tube 1/8<sup>th</sup> turn for polar regions) or 0° (no rotation required at mid-latitudes) respectively. The vast majority of surveys will be conducted using these two orientations.

The equatorial region is a special case. There is a band of approximately 500 miles wide in which the magnetometer can survey only in certain directions with a given sensor orientation. For instance, if the survey will be conducted in an east-west direction at the magnetic equator, simply rotating the sensor to the 45° position (same as for the polar region) will produce excellent data

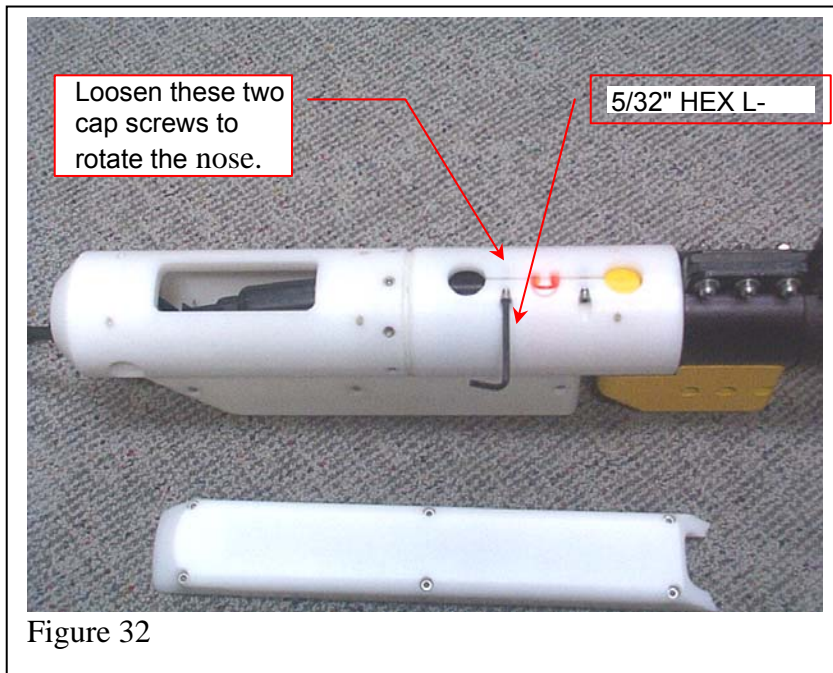
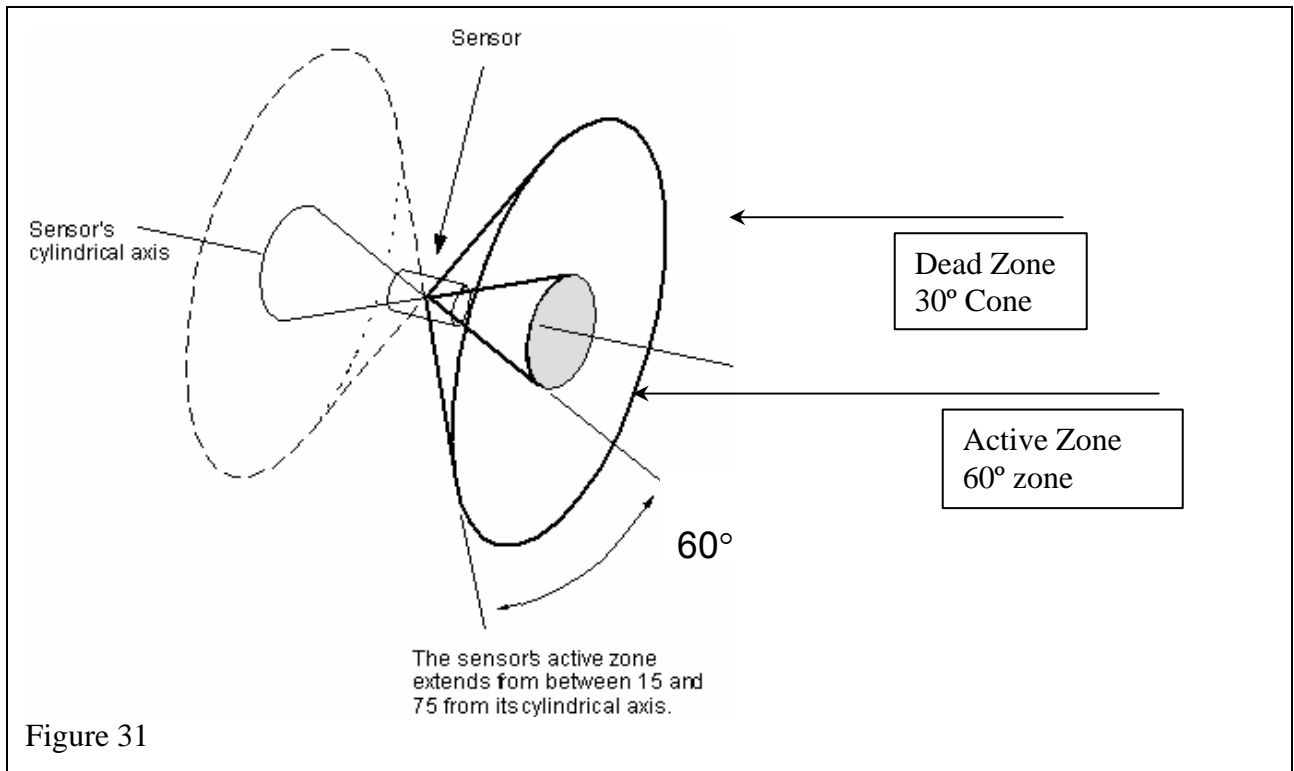

The Geometrics program "CSAZ" available on your CD or our website will give the user the optimal sensor angles for the area of interest. See the CSAZ manual (under help in the program) for further explanation of the use of CSAZ

Changing sensor orientation is simple. This adjustment will allow the sensor's optical axis roll angle to be set to any angle (typically only 0°, 45° or 90° required.)



This roll angle is set by the position of the keel weight on the tow fish body in relation to the "T" containing the sensor. To change this angle, loosen the three clamping screws at the top of the clamp and rotate the keel weight to the desired position and then tighten the clamping screws (Figure 33)

NOTE: In current design, the carrying handle attaches directly to the keel weight so that loosening the carrying handle will also loosen the keel weight allowing rotation of the weight and handle at one time.

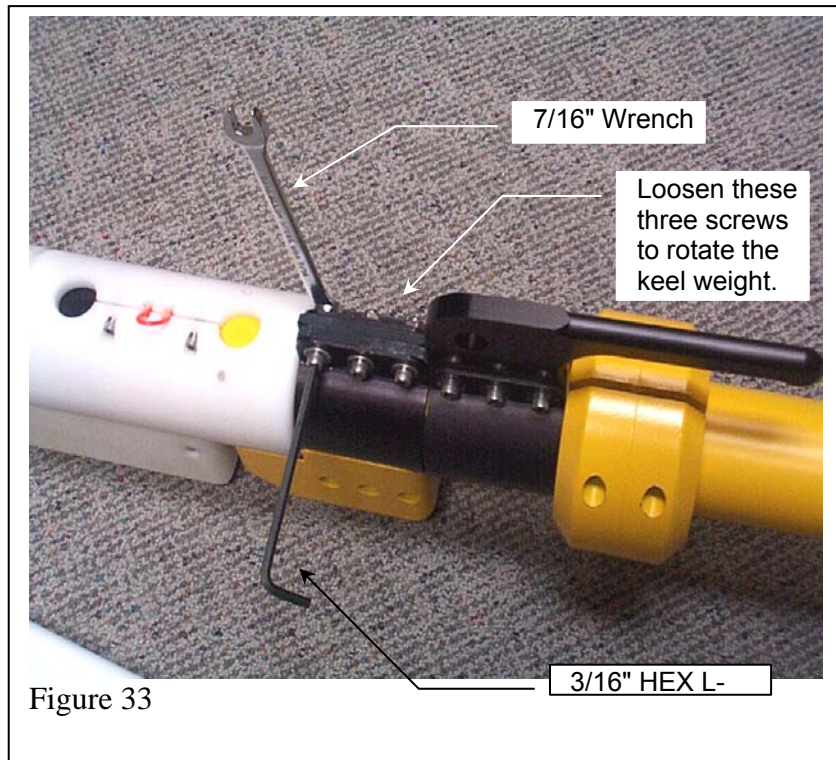

Figure 33

If a echo-sounder Altimeter is employed, then you will need to rotate the nose of the fish also to keep the altimeter pointed towards the sea floor. Simply remove the nose top cover and loosen the clamping screws (Figure 32) and rotate the nose to line up the altimeter with the orientation weight. Retighten the nose clamp screws and you are done. (Note: Do not remove the red trimmer string that attaches the nose to the fish body unless you are replacing the nosepiece).

#### 4.3.1 Sensor Positioning in Relation to the Dip Angle of the Survey Area

Optimal positioning the G-882 cesium sensor is necessary to insure that the best performance will be obtained for any given survey area. To accomplish this, we recommend that the sensor be oriented such that the Earth's magnetic field lines (H field) are centered in its active zone. We also want the orientation to provide nearly equal performance in all four towing directions (forward and reverse of two orthogonal towing directions for tie lines) to facilitate a methodical survey plan. To get information about sensor orientation we suggest you use the program CSAZ available from our website and on the Magnetometer CD for complete worldwide survey recommendations.

You can use the INCLINATION map (see figure 35) to estimate the proper orientation angle anywhere in the world as described below. A TOTAL INTENSITY map is also provided to enable determination of the expected range of readings for the survey area (see figure 36).

Since the G-882 has “automatic hemisphere switching”, reversing direction is automatically handled and identical sensor positions are required for operation in the Northern or Southern hemispheres. Thus there are three regions in either hemisphere that are of interest with regards to positioning the G-882 cesium sensor. These regions have dip angles or magnetic field inclination angles of  $0^{\circ}$  -  $22.5^{\circ}$ ,  $22.5^{\circ}$  -  $67.5^{\circ}$  and  $67.5^{\circ}$  -  $90^{\circ}$  in either hemisphere.

Assembling the G-882 as pictured below (vertical sensor) provides the best operation in the  $22.5^{\circ}$  -  $67.5^{\circ}$  region. Note that in this picture the orientation weight and CG tow point are attached to the tow fish such that the cesium sensor will be maintained in a position vertical to the Earth’s surface while under either nose tow or CG tow.

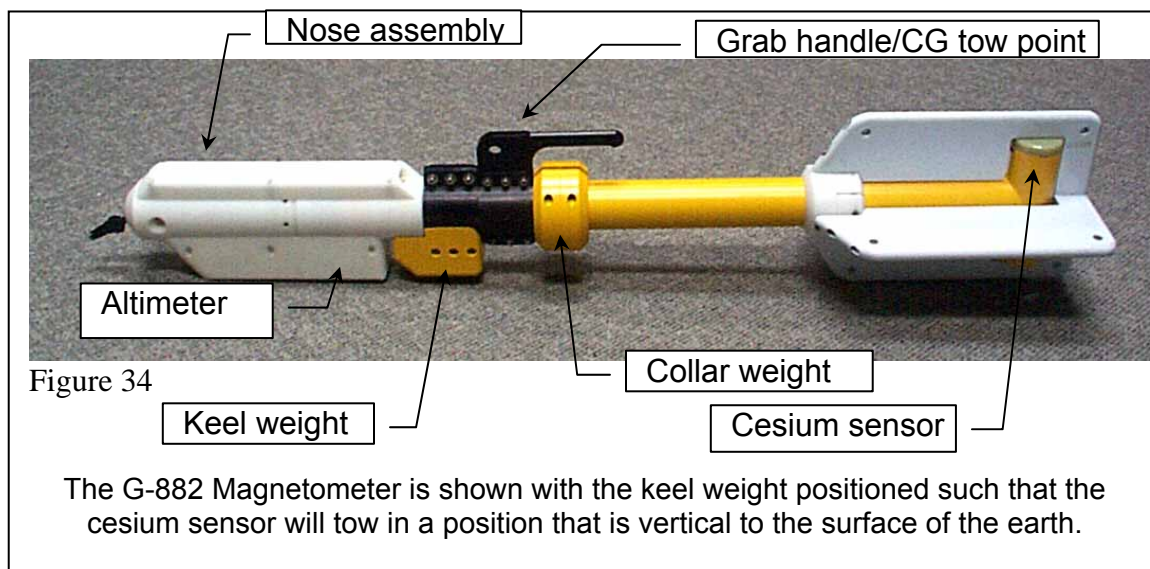

If an altimeter is present, the nose assembly must also be adjusted so that the altimeter is also directed towards the seabed. See previous section on adjustment procedures.

For the  $67.5^{\circ}$ - $90^{\circ}$  inclination angle regions, roll the sensor to an angle of  $45^{\circ}$  with respect to the Earth’s surface.

For the  $0^{\circ}$ - $22.5^{\circ}$  inclination angle regions, roll the sensor  $90^{\circ}$  until it is horizontal with respect to the Earth’s surface. CSAZ has more information on fine tuning this orientation in equatorial regions.

**Roll angles other than 0°, 45°, and 90° tend to produce signal to noise ratio patterns that are asymmetrical. This could cause unequal instrument performance in the reverse and orthogonal directions of a typical survey. See CSAZ program.**

#### **4.3.2 Main Field Inclination and Total Intensity Maps**

The maps on the following two pages may be used to determine the inclination and total intensity of the Earth's magnetic field in the survey area. The inclination information may be used to properly adjust the sensor position for the best performance in the intended area of survey. The intensity information may be used as a check of the system operation, i.e., that the readings appear to be in the range that is expected for the survey area. This information is also included in the CSAZ program.

# US/UK World Magnetic Chart -- Epoch 2000 Inclination - Main Field (I)

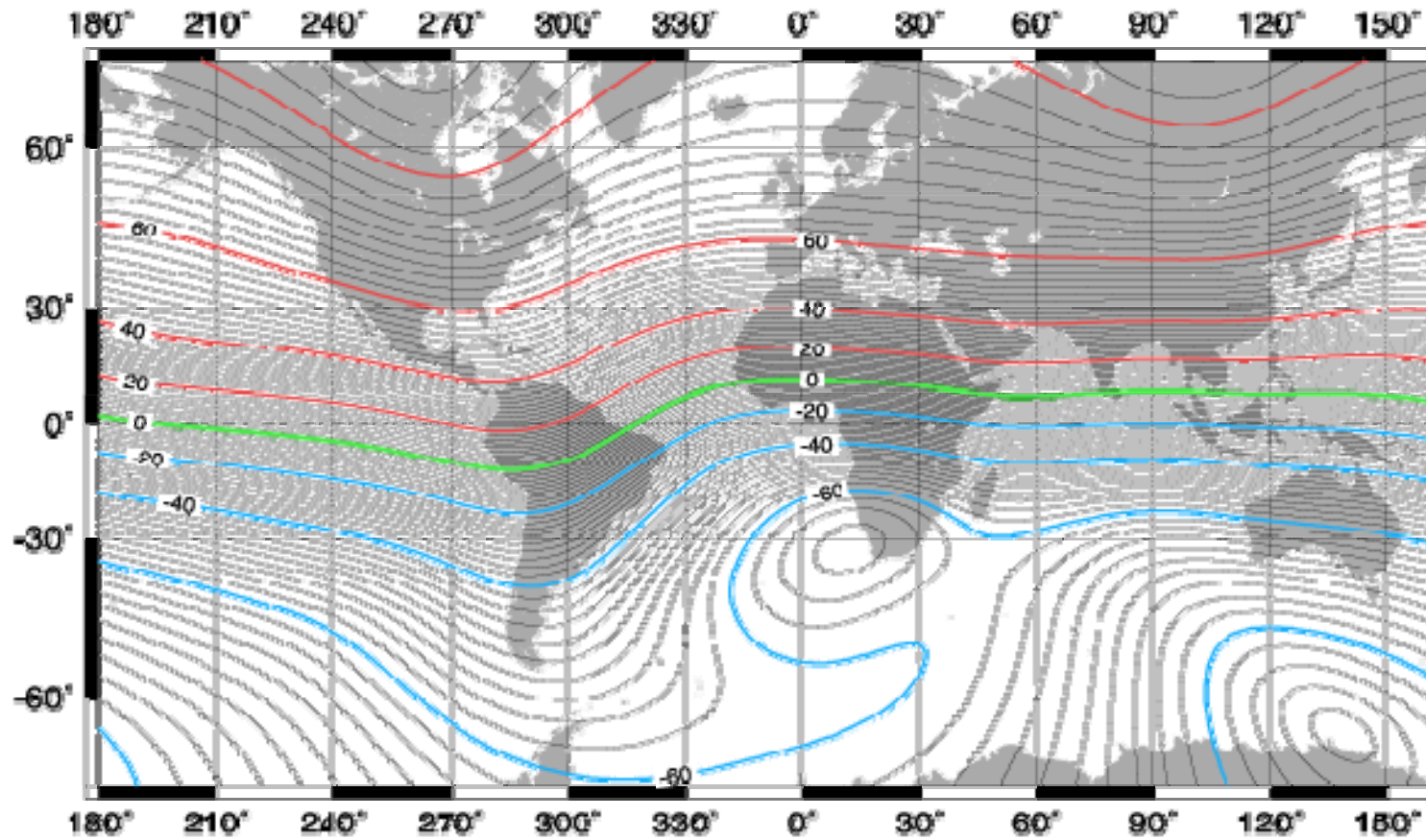

Units (Declination): degrees  
Contour Interval: 2degrees  
Map Projection: Mercator

Figure 35

# US/UK World Magnetic Chart -- Epoch 2000

## Total Intensity - Main Field (F)

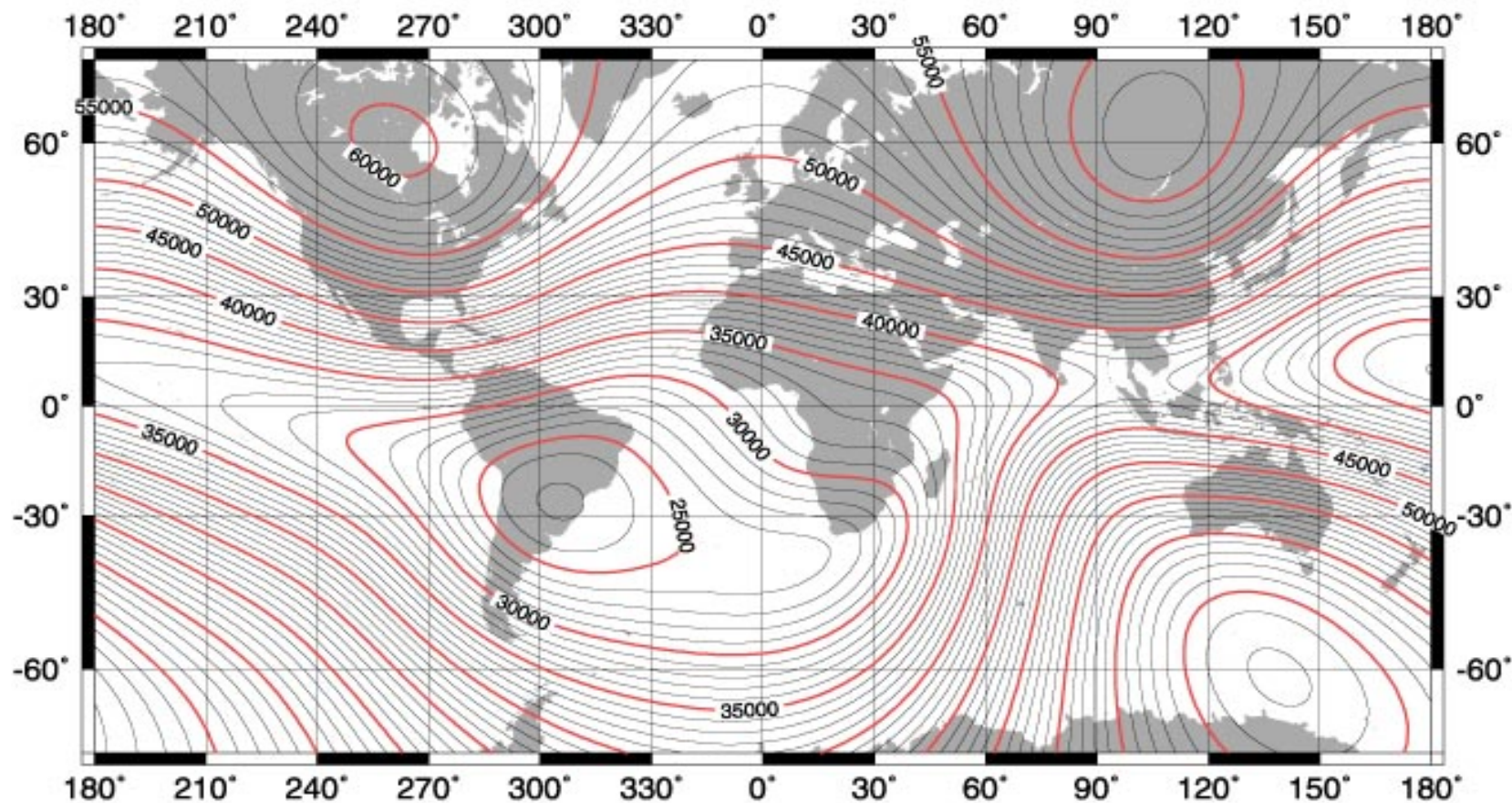

Units : nanoTeslas  
Contour Interval : 1000 nanoTeslas  
Map Projection : Mercator

Figure 36

## 4.4 CM-221 Counter Data Format and Command Structure

The CM-221 counter module is a counting device that converts the cesium Larmor signal (70 kHz to 350 kHz) into magnetic field strength in nano-Teslas (20,000 nT to 100,000 nT). In addition there are 5 external 12 bit A/D channels and 1 internal A/D channel that can be digitized and appended to the output data. A Julian clock string can be enabled and added to the output data stream as well. Finally there is an External Event pin that can be used for external trigger or event marking.

The output data format is programmable. For example each of the A/D channels can be added/removed from the output data stream by sending the appropriate commands. There are several other commands that are discussed in detail later in this document.

### 4.4.1 Output Format

Figure 13 shows the standard single counter configuration. Commands from the PC are sent out the RS232 transmit pin (TxD) to the counter. Mag and other data return on the receive pin (RxD).

Figure 37

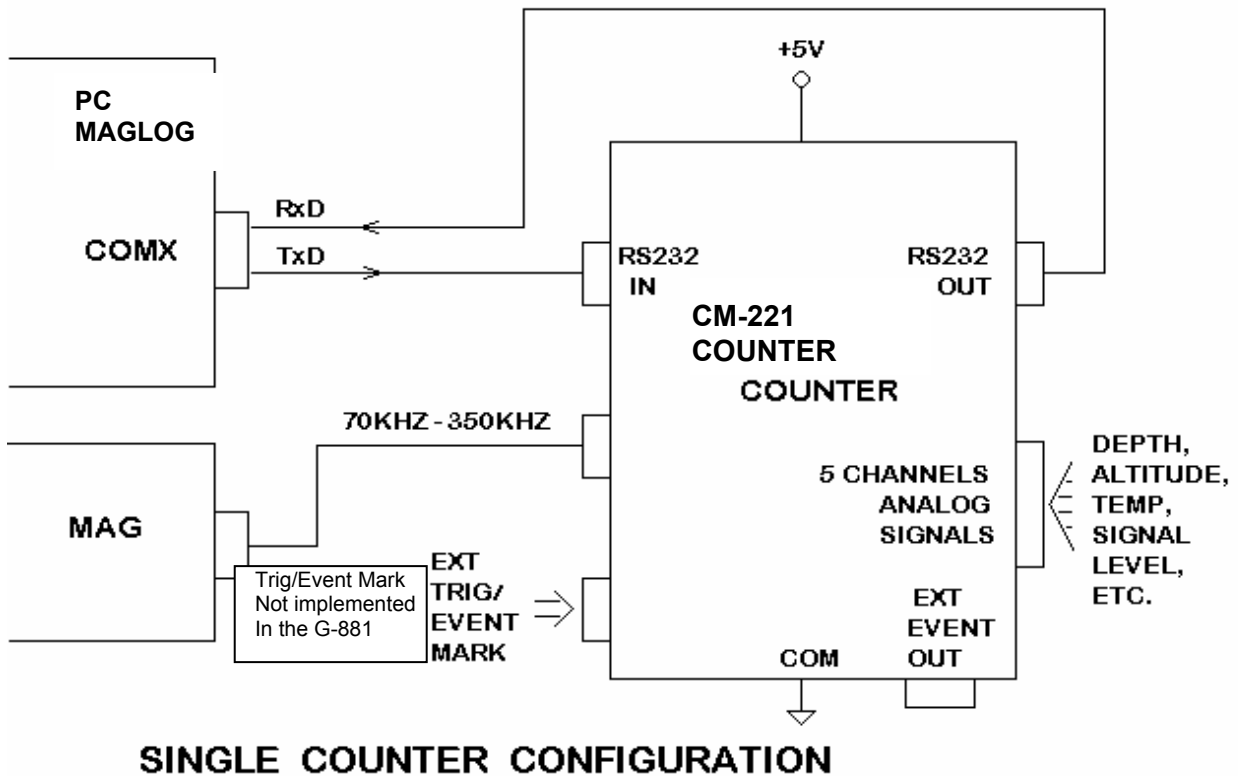

Upon power on the counter module defaults to its last saved setup as defined by the user using the UPDATE function described later.

Baud rate: 9600 baud, 8 data bits, no parity, 1 stop bit

Cycle rate: 10 Hertz

Analog channels: Channel 0 (Larmor signal level) enabled, depth and altitude Channels, when applicable, enabled, and channels 3-8 disabled.

Julian Clock: Disabled

Output Format: ASCII

The default output data stream contains all printable ASCII characters with each sample terminated with a carriage return/ line feed sequence. The following example illustrates this format where there are no depth or altitude analog channels enabled:

| <b>char #</b> | <b>description</b>   |
|---------------|--|
| 1             | An ASCII '\$' (marks first character of data stream)   |
| 2             | an ASCII '1' or a blank (depending on whether Mag reading is above or below _99999.999 nT).  |
| 3-7           | 5 digits of Mag data   |
| 8             | an ASCII decimal point ['.']   |
| 9-11          | 3 more digits of Mag data  |
| 12            | an ASCII comma [',']   |
| 13-16         | 4 digits of A/D channel 0 (9999 full scale, 0 to +5 volts in). This channel is internal and contains the signal level of the magnetometer. |
| 17            | an ASCII carriage return   |
| 18            | an ASCII line feed   |

If the data were captured to a file and then copied to a line printer the printout would look something like this:

```
$ 49895.131,1249  
$ 49895.376,1287  
$ 49995.517,1245  
$ 49995.293,1272  
$ 49995.835,1229  
$ 49995.071,1281  
$ 49995.159,1298  
$ 49995.508,1214  
$ 49995.216,1245  
$ 49995.347,1297
```

Counter modules can be daisy chained to form multiple sensor arrays as shown in Figure 14. Note that the output data from counter 0 goes into the input port of counter 1, and so on. This allows each counter module to append its output data onto the end of the data stream coming from the previous counter(s). As each counter receives data characters from previous counters they get echoed to the next. An exception to this is the carriage return/ line feed sequence. The carriage return is replaced by a comma and the line feed is ignored. Thus one long concatenated string from all counters is output from/through the last counter, and is terminated by a carriage return/ line feed sequence by the last counter only.

Note that only the first counter outputs a preamble character (the default character is '\$').



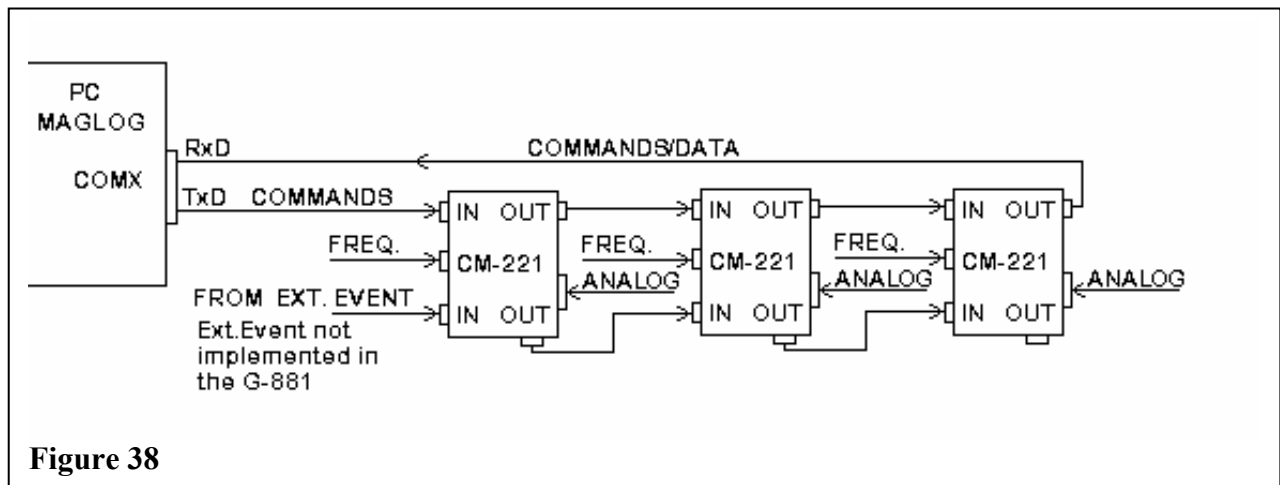

## MULTI-COUNTER MODULE CONFIGURATION

### 4.4.2 General Command instructions

Commands are sent into the input port of the first counter. Note that commands are the only characters that enter the first counter. A command string is stored in an incoming buffer until terminated by a carriage return. The command will then be executed at the end of the current sample, immediately after the last 'data' byte has been sent out the output port. Then the command will be echoed to the next counter (or back to the logging computer if it is the last/only counter in the chain).

Subsequent counter modules in multiple counter arrays differentiate between output data and commands by assuming that all characters between the data preamble character ('\$' is the default) and the next line feed are Data bytes from the previous counter(s). Commands only arrive at subsequent counters after the data transmission is complete. Each command is identified by the first character, followed by some number of operand characters and a carriage return.

Only one command can be sent at a time. After each command wait for the command echo before sending another.

All commands are terminated with a carriage return. A line feed may be sent as well, but it will be ignored by each counter module. However, at the end of every output data string there will be a carriage return and a line feed sent. This method insures that the final counter will have a carriage return/line feed sequence so that if the file is printed it will look correct on paper. By using the carriage return as the command terminator and stripping input line feeds insures that dumb terminals (and dumb terminal emulation software) can be used to control the counter output. (Dumb terminals do not normally transmit line feeds when <Enter> is pressed).

### 4.4.3 G-882 Quick Command list

This is a list of commonly used commands for the G-882 magnetometer. For a full list of commands and command options refer to the commands section of the manual (below).

#### Set Cycle time

C0100 <enter> sets the magnetometer to sample at 1 second intervals.

C0010 <enter> sets the magnetometer to sample at 0.1 second intervals.

Set A/D channels on/off for a single magnetometer (see full list for control of more than one magnetometer) '0' = turn off channel; '1' = turn on channel.

The G-882 has a total of 8 analog channels (0-7) plus magnetic field reading.

A11 turns on channel 1

A12 turns on channel 2

A13 turns on channel 3 (up to 8 analog channels)

A01 turns off channel 1

A02 turns off channel 2

A03 turns off channel 3 (up to 8 analog channels)

In a typical system they are designated as follows:

Magnetic field (always on)

Chan. 0 signal

Chan. 1 depth

Chan. 2 altimeter

Chan. 3 Brightness indicator

Chan. 4 RF effort indicator

Chan. 5 28 volts at magnetometer

Chan. 6 humidity inside magnetometer

Chan. 7 heater

Note: The depth, altimeter, and 28 volts need to have calibration coefficients applied to convert to feet, meters, or volts.

#### 4.4.4 G-882 Detailed Commands

Here are the current list of commands and the format of each:

| <b>Command</b><br>-----  | <b>Format:</b><br>-----  | <b>Description:</b><br>-----  |
|--|--|---|
| Set Cycle time   | Byte 1: 'C'<br>2: x<br>3: x<br>4: x<br>5: x<br>x: x<br>6/7: CR | Set time in 0.01 sec increments<br>MS digit of number ('0'-'9')<br>3S digit of number<br>2S digit of number<br>LS digit of number<br>5 MS optional char ('0' or '5')<br>carriage return                             |
| [Note: the 5 MS char is optional. It was added to allow setting the cycle time to more precision after the initial software release] |  |   |
| Set A/D ch's<br><br>221)   | Byte 1: 'A'<br>2: x<br>3: x<br><br>4: x<br>5: x<br>6: CR       | Enable/disable A/D channels<br>'0' = turn off channel; '1' = turn on<br>select channel #('0'-'7')('0'-'7' for CM-<br><br>MS digit of counter # ('0' or '1')<br>LS digit of counter # ('0' - '9')<br>carriage return |
| [Note: characters 4 and 5 can be omitted. If this is done the command will default to counter 0.]                                    |  |   |
| Change Baud Rate   | Byte 1: 'B'<br>2: x<br>3: x<br>4: x<br>5: x<br>6: x<br>7: CR   | Baud rate change command<br>MS char (1,0,0,0,0,0,0)<br>S char (9,9,4,2,1,0,0)<br>3S char (2,6,8,4,2,6,3)<br>2S char (0,0,0,0,0,0,0)<br>LS char (0,0,0,0,0,0,0)<br>carriage return                                   |

| <b>Command</b> | <b>Format:</b>                               | <b>Description:</b>  |
|----------------|--|--|
| Output Format  | Byte 1: 'O'<br>2: x<br><br>x: x<br><br>3: CR | select output format<br>format select:<br>'A'= ASCII (default)<br>'E'= excess 3<br>'P'= packed BCD<br>'S'= Sandia G822A fmt<br>'0' = Sandia single Mag<br>'1' = Sandia dual Mag<br>carriage return |

[Note: the '0' and '1' 3rd characters are valid only when selecting the Sandia format]

|                      |   |   |
|----------------------|---|---|
| Julian Clock Format: | Byte 1: 'O'<br>2: J<br>3: x<br>4: x<br>5: x<br>6: x<br>7: x<br>8: x<br>9: x<br>10: CR | select output format<br>format select:<br>Day field: '1'= on ; '0' = off<br>Hour field: '1'= on ; '0' = off<br>Min field: '1'= on ; '0' = off<br>Sec field: '1'= on ; '0' = off<br>10mS field: '1'= on ; '0' = off<br>MSB of counter # ('0' or '1')<br>LSB of counter # ('0' thru '9')<br>carriage return |
|----------------------|---|---|

[Note: characters 8 and 9 can be omitted. If this is done the command will default to counter 0.]

|                     |  |   |
|---------------------|--|---|
| Julian Time Enable: | Byte 1: 'J'<br>2: x<br>3: x<br>4: x<br>5: CR | Enable/Disable Julian time output<br>'0' = turn off; '1' = turn on<br>MS digit of which counter ('0','1')<br>LS digit of counter # ('0' - '9')<br>carriage return |
|---------------------|--|---|

[Note: characters 3 and 4 can be omitted. If this is done the command will affect all counters in the chain.]

|                 |  |  |
|-----------------|--|--|
| Set Julian Day: | Byte 1: 'D'<br>2: x<br>3: x<br>4: x<br>5: CR | Set the Julian day number<br>MS digit of number ('0'-'3')<br>2S digit of number ('0'-'9')<br>LS digit of number ('0'-'9')<br>carriage return |
|-----------------|--|--|

| <b>Command</b><br>----- | <b>Format:</b><br>-----                            | <b>Description:</b><br>-----  |
|-------------------------|--|---|
| Set Hour:               | Byte 1: 'H'<br>2: x<br>3: x<br>4: CR               | Set the hour<br>MS digit of number ('0'-'2')<br>LS digit of number ('0'-'9')<br>carriage return   |
| Set Minute:             | Byte 1: 'M'<br>2: x<br>3: x<br>4: CR               | Set the minute<br>MS digit of number ('0'-'5')<br>LS digit of number ('0'-'9')<br>carriage return |
| Set Second:             | Byte 1: 'S'<br>2: x<br>3: x<br>4: CR               | Set the second<br>MS digit of number ('0'-'5')<br>LS digit of number ('0'-'9')<br>carriage return |
| Find counters:          | Byte 1: 'F'<br>2: '0'<br>3: '0'<br>4: CR           | Find and assign counter numbers<br>assign first counter as # 0 (MSB)<br>LSB<br>carriage return    |
| Set Preamble            | Byte 1: 'P'<br>2: x<br>3: CR                       | Set the preamble char ('\$')<br>The desired character<br>carriage return                          |
| Jump to debug           | Byte 1: 'X'<br>2: 'B'<br>3: 'U'<br>4: 'G'<br>5: CR | first char of 'XBUG' string<br>2'cnd char<br>3'rd char<br>4'rth char<br>carriage return           |

| <b>Command</b> | <b>Format:</b>  | <b>Description:</b>  |
|----------------|---|--|
| Error echo     | Byte 1: 'E'<br>2: 'R'<br>3: 'R'<br>4: x<br>5: x<br>6: ':' | Syntax err - echo 'ERR' + counter #<br>2'cnd char<br>3'rd char<br>MS digit of counter number ('0'-'1')<br>LS digit of counter number ('0'-'9')<br>colon delimits error message cmd |

[Note: xxx: bad command string is echoed in the following characters, followed by a ...  
x: CR carriage return]

|                    |  |  |
|--------------------|--|--|
| Reset              | Byte 1: 'R'<br>2: 'E'<br>3: 'S'<br>4: 'E'<br>5: 'T'<br>6: CR | Reset the microprocessor<br>2'cnd char<br>3'rd char<br>4'th char<br>5'th char<br>carriage return   |
| Interrogate Setup: | Byte 1: 'I'<br>2: x<br>3: x<br>4: x<br>5: CR                 | Interrogate command<br>item select:<br>'A'= Analog output fields selected<br>'J'= Julian Clock fields selected<br>'V'= software version number.<br>MS digit of counter number ('0'-'1')<br>LS digit of counter number ('0'-'9')<br>carriage return |

[Note: Characters 3 and 4 are optional. If they are omitted the command will return the output from counter 0.

#### 4.4.5 Update Default Parameters

Your magnetometer has been supplied with a default parameter update function. This means that you may change the operational parameters (baud rate, cycle time, number of analog channels turned on) and then save that configuration in the processor non-volatile memory so that the next time the magnetometer is started, these parameters are loaded. Once the configuration is set by the user, and the user determines he or she would like to save this configuration, the UPDATE command is sent by the MagLogLite or MagLog program via the CM201CFG.EXE program. The CM201CFG is placed on the computer desktop when the MagLogLite or MagLog program is installed and is available to check or change the magnetometer configuration and store the values in non-volatile

memory. Clicking on the STORE CONFIGURATION (lower left button) sends the proper commands to the magnetometer counter board(s).

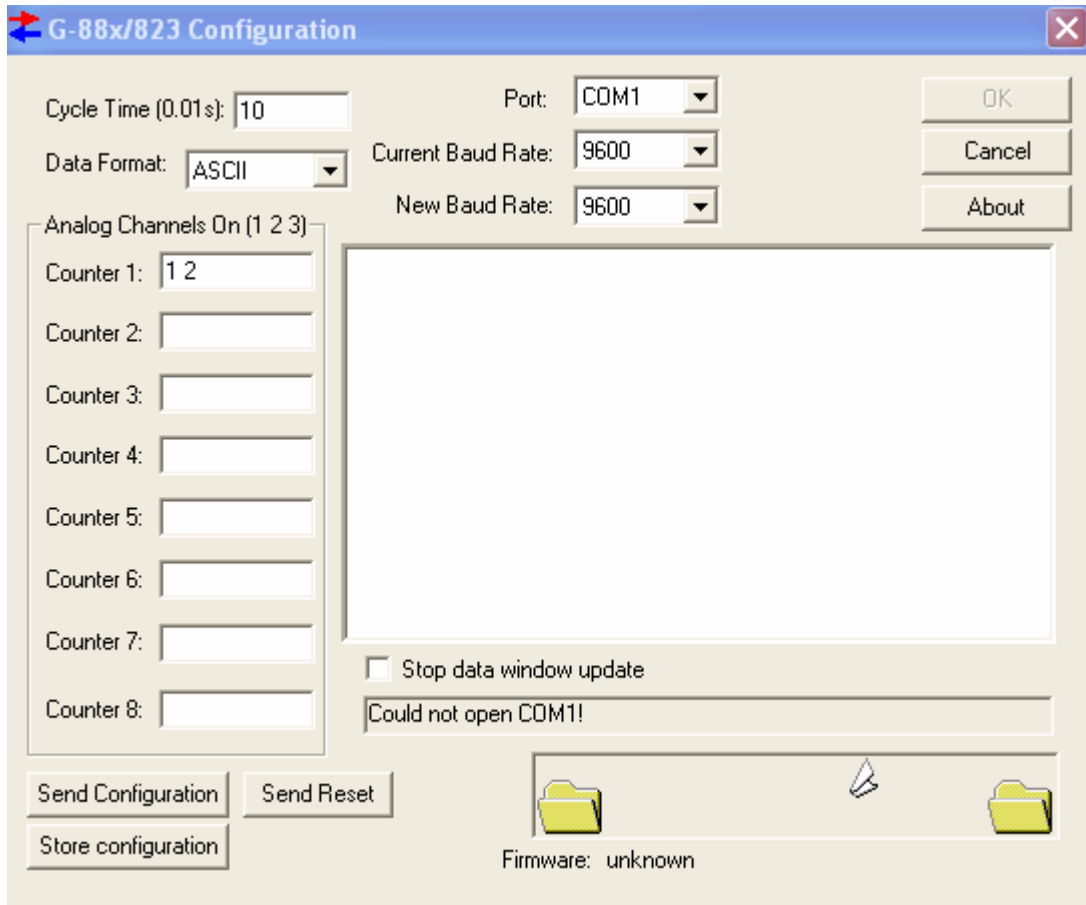

**Figure 39**

Alternately the user may store the configuration manually using a terminal emulator such as Hyperterminal by entering the following commands:

|        |      |        |                             |
|--------|------|--------|-----------------------------|
| Update | Byte | 1: 'U' | Update operation parameters |
|        |      | 2: 'P' | 2 <sup>nd</sup> character   |
|        |      | 3: 'D' | 3 <sup>rd</sup> character   |
|        |      | 4: 'A' | 4 <sup>th</sup> character   |
|        |      | 5: 'T' | 5 <sup>th</sup> character   |
|        |      | 6: 'E' | 6 <sup>th</sup> character   |
|        |      | 7: CR  | carriage return             |

[Note: If it is desired to permanently save any changes to the operation parameters that may have been made, sending an UPDATE command before powering down will save them. The next time the system is powered-on the new, saved parameters will be used.]

The addressed counter will insert characters into the command string just before the carriage return before echoing to subsequent counters. See detailed command description for format and definition of these added characters.

#### **4.4.6 Command Set Descriptions**

##### **Cycle Time Set:**

Cycle time is set by transmitting the number of 0.01 second increments needed to make the desired output rate. The default rate is 10 hertz (C0010). To set the output rate to 1.2 seconds the command string would be "C0120".

After the initial software release another character was added to allow the cycle time to be set to 5 ms resolution. To maintain compatibility with older versions this character is optional. For an example on using this extra precision, the command "C00125" would set the cycle time to 8 hertz (125 ms).

##### **A/D channel select/enable:**

Three pieces of info are needed to select and turn on/off an A/D channel: The counter #, the channel number, and a flag indicating whether to enable or disable that channel. The enable/disable flag is sent first (after the 'A' command identifier). A '0' character will turn off the channel, a '1' turns it on. The next character specifies the channel number (0-5 for CM-201 or 0-7 for CM-221), followed by 2 characters indicating the counter number (00-19). If the counter number is not sent then it defaults to counter 0.

##### **Baud Rate Change:**

The baud rate can be commanded to change by giving a 'B' command character followed by 5 more number characters specifying the desired baud rate. Valid baud rate commands are: 'B19200', 'B09600', 'B04800', 'B02400', 'B01200', 'B00600', and 'B00300'. This command will not execute until the entire command has finished echoing out to the next counter/logging device. This allows the command to propagate through all counters and be implemented before output data arrives at a different rate.

##### **Output Format Select:**

The default (ASCII) output format is described in detail at the beginning of this document. This is the easiest format to view and import into various processing utilities. It is also very inefficient in terms of disk storage space and time required



to transmit each cycle. There are three other output formats that can be used as well:

**Packed BCD:**

Packed BCD format throws away all commas, decimals, spaces, and the magnetometer most significant byte ('1' if more than 100,000 nT, or a blank is less than 100,000nT). The Preamble character is left alone. In addition all numeral characters (ASCII codes 30 hex through 39 hex) have the upper nibble (always a 3) discarded and two lower nibbles combined to form one byte. Finally, the carriage return, line feed sequence is replaced with a single terminating character '\*' (2A hex).

It is very difficult to show what these files would look like if displayed on a computer screen since each type of computer would display these binary characters differently. Many of these binary characters would be interpreted as screen commands which might ring the bell or clear the screen. Therefore it is necessary to convert ASCII printouts to hexadecimal numbers to show the Packed BCD format.

An ASCII counter output of:

'\$ 54369.127,1234,5678,0000'(plus carriage return line feed)

converted to hexadecimal numbers would be:

```
24 20 35 34 33 36 39 2E 31 32 37 2C 31 32 33 34
2C 35 36 37 38 2C 30 30 30 30 0D 0A
```

['\$' = 24, ' ' = 20, '.' = 2E, ',' = 2C, CR/LF = 0D 0A,  
'0'-'9' = 3x (where x = number 0-9)]  
Note: ' ' signifies a blank

Using the above definition the same data in packed BCD output format would be:

```
24 54 36 91 27 12 34 56 78 00 00 2A  
 \   \          \   \   \   \   \   \   \__Terminating character ('*')  
  \   \          \   \   \   \   \   \__analog channel #3 ('0000')  
   \   \          \   \   \   \   \   \__analog channel #2 ('5678')  
    \   \          \   \   \   \   \   \__analog channel #1 ('1234')  
     \   \          \   \   \   \   \   \__Mag reading ('54369.127')  
      \   \          \   \   \   \   \   \__Preamble Character ('$')
```

Note how easy it is to see the numbers if viewing a hex dump of the data. Remember though that it must be translated to printable characters before copying the raw data to printers or a CRT screen.

Commands that are echoed through the counter chain are received and sent as unmodified ASCII strings. Thus all commands will appear in the binary data set after the next '\*' data terminating character and will be terminated itself by a carriage return line feed sequence. Binary transmission then resumes with the next sample.

### **Excess 3 format:**

Excess three format is very similar to packed BCD. In fact the only difference is that each byte has 33 hex added to it after converting to Packed BCD. The reason for adding 33 hex to each packed BCD number is to avoid some difficult pitfalls with Packed BCD:

Packed BCD is a very common format but has many potential problems that can arise. ASCII digits are combined to form bytes with hexadecimal values in the control character range (less than 20 hex) which must be handled very carefully by the logging program. Examples of these characters include the Ctrl-S and Ctrl-Q software handshake controls (11 hex and 13 hex), the bell character (Ctrl-G, 07 hex), and the ASCII null (Ctrl-shift-@, 00H). Most terminal emulation programs can be configured to handle these characters as data instead of commands, but this is not the way the typical default configuration is set up.

Packed BCD eliminates this by shifting all numbers up by 33 hex. This moves all possible output values out of the control character range. It also makes them printable to a screen or printer without bells, beeps, screen clears, form feeds, etc. However they will still look like gibberish without translation.

### **Sandia/G822A format:**

This is a printable ASCII format that mimics the output from a one or two channel G822A magnetometer. Its output is limited to one counter module, with the Mag and signal level values as the only data being sent out. The Mag reading is preceded with an 'A' followed by 10 characters of ASCII Mag data. The G822A format sometimes has a second Mag reading following the first which is preceded with an ASCII 'B'. If selected the CM-221 counter places the signal level in the first 4 significant characters of the second Mag data slot. The sample is terminated by a carriage return line feed sequence.

The purpose of this format is to allow customer with existing G822A Sandia logging software to be able to use the CM-221 without upgrading to new logging software.

The single channel Sandia format is selected with the command string "OS" or "OS0". The dual channel output is selected by the command string "OS1".

**Example outputs:**

This is the ASCII output example from earlier, but with 3 A/D channels:

```
-----  
$ 49895.131,1249,0004,0005  
$ 49895.376,1287,0003,0007  
$ 49995.517,1245,0003,0006  
$ 49995.293,1272,0005,0006  
$ 49995.835,1229,0004,0005  
$ 49995.071,1281, 0006,0006  
$ 49995.159,1298, 0003,0007  
$ 49995.508,1214,0004,0007  
$ 49995.216,1245,0004,0004  
$ 49995.347,1297,0003,0005
```

Similar data displayed in hexadecimal:

```
-----  
24 20 39 39 37 37 38 2E 31 33 31 2C 33 37 34 39  
2C 30 30 30 34 2C 30 30 30 35 0D 0A 24 20 39 39  
38 39 30 2E 33 37 36 2C 33 36 38 37 2C 30 30 30  
33 2C 30 30 30 37 0D 0A 24 20 39 39 39 35 35 2E  
35 31 37 2C 33 35 34 35 2C 30 30 30 33 2C 30 30  
30 36 0D 0A 24 20 39 39 39 39 38 2E 32 39 33 2C  
33 34 37 32 2C 30 30 30 35 2C 30 30 30 36 0D 0A  
24 31 30 30 30 37 38 2E 38 33 35 2C 33 33 32 39  
2C 30 30 30 34 2C 30 30 30 35 0D 0A 24 31 30 30  
30 33 32 2E 30 37 31 2C 33 33 38 31 2C 30 30 30  
36 2C 30 30 30 36 0D 0A 24 20 39 39 39 37 39 2E  
31 35 39 2C 33 34 39 38 2C 30 30 30 33 2C 30 30  
30 37 0D 0A 24 20 38 36 37 37 38 2E 35 30 38 2C  
33 35 31 34 2C 30 30 30 34 2C 30 30 30 37 0D 0A  
24 20 37 38 37 37 38 2E 32 31 36 2C 33 36 34 35  
2C 30 30 30 34 2C 30 30 30 34 0D 0A 24 20 36 39  
39 37 38 2E 33 34 37 2C 33 37 39 37 2C 30 30 30  
33 2C 30 30 30 35 0D 0A
```

Similar data in Packed BCD format:

-----

```
24 99 77 81 31 37 49 00 04 00 05 2A 24 99 89 03
76 36 87 00 03 00 07 2A 24 99 95 55 17 35 45 00
03 00 06 2A 24 99 99 82 93 34 72 00 05 00 06 2A
24 00 07 88 35 33 29 00 04 00 05 2A 24 00 03 20
71 33 81 00 06 00 06 2A 24 99 97 91 59 34 98 00
03 00 07 2A 24 86 77 85 08 35 14 00 04 00 07 2A
24 78 77 82 16 36 45 00 04 00 04 2A 24 69 97 83
47 37 97 00 03 00 05 2A
```

Similar data in Excess 3 format:

-----

```
57 CC AA B4 64 6A 7C 33 37 33 38 5D 57 CC BC 36
A9 69 BA 33 36 33 3A 5D 57 CC C8 88 4A 68 78 33
36 33 39 5D 57 CC CC B5 C6 67 A5 33 38 33 39 5A
57 33 3A BB 68 66 5C 33 37 33 38 5D 57 33 36 53
A4 66 B4 33 39 33 39 5D 57 CC CA C4 8C 67 CB 33
36 33 3A 5D 57 B9 AA B8 3B 68 47 33 37 33 3A 5A
57 AB AA B5 49 69 78 33 37 33 37 5D 57 9C CA B6
7A 6A CA 33 36 33 38 5D
```

Similar data displayed in dual channel Sandia/G822A ASCII format:

-----

```
A9977813100B3749000000
A9989037600B3687000000
A9995551700B3545000000
A9999829300B3472000000
A0007883500B3329000000 (Note how the most significant '1'
A0003207100B3381000000 is truncated for readings greater
A9997915900B3498000000 than 100,000 nT).
A8677850800B3514000000
A7877821600B3645000000
A6997834700B3797000000
```

The same data in single channel Sandia format (ASCII):

A9977813100  
A9989037600  
A9995551700  
A9999829300  
A0007883500  
A0003207100  
A9997915900  
A8677850800  
A7877821600  
A6997834700

### **Julian Time Set:**

The Set Time commands (D,H,M,S) will initialize the time in all counter modules. If a particular counter has all Julian clock fields enabled the output string will have the following inserted after the last A/D channel and before the CR/LF:

,DxxxHxxMxxSxx\_xx

The x's would be ASCII characters (0-9) as required. The time registers are not incremented until enabled with the 'J1xx' command, so they can be set up then synchronized by sending the enable command at the correct time.

In Packed BCD and excess format the letters D,H,M,S, and \_ are stripped and the data encoded as per the Mag data above. The Day info is put into 2 bytes with the most significant nibble of the most significant byte set to zero.

### **Julian Time Enable:**

This command starts/stops the Julian clock. To start the clock on counter 0 the command would be "J100". "1" turns on the clock, while the "00" selects counter 0. To turn off the clock update on counter 2 the command would be "J002".

If the counter number information is omitted the command will affect all counter in the chain. Thus the command "J0" will turn off the update for every counter.

Note that the "Jxxx" command only affect whether the clock increments with time. It has no effect on whether or which clock fields are output. The "OJxxxxxyy" commands selects which field are output.



### **Echo Error command:**

This is not really a command but a message. If a command string is incorrectly sent or garbled the counter receiving it will change it to 'ERRxx' before echoing it to the next counter. 'xx' specifies the counter number where the syntax error first occurred. This error message is interpreted as a command by subsequent counters which echoes the string unchanged.

### **Interrogate Setup command:**

This command allows the operator or logging software to identify which analog channels and Julian clock fields are being output via the serial port. This information is used to verify output fields with their hardware channels, and to allow automated calculation of data field position within each sample being sent out. In addition the software revision number can be interrogated.

The first character 'I' designates the interrogate command, the second letter designates which item to interrogate. 'A' specifies interrogating the analog channels, 'J' specifies the Julian clock, and 'V' specifies the software revision number.

The next two characters specify the counter number '00' through '19'. If the counter number is omitted, counter 0 will respond.

The addressed counter will insert a response into the command string before sending echoing it out the serial port to the display terminal or subsequent counter modules. Subsequent counter modules will ignore these extra response characters and pass them unmodified down the chain. The response format for each of the three interrogate items are detailed in the examples below:

#### **Analog channels:**

The command "IA01" will command counter number one to output characters indicating which of the six analog channels have been selected for output. Counter 1 will modify the command string to "IA01:abcdef" where the letters a-f are either an ASCII '0' (channel off) or '1' (channel on) corresponding to channels 0-5 respectively. If analog channel 0,3, and 4 were selected on counter 1 the echoed command string would be "AI01:100110" followed with a carriage return line feed.

#### **Julian Clock:**

The command "IJ" will command counter 0 to output which Julian clock fields have been selected for output (note that the two digit counter number was not specified, so counter 0 responds by default). Counter 0 will modify

the command string to "IJ:abcde" where the letters a-e would be replaced with an ASCII '0' (field off) or '1' (field on). The five output fields are:

- a: Julian day
- b: Hour
- c: Minute
- d: Second
- e: Fractional Seconds (to 10 milliseconds)

If counter 0 had all clock fields selected for output except the Julian Day it would modify the command string to "IJ:01111" followed with a carriage return line feed.

Software Version Number:

The command "IV02" will command counter 2 to send its two character software version number. Counter 2 would change the command string to "IV02:xx" where xx is the version number of the software. If Counter 2 was software version "A4" then the echoed command string would be "IV02:A4" followed by a carriage return line feed.

#### **Reset command:**

If the command 'RESET' is sent to the counter a power up reset will occur initializing all parameters to default. The reset sequence will not start until the reset command has finished echoing out the RS232 port to the next counter/logging device. This allows each device down the chain to reset in sequence.

#### **Update command:**

If the command 'UPDATE' is sent to the counter, any parameters that were changed, will be saved and be the default parameters the next time the system is powered on. This command must be sent before powering down of the changes will be lost.

#### **Jump to debug:**

If the command string 'XBUG' is received the counter will do a one way jump to factory debug mode where a rudimentary operating system allows probing of registers, ports and memory for debugging purposes. It will only function properly with a single counter module (no daisy chained counters).

#### **4.4.7 Power-up Initialization**



By default all counters will wake up thinking that they are counter #0 and begin to output data at the default 10 hertz rate or as set by default parameters in flash memory. This data will appear as a synchronization command to subsequent counters and will cause a brief adjustment period until each counter determines where it stands in the daisy chain. Thus there will be a short period of garbled transmissions to the logging PC upon power-up or reset.

## **4.5 Accessory Software**

### **4.5.1 Cesium Sensor Active Zones – CSAZ**

A newly designed CSAZ Windows™ program is available on our Magnetometer CD and from our FTP site at <ftp://geom.geometrics.com/pub/mag/Software/> (look for csaz-setup.exe). Please read the manual that is included with the program for complete instructions on how to use the CSAZ program for worldwide inclination and sensor orientation solutions.

### **4.5.2 CM201**

Note: Cm201 and View201 are DOS software and compatible with CM-221 counters. They are installed from the Magnetometer CD under Utilities. Some modern computers may not run these DOS programs correctly.

Cm201 is a program that facilitates sending a command start-up file to the G-882 counter(s) and initiating system operation. The program is executed by typing “cm201” at the DOS prompt and pressing return. Cm201 expects a counter command file that must be called Cm201go.cnf. This file is a list of counter commands, each followed by a carriage return that may be required to configure the counter to your application.

This software and all its necessary files may be installed on your system by placing the Install disk in either your a: or b: floppy drive, switching to that drive, typing “install” at the DOS prompt and pressing return. Install will ask a number of questions to which you should respond to configure the CM-221 counter to your system and create the Cm201go.cnf file.

If, after installing Cm201, if further commands are required (such as CLOCK) to configure CM-221 operation to your application, they may be added to the Cm201go.cnf file by editing this file with any suitable text editor.

The following describes Cm201 and the files that will be installed on your C: drive:

#### **Install.bat**

This is a batch file used to copy the contents of the Utility Software onto your hard disk. A directory called "GeoUtil" is created on the "C" drive and then all of the files are copied into that directory. After the files are copied, this batch file then runs Cm201set.bat

### **Cm201Set.bat**

This batch asks the user questions and based on the answers to these questions creates a batch file called "Cm201.bat". The questions include such things as, to which COM port the CM-221 counter is connected.

### **Cm201.bat**

This batch file is created by Cm201set.bat. It invokes Cm201go.exe to send any command lines necessary to correctly configure the CM-221 counter(s) for the users application.

### **Cm201go.exe**

This program is intended to send any commands to correctly configure the CM-221 counter module(s). Normally the commands are taken from the file Cm201go.cnf, but this can be overridden if needed.

The calling syntax for this program is:

```
Cm201go FileName.cnf /b:BBBBB /p:P /i:I /d:D
```

Where:

- |       |   |
|-------|---|
| BBBBB | Is the baud rate that the CM-221 starts at. Normally this is 9600.  |
| P     | The port number /p:1 would mean use COM1. This parameter is optional. If it not specified COM1 will be used.                                  |
| I     | The interrupt number to use. This parameter is optional. If it is not specified the normal interrupt for the COM port is used.                |
| D     | Any value other than zero will turn on the debugging display. This parameter is optional. If it is omitted the debugging display is disabled. |

The contents of the Cm201go.cnf file are sent line by line to the CM-221 counter module(s). After each line is sent the CM201go program waits for the confirmation that the command was received correctly. If the confirmation is not received the line is repeated. For lines that change the CM-221's baud rate

the Cm201go program changes its baud rate as required. If the input line has the special code "[CLOCK]" on it, the CM-221's clock will be set to match that of the PC.

A typical Cm201go.cnf would be:

```
[CLOCK]
c0010
oj11111
```

### **Commflip.exe**

Given the port numbers of two COM ports this program will exchange their addresses. On some note book computers this is needed to be able to use some software.

### **batmenu.exe, drawbox.exe, gotoxy.exe, yymmdd.exe, foreach.exe, getkey.com**

These programs are utility programs that allow the batch files to interact with the user.

### **4.5.3 View201 Lab Display Software**

View201 is a program that enables programming and viewing the magnetometer and analog data from one to three CM221 counter modules. It was written primarily as a factory debug/test utility and is provided as a tool to help installation and testing of the counter(s) in the field. The output can be viewed in both raw text and in graphics mode. In addition the output data can be logged to disk if desired. The program defaults to using Com port #1, although Com port #2 can be used by adding "/COM2" to the command line after "View201".

Upon startup the program listens to the output data stream from the counter(s) and synchronizes to the output baud rate. The raw output data is then displayed in a data text window. Along the top is a status bar showing the condition of the serial port and the serial input buffer.

View201 defaults to using COM port #1. COM port #2 can be selected by typing "View201 /COM2" and <ENTER> at the DOS prompt.

After the magnetometer has warmed up the first comma delimited field should be showing a stable magnetometer reading. The default counter output format includes the 4 character signal level in the next field (9999 full scale). Other data may be present as well depending on output configuration. If more than

one magnetometer is daisy chained together there will be other magnetometer data field embedded in the output stream.

Commands can be sent to the counter module(s) at anytime. There are many commands that control the CM-221 which are detailed in the magnetometer manual. As an example, the command "A0000" followed by a carriage return turns off analog channel 0 (signal level) in counter 00: Each character is sent as it is typed and stored by the counter. When a carriage return is received by the counter the command is executed and then echoed down the daisy chain of counters until it is received back by the View201 program and displayed in the data window. A correctly echoed command string is a confirmation that the command was received and executed properly. Mis-typed or invalid commands will be turned into an error message and echoed through to the View201 display window. (Type A1000<return> to turn the signal level channel back on).

The magnetometer data can be viewed in graphics mode by pressing the <F5> function key. View201 defaults into displaying the magnetometer data from counter #0 at 10 nT full scale. Data from the second and third magnetometer can be displayed by pressing <F2> and <F3> respectively. If magnetometer 2 or 3 are not present the data fields are set to zero.

Data can be logged to disk at any time by pressing <F10>. A filename is created based on date and time and logged to disk. A logging message is displayed and a low frequency beeper plays to indicate that logging is taking place. Pressing <F10> again stops the logging process.

Currently, View201 only recognizes the ASCII output format. This is the default output format, but there is nothing preventing a change format command from being sent to the counter module. If the output format is changed the View201 program will cease to function correctly.

A list of function keys and their use can be viewed at anytime by typing a question mark (?).

Following is a description of each View201 function key. These are all functions that control the operation of the View201 program and should not be confused with commands that affect the counter module:

#### **4.5.3.1 Function Keys**

<F1> = Toggle graphics display of Mag1 on/off. Default setting is on.  
This key has effect in graphics mode only.

<F2> = Toggle graphics display of Mag2 on/off. Default setting is off. If turned on and no magnetometer#2 is present the magnetometer 2 data value is forced to zero. This key has effect in graphics mode only.

<F3> = Toggle graphics display of Mag3 on/off. Default setting is off. If turned on and no magnetometer#3 is present the Mag3 data value is forced to zero. This key has effect in graphics mode only.

<Alt F1> = Toggle graphics display of Grad1 on/off. Gradient channel 1 is the difference between Mag1 and Mag2. This key has effect in graphics mode only.

<Alt F2> = Same as <Alt F1> except it applies to Grad2 channel.

<Alt F3> = Same as <Alt F1> except it applies to Grad3 channel.

<Shft F1>= Change graphics display color for Mag1. Press this key several times to cycle through the 16 colors available for displaying mag1.

Note that the display indicator for Mag 1 in the lower left hand corner of the graphics display changes as well, aiding in identifying which trace belongs to which variable. This key only has effect in graphics mode.

<Shft F2>= Same as <Shft F1> except it applies to Mag2 channel.

<ShftF3> = Same as <Shft F1> except it applies to Mag3 channel.

<Ctl F1> = Change graphics display color for Grad1 trace. Press this key several times to cycle through the 16 colors available for displaying Grad1. Note that the display indicator for Grad1 in the lower right hand corner of the graphics display changes as well, aiding in identifying which trace belongs to which variable. This key only has effect in graphics mode.

<Ctl F2> = Same as <Ctl F1> except it applies to Grad2 channel.

<Ctl F3> = Same as <Ctl F1> except it applies to Grad3 channel.

<F4> = Toggle between true and normalized gradient display. When measuring gradients it is often desirable to center the display trace to the center of the screen so that small variations do not cause screen wrapping. Pressing F4 will calculate and add an offset value to force the gradient display traces to the center. Pressing F4 again will toggle back to absolute display mode. Note that the Grad display indicators in the lower right hand corner of the

graphics display screen change from "Gradx" to " "GradZx" indicating the current mode. Note that this normalizing only takes place on gradient channels.

- <Alt F4> = Toggle true and normalized w. offset grad display. When measuring gradients with all three gradient channels turned on it is often desirable to move the three gradient traces close to the center of the display - but not place them right on top of each other. This key works the same as F4 above but leaves the traces slightly offset from one another.
- <F5> = Toggle between graphics and text display mode.
- <F6> = Lower the magnetometer full scale coefficient in the graphics display window. This key only affects the Mag channels (not gradient).
- <F7> = Raise the magnetometer full scale coefficient in the graphics display window. This key only affects the Mag channels (not gradient).
- <Alt F6> = Lower the Grad full scale coefficient in the graphics display window. This key only affects the Grad channels (not magnetometer).
- <Alt F7> = Raise the Grad full scale coefficient in the graphics display window. This key only affects the Grad channels (not magnetometer).
- <F8> = Clear next graphics screen and jump to it.
- <F9> = Clear Break, Frame, and Parity errors in the Com port status bar (text display screen only).
- <ALT F9>= Auto adjust to incoming baud rate and clear errors.
- <F10> = Toggle logging to disk.
- <Esc> = Exit to text mode (if in graphics display mode). Exit to DOS (if text mode and not logging to disk).

#### 4.5.3.2 Displaying Analog Channels

When in graphics display mode [F5] up to six analog channels may be enabled by typing <CTRL A>. This will activate a series of questions to format the analog data for display:

**Display Channel Number [0-5]:**

Selects one of six display channels. Any channel can be selected. The default number is the first unused display channel. If a channel currently in use is selected all subsequent menu items will have their default values set to the current values. This makes it easy to modify the format of a channel currently being plotted by simply pressing <enter> until the parameter to modify is reached.

**Display channel ON/OFF [0/1]:**

Type '0' to turn a channel off. No further menu parameters will follow and the channel will stop plotting. Type '1' to turn the display channel on or just <ENTER>, which defaults to on.

**Counter Number [0-2]:**

Selects which counter the analog data will come from. Up to three daisy chained counters may be logged by this program. The default is always counter 0 (the first [or only] counter).

**Analog Channel Number [0-5]:**

Selects which A/D channel of the above counter is to be displayed.

Note:

1) Do not confuse "analog channel number" with "display channel number" above. They are not related in any way. Think of the display channels as 6 separate input channels to a 6 channel analog strip chart recorder. The counter channel numbers (along with counter number information) specify a particular analog information channel. With three counters there could be 18 separate information channels - anyone of which could be configured to any display channel. In fact one analog channel could be assigned to two display channels with differing full scale coefficients - allowing a course and fine graphics display of the same channel.

2) This program does not know which analog channels are actually coming out of the counter. It is possible, for example, for the counter to be commanded to output channels 0, 4, and 5 only.

This program sees only three analog channels in the counter's data stream and will refer to them as channels 0,1, and 2.

### **Unipolar/Bipolar [U/B]:**

As described in the magnetometer/counter manual there are 4 unipolar (including the signal level) [0 to +4.096 volts], and 2 bipolar channels [ $\pm$  2.048 volts]. This parameter is used to signify which type of analog channel this is.

### **Clip/Wrap [C/W]:**

This parameter specifies what to do when the analog data exceeds the full scale setting (see next paragraph). Clip mode causes the data to be clipped at full scale so that the channel traces the top of the display screen (or possibly the bottom of screen in bipolar mode). Wrap allows the trace to over-scale and wrap back around to the bottom or top of the screen.

### **Full Scale Set:**

Set the full scale value of the display using the "+" and "-" keys. Note that a value of 10000 nT FS display as "0000" full scale. All other values display correctly in the allocated 4 digits.

### **Label:**

This allows a 10 character label to be associated with the analog channel. These labels make it easy to identify what each trace is at a glance by looking at the label (which is printed at the top of the screen) and correlating the label's color to the matching display trace color. To erase the default label of "channel n" use the backspace key, then enter a new one.

### **Set trace color:**

Use the "+" and '-' keys to cycle through all the possible trace colors using the label name entered above as a guide.

After the above data have been entered, the display channel will be plotting. At the top of the screen all of the activated display channels are documented in the same color as their associated trace color as in the following example:

```
Pitch
A13±1000C
```

The display channel in this case was labeled "Pitch". Underneath it is a shorthand display of all the setup parameters:



- "A" : signifies this is an analog channel.
- "1" : the counter number [0-2]
- "3" : the counter channel number [0-5]
- "±" : Bipolar mode, would have been set to "-" for unipolar
- "1000" : Full scale value. If "0000" is displayed it mean "10000" full scale.
- "C" : Clipped display, would be a "W" for wrap mode.

At the right edge of the screen are two normalized scales for the analog data. One scale is for unipolar analog channels [0-100%], and the other is for bipolar channels [± 50%].

#### **4.5.4 Depth Cal**

This program is intended for use only if you purchased logging software other than MagLog-Lite™ or MagLog™ from Geometrics that might allow calibration of the depth sensor by determining a bias and scale factor. For additional automatic depth calibration, see Depth Calibration using MagLog-Lite™ or MagLog™ in section 4.5.5 of this manual.

The Depthcal.exe program provides BIAS and SCALE values for entry into logging software to calibrate the depth sensor. This program was installed in C:\GEOUTIL on your hard drive when you installed the Utility software.

DepthCal is an independent program (you may need to exit the logging software to use it) that will lead you through an experiment with your G-882 to derive the BIAS and SCALE values. To execute, at the DOS prompt in C:\GEOUTIL, type DEPTHCAL and press the Enter key. The questions that you answer will guide you through a simple experiment and then calculate the BIAS and SCALE values.

#### **Bias and Scale Factors Explanation and Calculation:**

The depth transducer provides full scale readings of '9999' regardless of whatever there range may be.

The DepthCal program supplied on the Magnetometer CD under Utilities may be used to calculate the bias and scale factors for the depth transducer as explained below.

The DepthCal program assumes that the logging software has initial settings of zero bias with a scale factor of 1.000. What this means is that the logging software should output zero meters when the serial data stream has "0000" in the appropriate analog channel and 128 meters when it has '0128', 5000 meters when '5000' and 9999 meters when '9999' (full scale).

The depth channel does not put out exactly zero volts at zero depth. Nor does a change of one digit '0001' equal one meter. And it varies from unit to unit due to differing sensor full scale values that may have been installed per the customer's system requirements. To correct for this, logging software may allow the user to input a bias (offset) value and a scale factor to transform the incoming device data such that the display readings that correspond to the device's actual reading. DepthCal can be used to avoid having to do the math required to obtain the bias and scale factors as shown in the example below.

**NOTE:** The depth transducer uses a strain gauge mechanism to measure the depth. Strain gauges as a rule are also greatly affected by temperature changes. The depth sensor used in the G-882 has been specially designed to compensate for temperature variations using calibration curves stored in a lookup table which is custom set for each device. None the less it is not perfect. For the best possible depth accuracy the depth bias and scale factors should be set at sea water operating temperatures. A magnetometer on the deck can get very warm from the sun and internal dissipation in contrast to the much cooler ocean even though both are technically at zero depth. The depth sensor is also mounted to a thermally massive aluminum pressure vessel which takes a while to stabilize at the local ambient temperature. Keeping these points in mind please observe the following:

**Submerge the magnetometer before performing any of these procedures and wait 15 minutes for the magnetometer to warm up and allow the sensors to normalize to the water temperature.**

Let's do an example with a typical depth sensor.

1. First in the logging software, set the bias and scale factors to their starting points.
2. Adjust Units to meters (if not in meters already).
3. While logging data, tie off the magnetometer at the surface (zero depth) and write down the value that is reported for depth. You need not be logging to disk. Let's say it reads 112 meters.
4. Lower the sensor down to a known depth (lets say 9 meters). Now, write down the values. You can watch the raw data coming in from the magnetometer. At this point, a one digit LSB change results in a 1 meter change in the depth value reported. Let's say the depth reads 917.0 meters.
5. Now run the Depth Cal program and enter the values written down above for the surface and at some known depth. DepthCal will return Bias and Scale Factors.

6. (In this example we get a Bias = -1.2522 and a Scale = 0.0112). Write these values down for use when setting up your logging software. Restart your logging software and enter the bias and scale factors which were generated by the DepthCal program. Depth should now be working correctly. See example below:

Depth calibration calculator      Version 1.2

Note:

All depth values are assumed to be in meters.

With the sensor at the surface:

What number is displayed for the depth? 112

With the sensor at a known depth:

What depth did you place the sensor at ? 9

What number is displayed for this depth ?

917

Enter a BIAS value of : -1.2522

Enter a SCALE value of : 0.0112

**NOTE:** Some older versions of the DepthCal program instruct you to measure the “Zero Depth” value on the deck of the boat. Instead tie off the G-882 over the side at the surface but still submerged to do this measurement. See the discussion about temperature affects of the depth sensor in the paragraphs above.

### Here is what the DepthCal numbers mean:

We entered a depth change of 9 meters and got a change of 805 meters (917 at depth minus the 112 at surface). To get your logging software to correctly display a change in depth for a given depth change we have to multiply the incoming data by (9/906) which equals 0.0112. This is the scale factor calculated by DepthCal above.

We read 112 meters out of your logging software when the magnetometer was at the surface. Its not really 112 meters though. Using the scale factor correction above we get an actual error of 1.2522 meters ( $0.0112 * 112$ ). Thus to make it read correctly, we have to add a bias of -1.2522 meters which is the bias value calculated by DepthCal.

### Miscellaneous:

Note that once these values are entered, if your logging software remembers them, you will not have to enter them again. Of course, if a different instrument is connected at some later time, new values will be required corresponding to the new instrument.

### Slope – Intercept Method

Here is a method for calculating the Scale Factor and Bias for depth calibration.

At the first depth, let the depth in meters be  $d_1$ , and the raw reading  $r_1$ .

At the second depth, let the depth in meters be  $d_2$ , and the raw reading  $r_2$ .

The formula for the Scale Factor is:

$$(d_1 - d_2) / (r_1 - r_2)$$

The formula for the Bias is:

$$(d_2 \times r_1 - d_1 \times r_2) / (r_1 - r_2)$$

You may also use Excel to calculate these values using linear regression. The advantage here is that you can use more than 2 depths and get a best fit for all the readings.

Put the actual depths in the first column. Put the raw readings in another column:

|   | A                       | B           |
|---|-------------------------|-------------|
| 1 | True Depth              | Raw Reading |
| 2 | 1                       | 30          |
| 3 | 5                       | 34          |
| 4 | 30                      | 46          |
| 5 |                         |             |
| 6 | =INTERCEPT(A2:A4,B2:B4) |             |
| 7 | =SLOPE(A2:A4,B2:B4)     |             |

Use the INTERCEPT function to calculate the Bias. Use the SLOPE function to calculate the Scale Factor. Examples are shown in the table above. For this example, the Slope (Scale Factor) is 1.875, and the Intercept (Bias) is -56.75.

#### 4.5.5 Depth Calibration Using MagLog-Lite™ or MagLog™

MagLog™ logging software from Geometrics provides capability to perform calibration of the depth sensor. It is preformed very much like the methods described above. Refer to the excerpt from the MagLog-Lite™/ MagLog NT™ manual below.

##### **Depth/Analog channel calibration**

In order to get an accurate depth sensor reading, the pressure transducer sensor must be calibrated. This means that the depth sensor reading needs to be compared with a known depth to account for the variations occurring due to air pressure variations and to manufacturing variances. Bias and linearity adjustment can be made in the program to empirically calibrate for depth. (You can read more about this method at the end of the section).

The depth reading from the magnetometer is an integer between 0 and 9999. This represents the full-scale range of the depth transducer. There may also be a certain offset that must be adjusted.

MagLog™ offers a few ways of calibrating the depth.

---

Note: These methods also work for calibrating other analog channels

---

##### **Calibration Procedure:**

The basic procedure for calibrating the depth sensor is as follows:

- 1) Place magnetometer in the water for at least 15 minutes at a known depth, say 3 meters. This will give the temperature of the sensor time to stabilize.
- 2) Write down the depth and reading that MagLog™ gives you.
- 3) Place magnetometer in the water at a DIFFERENT depth.
- 4) Write down the depth and reading that MagLog™ gives you.
- 5) Use either automatic calibration feature or manual calibration to apply results.

*Note: If you use automatic depth/analog channel calibration, you can do this while in the calibration screen.*

## Automatic Depth/Analog Channel Calibration:

- 1) From your configuration screen, you should select the magnetometer. This should bring up the “*Settings*” screen that you originally used to input the number of sensors and analog channels. (You can get to this screen by going into your main list of devices, and then double clicking on the magnetometer description). You should see a screen similar to the one below:

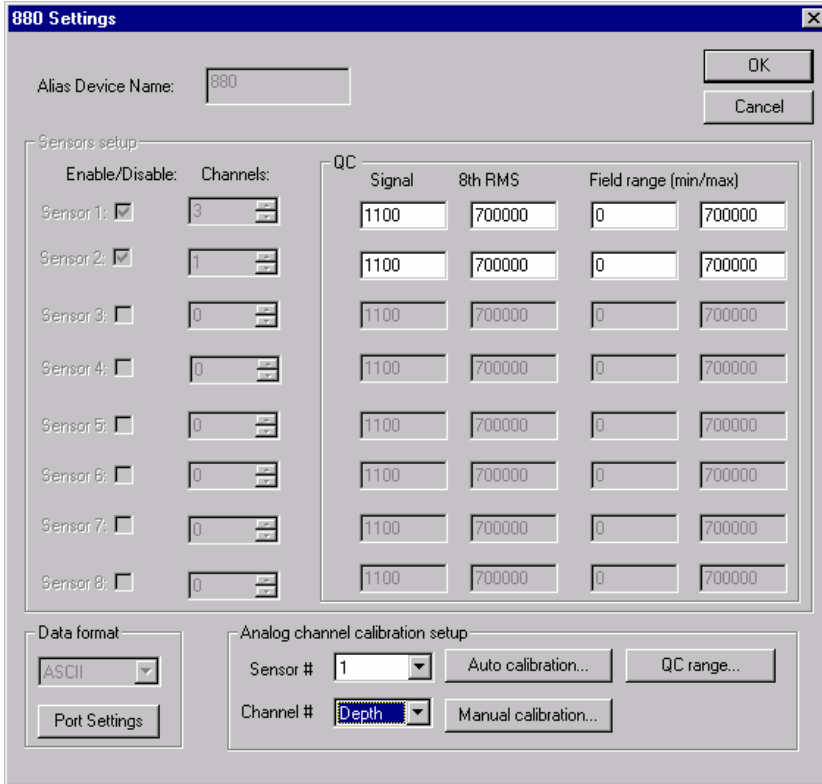

Figure 40

- 2) In the section labeled “*Analog channel calibration setup*” select the sensor and channel number that you want to calibrate, e.g., to calibrate the depth of the first sensor in the earlier example, select  
*Sensor #: 1*  
*Channel #: Depth*

- 3) Select “*Auto calibration*”. You should then see the following dialog box:

Note: At this time depth data is coming from the fish that is being analyzed by the program to compute the bias and scale factor. You must place the fish on at least two depths to get an accurate calculation. During Altimeter Calibration discussed later, you must be over a hard bottom and the fish must be held horizontally level.

You can add measured points to this menu and have it automatically calculate your scale factor and bias. The depth sensor needs to be in the water for at least 15 minutes before you take your first measurement. This allows the temperature of the electronics to stabilize.

To add a new point, place fish at known depth. Press *Reset av.* To discard current average and wait for a few minutes to acquire a new one. Number after text *Current average:* should stabilize. Then enter the depth that the device is at under “*Value*” and press “*Add to the list*”. This will take the average measurement MagLog™ currently sees for the depth, and it will add it to a list of calibration points.

It is important to remember to reset the average if you move the sensor. You can do this by pressing “*Reset Av.*”.

You can also specify an acceptable range of points to be used by pressing “*Acceptable Range*”. This will bring up a dialog box that will allow you to set a minimum and maximum allowed value. This is particularly important when you calibrate your altimeter because occasionally you might get a spiked reading (missed echo) that you don’t want included in the calculation of your average.

After you have at least two points, MagLog™ will then try to calculate a scale factor and bias. You need to make sure that you have at least two different depth points (e.g. it is advised to have one point near the surface, and the second point as close to the bottom as possible). Otherwise, the calibrations

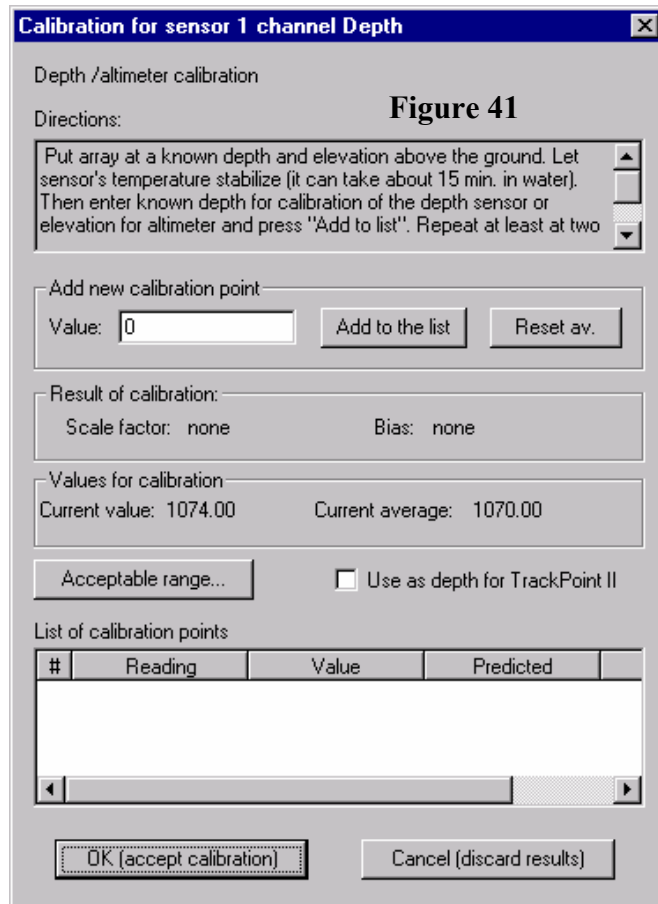

Figure 41

will not be accurate. It is advised to add more than two points to get improved accuracy.

You should also select “*Channel Represents Depth*” from the dialog box in MagLog™. This option is important if you have an ORE Track Point II or other Sonar USBL tracking device and will be using the depth sensor to improve the tracking calculations.

If you are satisfied with the calibration, select “OK”.

- 4) You will then be given the opportunity to save your calibrations into a file. The file will keep track of the scale and bias calculated, and the readings used to make the calculation. It is advised to keep this for your records.

### Manual Calibration

Manual calibration gives you the opportunity to enter the scale and bias directly without having MagLog™ calculate it for you.

You can find the scale and bias by hand, or use third party software.

To use the MagLog™ manual calibration feature, select “*Manual Calibration*” from your device settings menu. (Make sure that you have the correct sensor and channel selected as discussed in the section on “Auto Calibration”.)

You will see a dialog box:

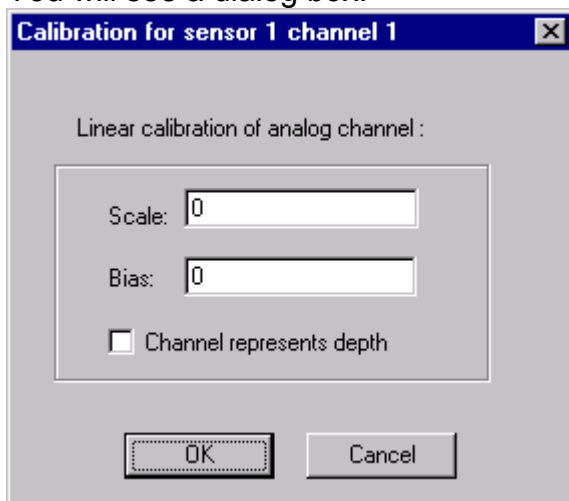

Figure 42

Enter your scale and bias values, and check “*Channel represents depth*” if this is a depth calibration. Then press “OK”.

You will be given the opportunity to save these into a file.



## Effects of Depth Calibration

After you have calibrated your depth sensor, you should see immediate changes in your data. The graphs and displays will use the new calibrated values.

However, the device file will have the uncalibrated values (.880).

If you need to store calibrated values, you should use the Interpolator device that will write calculated depths and altitudes in the interpolator file.

## Why Should We Calibrate?

This is a brief discussion on how MagLog™ calculates scale and bias values and why this is needed.

The depth sensor is a pressure transducer. This means that for a given pressure, it will output a number proportional to the pressure measured. However, the number is meaningless until we solve for a few factors. Assume that the depth reading is related to the pressure reading by the following:

$$\text{Depth} = A \times \text{Pressure} + b$$

In this case, the two parameters A and b are the scale and bias values that we need to find.

We can solve for these two value if we have at least two sets of measurements. If we measure the following:

| Depth | MagLog Reading (pressure) |
|-------|---------------------------|
| Y1    | X1                        |
| Y2    | X2                        |

I can then get two independent equations:

$$Y1 = A \times X1 + b \quad Y2 = A \times X2 + b$$

Solving for A and b, I get:

$$A = (Y1 - Y2) / (X1 - X2) \quad b = (Y2 \times X1 - Y1 \times X2) / (X1 - X2)$$

From here, we can now use these new values to calculate the correct depth, given only the pressure.

MagLog™ can then use these equations to automatically adjust all pressure readings to accurately reflect the depth measured.

## **4.6 Assembly, Installation and Use**

### **4.6.1 Assembly of the Sensor Fish**

As can be seen in Figures 54, the G-882 is assembled and ready for deployment, as shipped. The G-882 may be deployed in a nose towed configuration or a center of gravity (CG) towed configuration. Greater tow depths may be obtained using the CG towed configuration. The following will describe how to configure the G-882 for the desired to method. See section 2.6.2 in the Quick Hardware Guide for instructions on how to configure each of these tow methods.

**DO NOT substitute any other hardware (steel, stainless steel, or anything that you may think is brass) here or anywhere else on the G-882 Magnetometer Fish. Spare hardware is supplied in the Ship Kit. All of the supplied hardware is magnetically tested to insure that it is clean (exhibits no magnetic signature). Failure to follow this caution could introduce heading errors into the data that is acquired making it useless or very difficult to interpret.**

### **4.6.2 Installation of the G-882 Magnetometer**

There are several appropriate tie points that can be used to firmly attach the magnetometer tow cable to the vessel. Remember that the tow cable is rated at 4,000 lb breaking strength (about 700 lbs working load) and while tension during towing at 5 to 7 knots will be a fraction of that with the standard cable length of 200 feet, catching the sensor fish in a net or rock will transfer that force to the attachment point.

a. Attach the Kellems grip to a winch if you are using a substantial amount of tow cable. We recommend a winch if the length of the tow cable exceeds 120 m (400 ft). An on-board deck cable available from Geometrics is used to traverse the distance from the winch installation point to the logging equipment installation site.

b. The tie point may be on the aft deck. Again an onboard cable is required to traverse the distance from the aft deck to the logging equipment installation place.

c. The tie point may be close to where the logging equipment is located. A short adapter cable is provided to connect the tow cable to the DC/Data Junction Box. An RS-232 cable will then run from the junction box to the

logging computer. A 6 foot cable is supplied but an RS-232 extension cable of up to 40 or 50 feet could be used.

While reading this section, refer to the System Connection Diagram in Appendix B.

The Junction Box functions as the connection point for power and signals required for a functioning G-882 magnetometer system. The Data Logging computer, Junction Box and the power source should be installed in a protected environment. These items are susceptible to water damage and most likely will cease to function if they become wet, particularly with salt water from a sea wave. Their installation could be in the cabin of the boat or the equipment room if there is one. In a very small boat, provide some protection by elevating this equipment from the deck and covering it with a tarp or provide a waterproof enclosure.

#### 4.6.3 Deployment of the G-882 Magnetometer

Turn the power on the DC/Data Junction Box and the Logging Computer. After five minutes warm up for the magnetometer and boot up of the Logging Computer, start the logging software as described in the Quick Start Software Guide or the MagLog™ manual. If you have not previously used the Survey Wizard to set up a survey, do so now. If you have previously created a survey, use the “Start New Survey” from the File menu and then select “Same Hardware as Last Survey” to set the configuration.

If the magnetometer is positioned horizontally on the deck away from any steel objects, you may begin to see readings that represent the intensity of the earth’s field in the survey area. If you are on a steel hulled vessel, you may not see quiet data until you launch the magnetometer fish and it is about 30m (100ft) behind the vessel. With the system running you can proceed to perform the calibration of the depth sensor as described in Section 4.5.4 of this manual.

If the logging software is operating at power-on time, the following outlines what might be observed as the magnetometer is powered-on and warms up to operating temperature. **If the numbers observed are somewhat outside the ranges given below, the magnetometer is still in most situations, operating properly.** Extreme temperature conditions may cause some of these values to go significantly outside these ranges during normal operation.

1. Just after power-on and before the counter begins normal operation some erroneous data may be observed for a brief period of time.
2. When the counter begins normal operation the following may be observed as the magnetometer begins to warm up:

- A. The magnetometer reading will be erratic as the sensor begins to warm up.
- B. Analog channel 0, the signal level, will be around 0010 and will increase during warm-up.
- C. Analog channel 1, the depth sensor, will exhibit a value near 0100 (unscaled) with the G-882 in air, out of the water. If no depth sensor is installed in the G-882, the value could vary between 0000 and 0050.
- D. Analog channel 2, the altimeter, will exhibit a value near 9900 (unscaled) with the G-882 in air, out of the water. If no altimeter is installed in the G-882, the value could vary between 0000 and 0050.

If the additional diagnostic analog channels are enabled, the following may be observed:

- E. Analog channel 3, the brightness, will exhibit numbers beginning about 3400, jump to 4300 after a minute or two and then slowly rise towards a number around 5600 as the magnetometer warms up.
- F. Analog channel 4, the RF, will exhibit numbers beginning low, fairly quickly ramping up to some high numbers and as the magnetometer warms up slowly settling down to a number around 2100.
- G. Analog channel 5, the heater, will exhibit numbers beginning low, very quickly ramping up to some numbers as high as 3400 (this final value will be determined in part by the ambient temperature) and then settling down to a number around 1600.
- H. Analog channel 6, if not used, could vary between 0000 and 0050. As shipped, jumpered to an internal voltage, 28V, analog channel 6 could immediately exhibit numbers between 5005 and 7890. If used for an external input (this capability not currently implemented in the G-882), the values will depend upon the characteristics of the user device attached.
- I. Analog channel 7, if not used, could vary between 0000 and 0050. As shipped, jumpered to an internal voltage, 21V, analog channel 7 could immediately exhibit numbers between 4600 and 5300. If used for an external input (this capability not currently implemented in the G-882), the values will depend upon the characteristics of the user device attached.

- 3. When the magnetometer is warmed up the following may be observed:
  - A. If the magnetometer is properly oriented to the ambient field and not near any large metal objects, a reading indicating the magnitude of the ambient field will be observed.
  - B. Analog channel 0, the signal level, depending on the field magnitude and sensor orientation, a normal signal could vary between 0900 and 1200.

- C. Analog channel 1, the depth sensor, will exhibit a value near 0100 (unscaled) with the G-882 in air out of the water. If no depth sensor is installed in the G-882, the value could vary between 0000 and 0050. If the G-882 is in the water the value should vary with and be indicative of depth.
- D. Analog channel 2, the altimeter, will exhibit a value near 9900 (unscaled) with the G-882 in air, out of the water. If no altimeter is installed in the G-882, the value could vary between 0000 and 0050.

If the additional diagnostic analog channels are enabled the following may be observed:

- E. Analog channel 3, the brightness, will exhibit a value around 5600, but may vary between 5350 and 5850.
- F. Analog channel 4, the RF, will exhibit a value around 2100, but vary between 2000 and 2400.
- G. Analog channel 5, the heater, will exhibit value around 1740, but vary between 1700 and 1900 depending upon ambient temperature.
- H. Analog channel 6, if not used, could vary between 0000 and 0050. As shipped, jumpered to an internal voltage, 28V, analog channel 6 could exhibit a value around 6500, but vary between 5005 and 7090. If used for an external input (this capability not currently implemented in the G-882), the values will depend upon the characteristics of the user device attached.
- I. Analog channel 7, if not used, could vary between 0000 and 0050. As shipped, jumpered to an internal voltage, 21V, analog channel 7 could exhibit a value around 5100, but vary between 4600 and 5300. If used for an external input (this capability not currently implemented in the G-882), the values will depend upon the characteristics of the user device attached.

In either configuration above, nose or CG tow, the magnetometer can be lifted over the side by one person. However, the deployment will be much easier and smoother with two or more people handling the operation. Due to much lower levels of drag force, the nose towed magnetometer may be handled by one strong person. Cowhide work gloves provide the best protection and grip for handling the wet tow cable.

There are two methods to handle the cable on deck if a winch is not used:

1. Neatly fake (figure eight) the cable down on the deck beginning with the onboard end. As this is done remove any twists in the tow cable. The cable may be deployed from the figure eight without knots and kinks. One person should be assigned to tend the cable on and off of the figure eight. This method is better for cable up to 120m (400ft).

2. Neatly lay the cable out in long loops bow to stern on the deck beginning with the onboard end. As this is done remove any twists in the tow cable. The cable may be deployed from the loops on the deck without knots and kinks. One person should be assigned to walk the loops back on the deck during retrieval. This method works well with cables up to 60m (200 ft).

Tow cables longer than 90m to 120m (300ft to 400ft) should probably be handled with a winch.

Manual deployment, is best handled with two people, especially when additional depressive weights are being used, a third person should manage the tow cable. The vessel should be making 1 to 1 ½ knots during deployment. It may be necessary to increase the vessel speed as more cable is deployed to prevent the magnetometer from striking the bottom. The more quickly the desired cable length can be deployed and the desired tow speed attained reduces the chances of the magnetometer going too deep striking the bottom or becoming hung. The recommended cable management mentioned above will aid in quick deployment. Another method is to stop playing out tow cable a few times during deployment while under tow. This will allow the tow fish to rise towards the surface. If a CG towed fish with a depressor wing is being deployed, it pulls with significant force. It may require two or three people to hold it during the play-out stops.

It is best if the tow cable is tied to the vessel before the vessel begins to acquire the desired tow speed. The magnetometer with the depressor wing produces strong pull forces under tow speed of 4 to 6 knots.

Determine the approximate length of tow cable to be deployed to achieve the required survey depth. We recommend that the Kellems grip provided on the tow cable be used to secure the tow cable to the towing vessel. Slide the Kellems grip to set the length of tow cable desired to be deployed plus some additional cable to account for the distance from the ship to the cable water entry point. Secure the Kellems to the tow cable as shown in Figure 43. **DO NOT** tape along the whole length of the Kellems; this will prevent it from working properly. Attach the Kellems to the towing vessel using a strong line tied to the loop of the Kellems grip.

A Kellems grip is like a child's toy finger trap. The stronger the forces that pull on it, the tighter it grips the cable. If the Kellems grip needs to be moved to adjust the amount of tow cable deployed, remove the tape anchoring it to the tow cable and compress each end to the Kellems towards the other along tow cable. This will expand the Kellems and allow it to slide easily along the cable to its new position. Release the ends of the Kellems, re-anchor the end towards the towfish as shown Figure 43 and then smooth it back down along the cable towards the vessel.

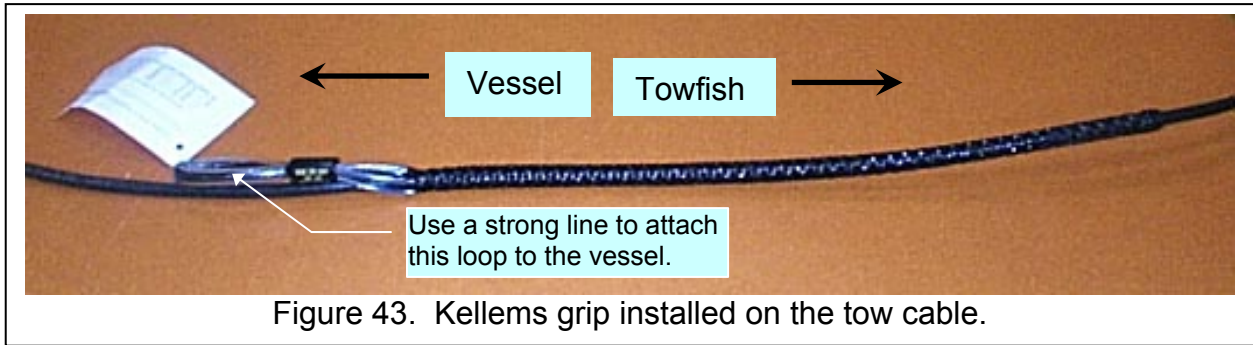

Retrieval is best performed with the vessel at full stop (propeller not turning) or maintaining just enough headway to keep the cable from going under the vessel. The intent is to prevent the tow cable from becoming entangled in the propellers. Nothing destroys surveys and propeller shafts quicker than entangling the tow cable in the propellers.

Retrieve the cable as quickly as possible to help prevent the magnetometer from striking the bottom. Again, neat tow cable management as described above will greatly facilitate survey execution.

It is recommended that some form of quick communications be provided between the vessel captain and the magnetometer handlers. This will greatly ease handling and make the operation safer. Radios work well.

The tow cable length is generally determined by a number of factors. The most important factor is the desired depth of tow that must be achieved for the survey. The longer the cable, the greater the depth that can be achieved. The depth of tow may also be improved by the type of towing method selected for the magnetometer tow fish.

For shallow surveys on short tow cables (30 to 60 meters), the Nose Tow method works the best. One man can manage deployment and retrieval with a second man to manage the tow cable. The depth of tow graph below for a nose towed G-882 is derived from actual tests. However, it **DOES NOT** provide exact numbers. It is just intended to provide an indication of the tow depths that might be expected. The actual depth of tow can be affected by water current speed and turbulence. Also, turns to change course greatly slow the speed of tow increasing the tow depth. If you know you are towing in an area that may have potential snags upon which the tow fish may hang, retrieval of tow cable in the turns may be required to manage the tow fish depth guarding against snagging. This graph is provided as a suggestion of what tow depths might be expected using a nose towed G-882 magnetometer.

G-881 Nose Tow Depth vs Speed on a 175 ft Cable Length

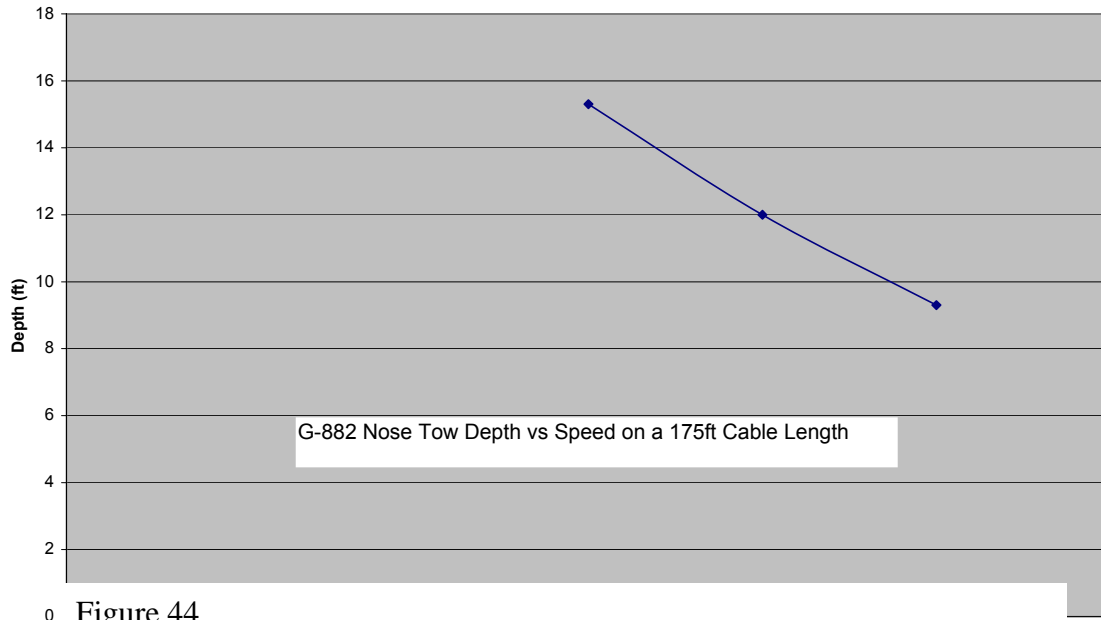

Figure 44

6

Towing a magnetometer fish from its center of gravity provides a method to allow the fish to be towed deeper, hence closer to the bottom for a better detection range. Generally, a CG towed G-882 will tow two to three times deeper than when nose towed. Adding a depressor wing to the CG tow point may double the depth again. Geometrics offer both options for the G-882. The following provide information regarding tow depths that may be expected and instructions for assembling.

The following graphs provide an approximate indication for tow depths that may be expected versus the cable length deployed versus the speed of tow. These graphs are derived from actual tests. However, they **DO NOT** provide exact numbers. The actual depth of tow can be affected by water current speed and turbulence. Also, turns greatly slow the speed of tow increasing the tow depth. If you know you are towing in an area that may have potential snags upon which the tow fish may hang, retrieval of tow cable in the turns may be required to manage the tow fish depth guarding against snagging.



### G-881 CG Tow Cable Length vs Depth

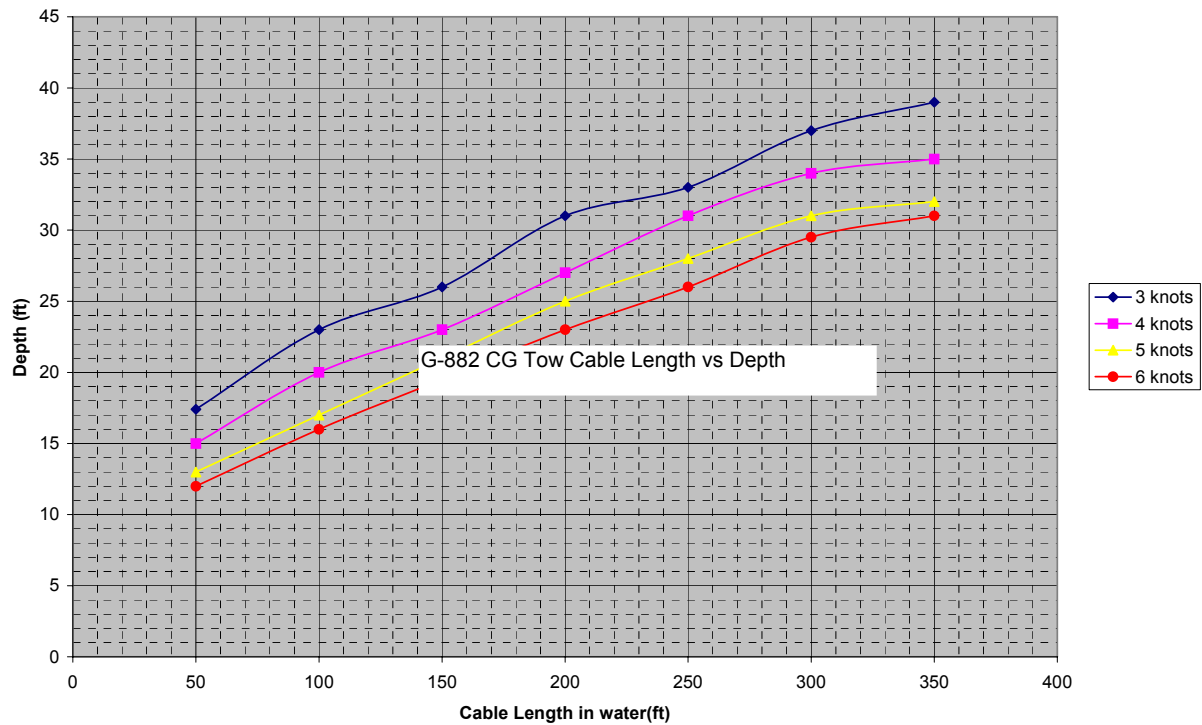

Figure 45

## 5.0 Service Information and Trouble Shooting Guide

It is possible to open the G-882 in the field, but is not recommended. There are no easily assessable parts that can be field serviced. It is recommended that if service is required, the G-882 be returned to the factory for service.

### 5.1 Connector Information

The following Figures provide views of the connectors used on the G-882 tow cable.

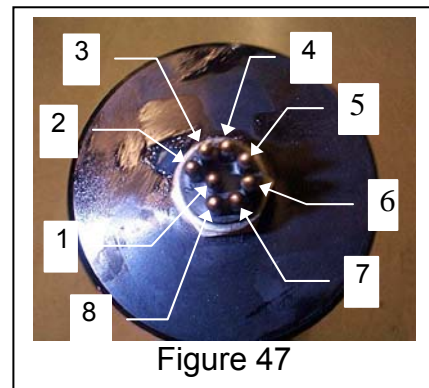

Figures 59 and 60 show the male water tight connector on the nose bulkhead of the G-882 magnetometer. Figure 60 also shows the pin numbers for this connector. The Geometrics part number for this connector is 21-236-400.

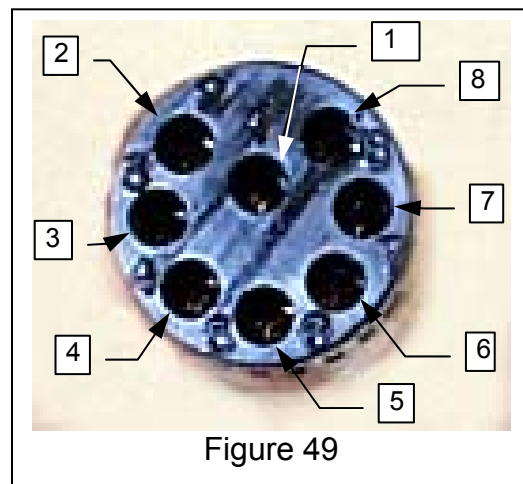
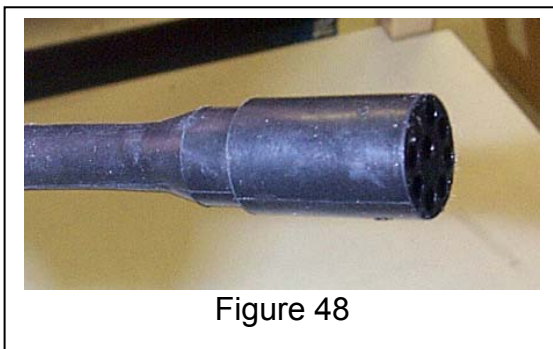

Figures 48 and 49 show the female water tight connector on the wet end of the tow cable. This connector mates with the connector of Figures 50 and 51. Figure 49 also shows the pin numbers for this connector. The Geometrics part number for this connector is 21-236-410.

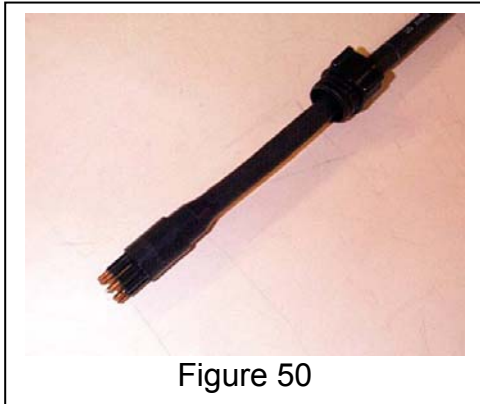

Figure 50

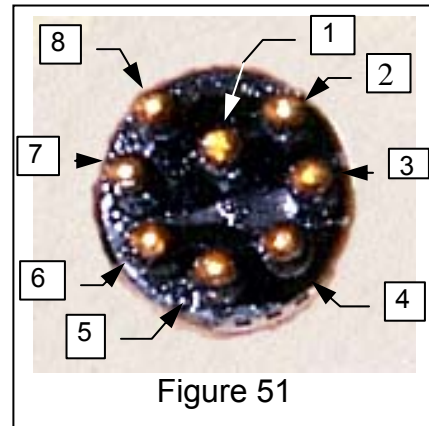

Figure 51

Figures 50 and 51 show the male water tight connector on the dry end of the tow cable. This connector mates either to the adapter cable shown below or to a winch if one is used. Figure 51 also shows the pin numbers for this connector. The Geometrics part number for this connector is 21-236-411.

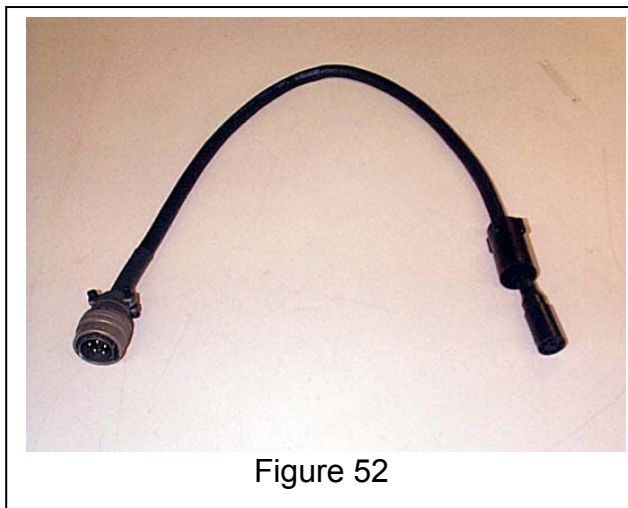

Figure 52

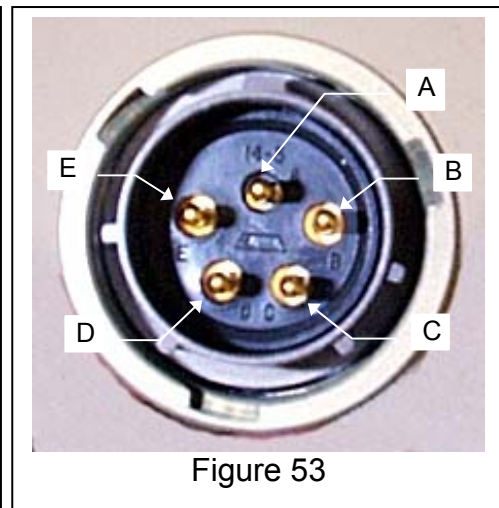
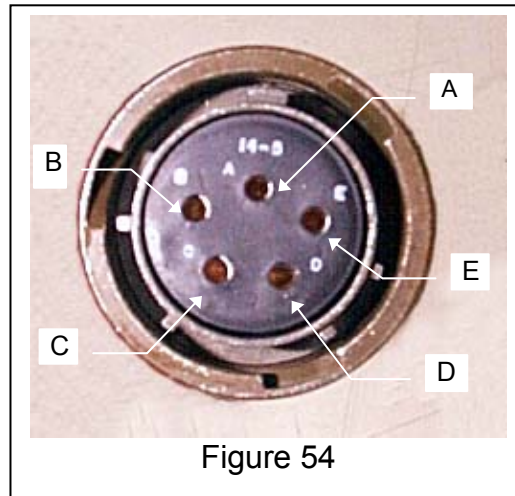

Figure 53

If the tow cable purchased with your system is terminated as shown in above in Figure 50, an adapter cable as shown in Figure 52 is provided to allow connection the DC/Data Junction Box. The connector on the left in Figure 52 is a Bendix connector. It mates with the connector labeled ONBOARD on the DC/Data Junction Box. Figure 53 shows the pin numbers for the Bendix connector.

The connector that should be connected to the tow cable is the same as the wet end of the tow cable shown in Figures 48 and 49. This end should be mated with the dry end of the tow cable. Prepare these connectors for installation by insuring that the connectors on the tow cable and the adapter cable are clean and free of dirt. Using a finger, wipe a small amount of silicon grease across the face of the connector of the adapter cable. If this is done properly, there will be a “half moon” of grease visible in each of the pin sockets of this connector. The correct silicon grease is provided in a small circular, snap-lid container in the ship kit. Unless it is cleaned, once greased this connector may never require grease again.



The connector shown in Figure 54 is the DC power connector on the AC/DC power supply. The connector in Figure 54 is a Bendix connector. It mates with the connector labeled 22-32 VDC on the DC/Data Junction Box. Figure 54 shows the pin numbers for the Bendix connector.

## 5.2 O-ring Maintenance

The O-rings **do not** require maintenance. Unless the a bulkhead is removed from the magnetometer fish, the O-rings do not require maintenance. Geometrics does not recommend the customer open the magnetometer fish under any circumstances. There are no customer maintainable parts within.

Should the customer inadvertently remove a bulkhead or do so under instructions from Geometrics, the following procedure should be observed to re-install the bulkhead.

Remove the two O-rings from their grooves on the bulkhead. Using a clean towel, clean any contaminants that may be observed on the barrel of the bulkhead or in the O-ring grooves. Inspect the inside of the magnetometer fish from where the bulkhead was removed. Clean any contaminants that may be observed.

Take the two replacement O-rings provided in the ship kit and apply some silicon grease provided in a small circular, snap-lid container in the ship kit. Take a little grease between your thumb and index finger. Gently pull the circumference of the O-ring between your greased fingers to thoroughly apply a complete layer of grease to the O-ring. Gently stretch the O-ring over the small end of the bulkhead and slide it into one of the O-ring grooves. Repeat this process with the second O-ring and place it in the other O-ring groove of the bulkhead. Take a little more grease on your index finger and wipe it on the circumference of the O-rings on the bulkhead.

Install the bulkhead into the magnetometer fish. Push the bulkhead straight in to insure proper installation.

### 5.3 Depth Sensor Ratings

There are four choices for a Depth Sensor that may be installed in a G-882.

They are: none

100psi

250psi

500psi

These depth(pressure) sensor(s) will operate to 200% (for a 100psi sensor this would be 200psi) over pressure without damage or the calibration change. Exceeding 200% may cause a permanent change in the calibration as the sensor is permanently deformed. Sensor failure to produce data may occur if 200% over pressure is exceeded.

These depth sensors are safe from bursting up to 400% over pressure with out bursting. The pressure sensor will be useless after this over pressure but it should not burst protecting the magnetometer from flooding. The pressure sensor will not burst at exactly 400% over pressure and may survive higher pressure without bursting. **However, if pressure is approaching 400%, every effort should be immediately undertaken to prevent the G-882 from going deeper to prevent bursting of the depth sensor.**

### 5.4 Tow Cable Strength Data

Recent design changes have made a stronger tow cable available. Data for both the "original" and the "new" cable are provided for those who may have the original cable with a magnetometer previously purchased from Geometrics.

#### Original Tow Cable

Color: black

Marking: GEOMETRICS, INC., P/N 60-453-095

Breaking Strength: 4000 lbs.

Maximum Working Load: 800 lbs.  
Minimum Bend radius: 4.5 in.

### **New Tow Cable**

Color: Green  
Marking: GEOMETRICS, INC., P/N 60-453-101  
Breaking Strength: 4000 lbs.  
Maximum Working Load: 800 lbs.  
Minimum Bend Radius: 9 in.

The working loads exerted on the tow cable by the G-882 vary depending on the type of towing method used. The lowest amount of force exerted is the G-882 nose tow configuration. Next is the CG towed configuration. Care should be taken to minimize the working load exerted on the tow cable. Exceeding the maximum working load, will, over time, cause the tow cable to fail electrically. The conductors may become work hardened and break. Following are some suggestions to minimize the work load:

1. Keep the tow speed to a maximum of six knots.
2. Slow the vessel down to 1-2 knots to retrieve tow cable.
3. Slow the tow speed in high seas to reduce the effect of heave on the tow cable, or cease the survey.

Should the tow fish become snagged, the much higher breaking strength may help insure that the tow fish is successfully retrieved. However, this will exert loads on the cable well in excess of the working load. Before the cable is used again it should be carefully inspected and tested. It may still be usable, but its life will have been shortened. How much, depends upon how close to the breaking strength the force induced by the snag was.

## **5.5 Trouble Shooting Guide**

Always record Serial Number, Signal Level, Sensor Orientation, and Latitude/Longitude before contacting Geometrics.

1. Power check (Use MagLog Diagnostic Survey or multiply channel 7 by 0.004805 then subtract 2.048 to scale to Volts DC)
  - a. Minimum 24 Volts DC at electronics bottle
  - b. Maximum 33 Volts DC at electronics bottle
  - c. Starting current 1 Ampere at 28 Volts
  - d. Running current 0.3 to 0.6 Ampere at 28 Volts depending upon ambient temperature
2. Connector checks

- a. Dirt or corrosion
  - b. Bent pins
  - c. Backshell tight
3. Cable jacket check
  - a. Kinks
  - b. Abrasions
  - c. Cuts
4. Sensor orientation
  - a. Use MagPick IGRF and CSAZ to model sensor behavior
  - b. Adjust sensor orientation and observe dead zones
  - c. Return sensor to correct orientation for the survey area
5. Field readings
  - a. Reasonably close to MagPick IGRF model estimate
  - b. Sample to sample noise less than 0.1 nT when not moving.
6. Field Larmor amplitude check – Signal should be at least 800 when correctly oriented. Maximum signal should be less than 2000.
7. Larmor amplitude check and adjustment (Authorized Repair Facility only)
  - a. Pot on GSN to adjust for 1.5 to 2.0 Volts Peak to Peak at 50,000 nT after 20 minute warm up.
8. Heater check and adjustment (Authorized Repair Facility only)
  - a. 34.5 K ohms after warm up

| Symptom                       | Probable Causes  | Corrective Actions  |
|-------------------------------|--|---|
| Long warm-up time             | <p>Low voltage</p> <p>Faulty sensor cable connection</p> <p>Heater setting too cool</p> <p>Excessive cold</p> <p>Defective internal sensor or electronics components</p> | <p>Increase voltage (minimum 24 VDC at the electronics) or repair the Coax cable</p> <p>Connect the fish directly to the deck cable or cable adapter</p> <p><i>Disconnect sensor from electronics and carefully clean the pins and sockets*</i></p> <p>Adjust heater to 34.5 Kohms*</p> <p>Normal – allow extra time for sensor to warm up in extremely cold environments</p> <p>Return fish to Geometrics for repair</p> |
| Noisy magnetic field readings | <p>Sensor not oriented correctly</p> <p>Magnetically “Noisy” location</p> <p>Signal amplitude too low</p> <p>Sensor cable or connector worn or damaged</p>               | <p>Use MagPick IGRF and CsAz software to model magnetic field and sensor behavior, then determine a correct orientation</p> <p>Move to a magnetically clean area</p> <p>See next section on low signal causes</p> <p>Replace sensor cable and connector assembly. Check connector on electronics module for wear and replace if required*</p>   |
| Low Signal Level              | Sensor not oriented correctly  | Use Magpick IGRF and CSAZ software to model   |



| Symptom                          | Probable Causes  | Corrective Actions  |
|----------------------------------|--|---|
|                                  | <p>High magnetic gradient</p> <p>Low power supply voltage</p> <p>Heater setting incorrect (too hot or too cold)</p> <p>Insufficient warm up time</p> <p>Signal adjustment is set wrong</p> | <p>magnetic field and sensor behavior, then determine correct orientation.</p> <p>Check gradient by moving sensor back and forth East/West, North/South, and Up/Down while noting changes in the magnetic field. Signal level diminishes rapidly when the magnetic field is changing by more than 200 nT per foot. Move the sensor to a less magnetically cluttered area if the gradient is more than 200 nT per foot.</p> <p>Increase power supply voltage (minimum of 24 VDC at the electronics).</p> <p>Adjust heater such that the temperature sensing thermistor stabilizes at 34.5K ohms*</p> <p>Allow 20 minutes for the magnetometer to warm up and stabilize (longer in extreme cold).</p> <p>Adjust signal level*</p> |
|                                  |  |   |
| Sensor connector damaged or worn | Handling, mechanical problem, accident, or normal wear.  | Correct handling or mechanical problem. Then replace sensor cable and connector*  |
|                                  |  |   |
| Excessive current consumption.   | Defective sensor or electronics  | Return fish to Geometrics for repair.   |
|                                  |  | *Authorized repair shop only  |

## 5.6 The Diagnostic Survey – How to use it

Geometrics is now distributing a Diagnostic Survey as part of the MagLog software that can be downloaded from the Geometrics ftp site:

<ftp://geom.geometrics.com/pub/mag/Software>

Choose the file, [MagLog\\_latest.exe](#) to download and install MagLog with the Diagnostic Survey. The Diagnostic Survey will be installed in the same directory as MagLog, usually:

[C:\Program Files\Geometrics](#)

You can now Start a new survey and use the Diagnostic Survey as a template.

Normal values for the various slots are:

mag – A trace indicating magnetic field variations

signal – Between 600 and 1500 after 15 minutes of operation with the sensor properly oriented

depth – Between 100 and 9900

alt – Between 100 and 9900

Bright – Between 5332 and 5893 after 15 minutes of operation

RF – Less than 2500 after 15 minutes of operation

Heat – Approximately 1600 at room temperature. Maximum is about 3400 and minimum is about 0800

+28V – Between 24.0 and 33.0

+21Va – Between 20.0 and 23.5

Start by choosing Start New Survey from the File menu.

Next choose a location for your survey.

You can choose to make a new folder by clicking on the icon with an asterisk, then naming the folder as shown below.

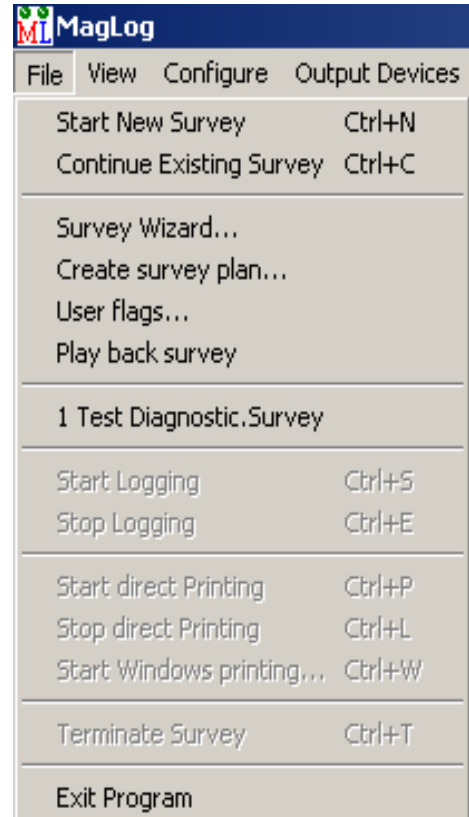

Figure 55

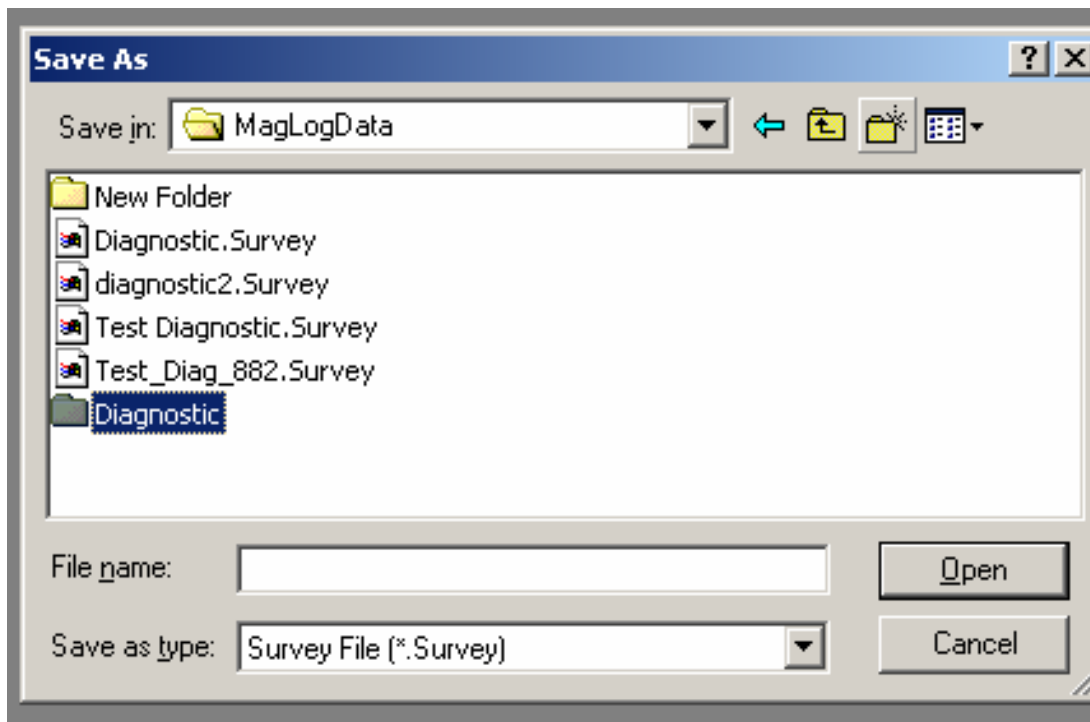

Figure 56

Press the Enter Key after naming the new folder until the Save As dialog box shows no files or folders.

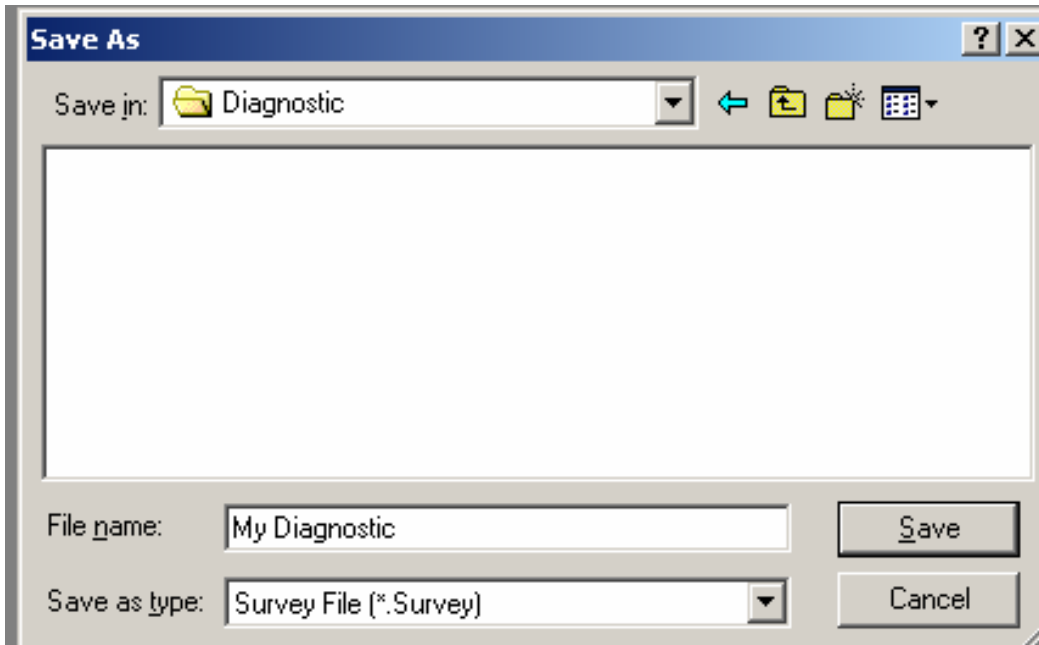

Figure 57

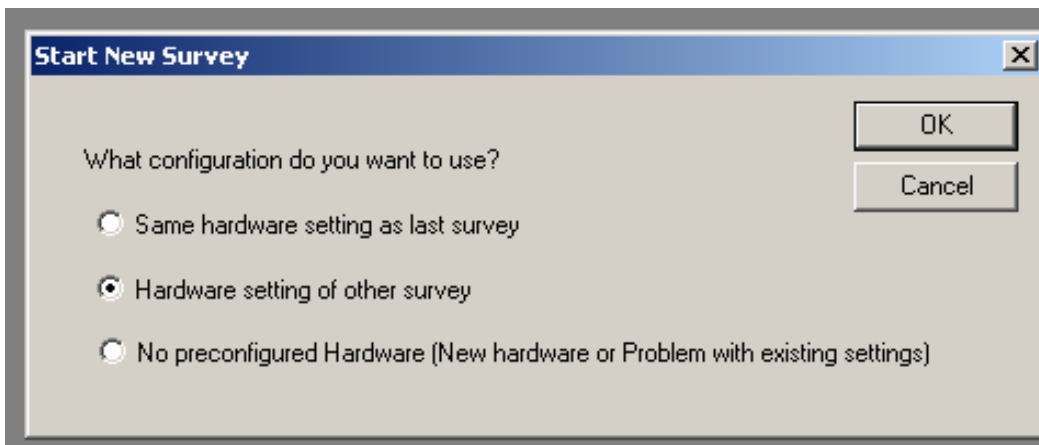

Figure 58

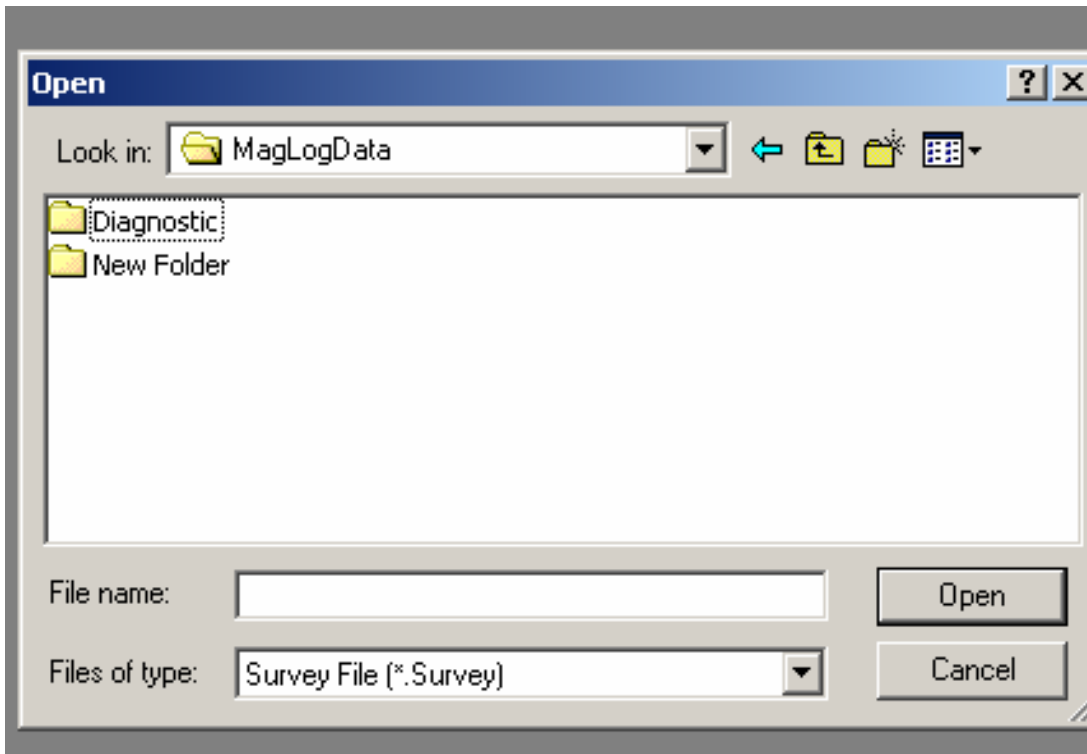

Figure 59

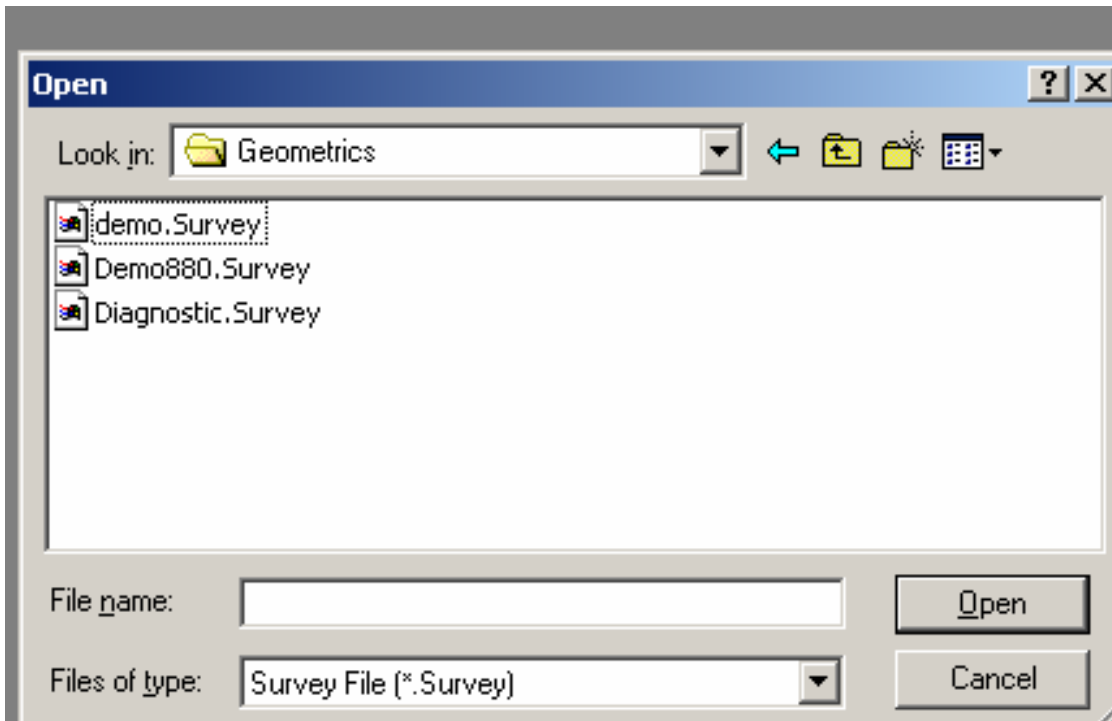

Figure 60

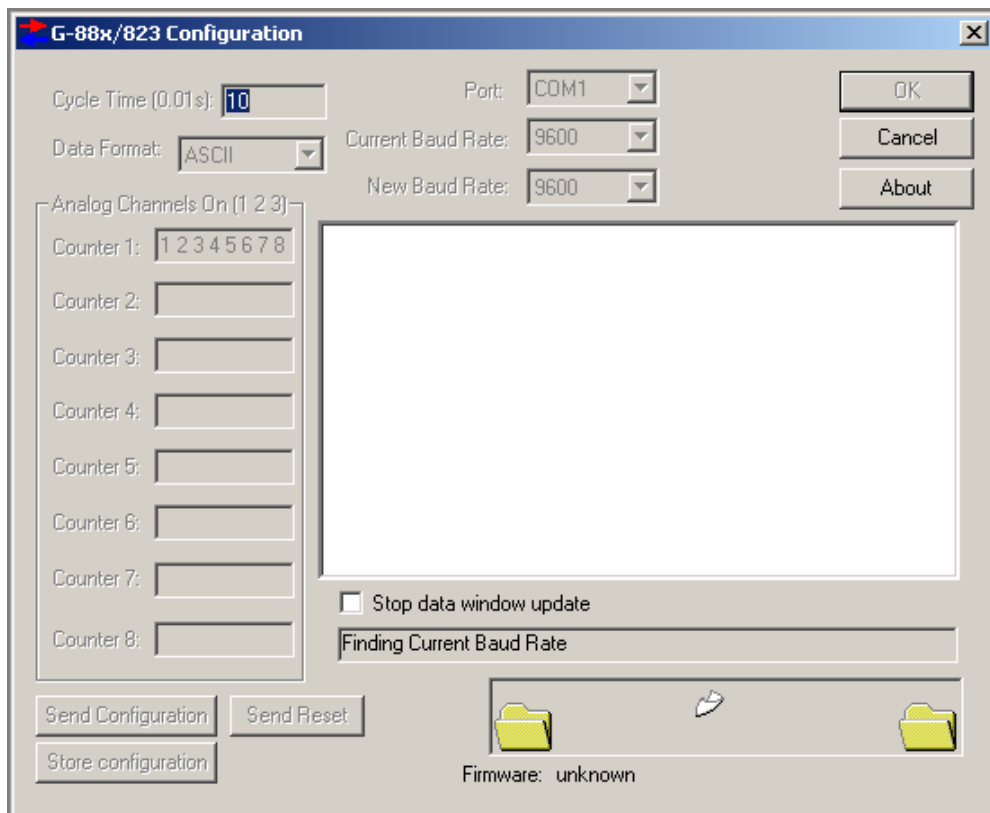

Figure 61

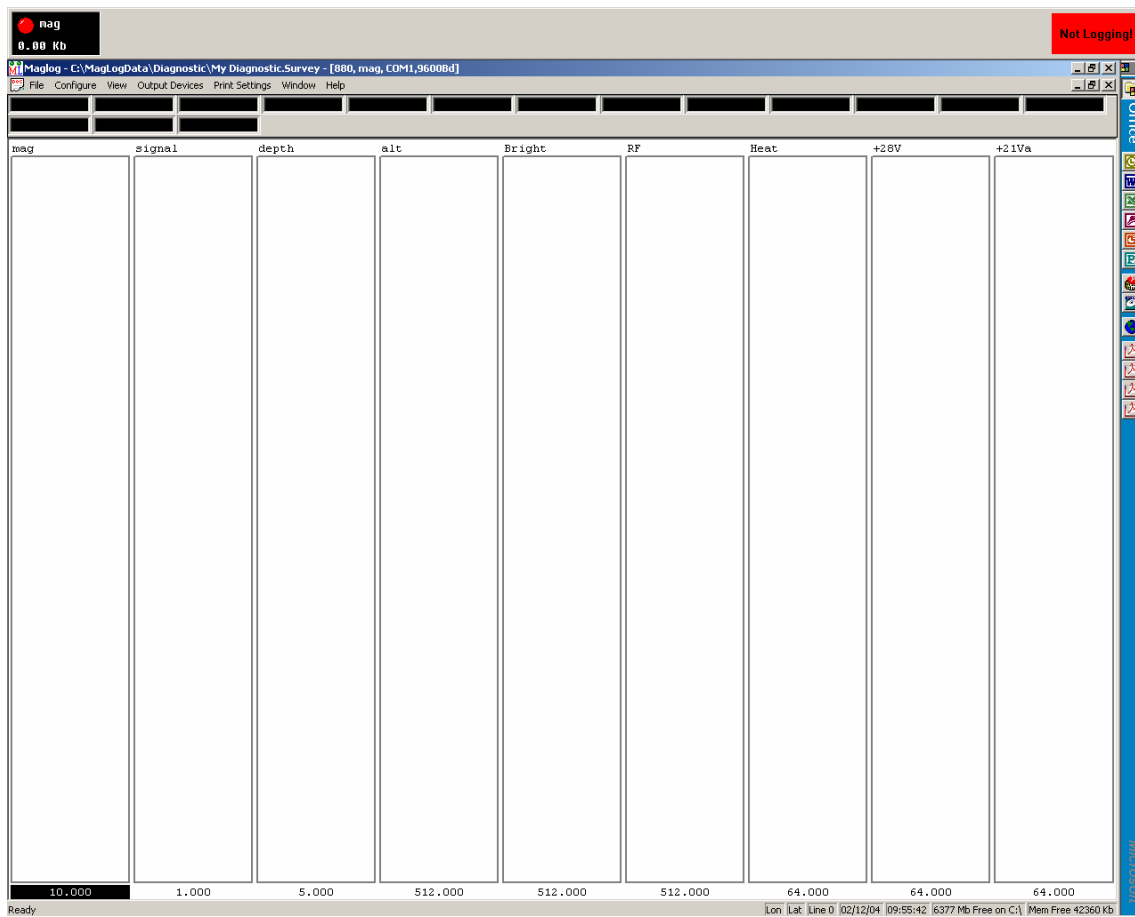

Figure 62

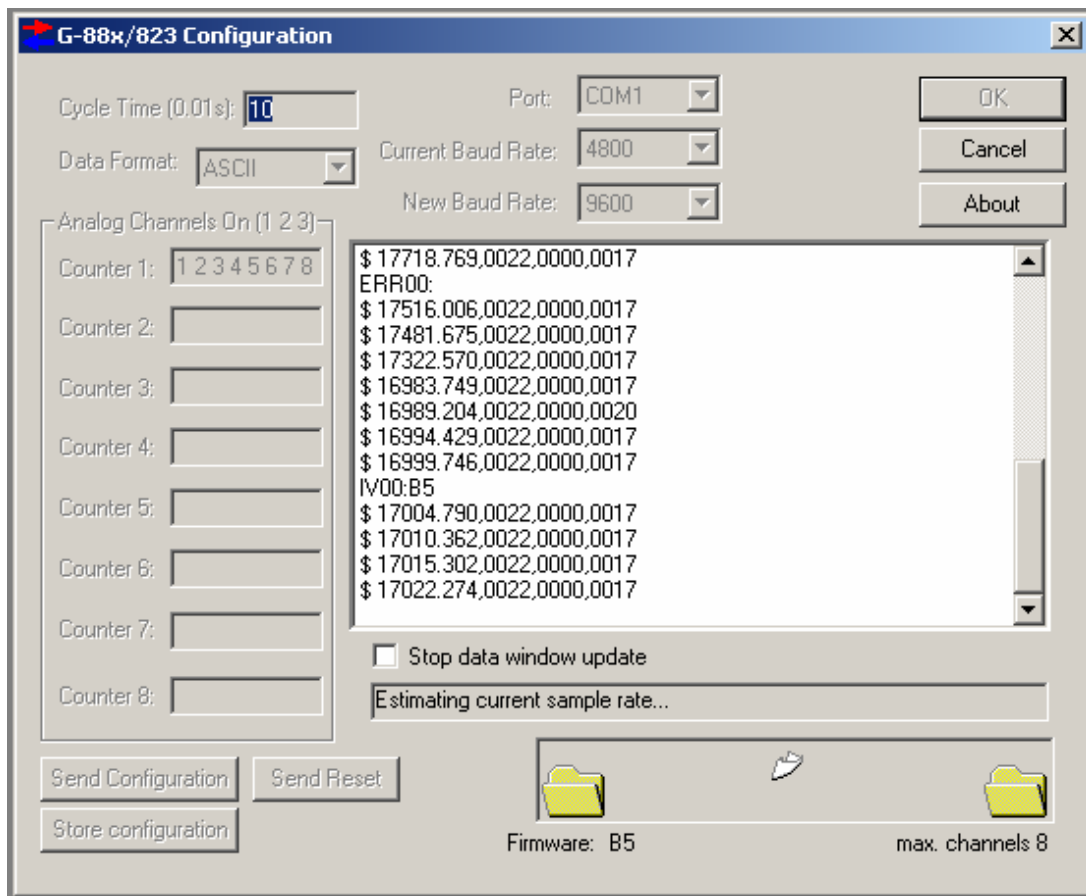

Figure 63



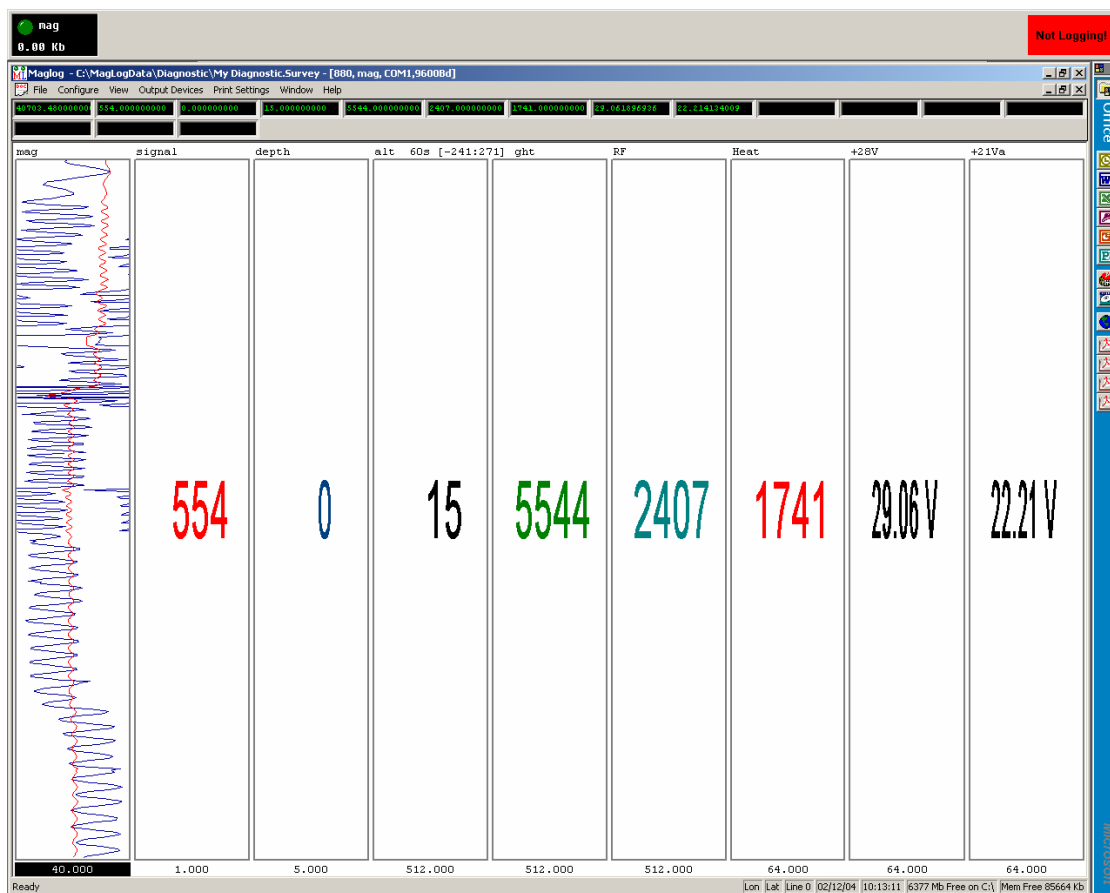

Figure 64

Final MagLog screen will look as above to provide diagnostics for system troubleshooting.

## 5.7 Voltage Calibration for Magnetometers using CM-221 Counters

You can apply the following Scale and Bias to Channel 7 to calibrate the +28 Volt measurement available in these models:

Scale 0.004805

Bias -2.048

You can apply the following Scale and Bias to Channel 8 to calibrate the +21 Volt measurement available in these models:

Scale 0.004805

Bias -2.048

Please refer to the following pages to see examples of the screens displayed during this calibration.

# MagLog Screens

Figure 65

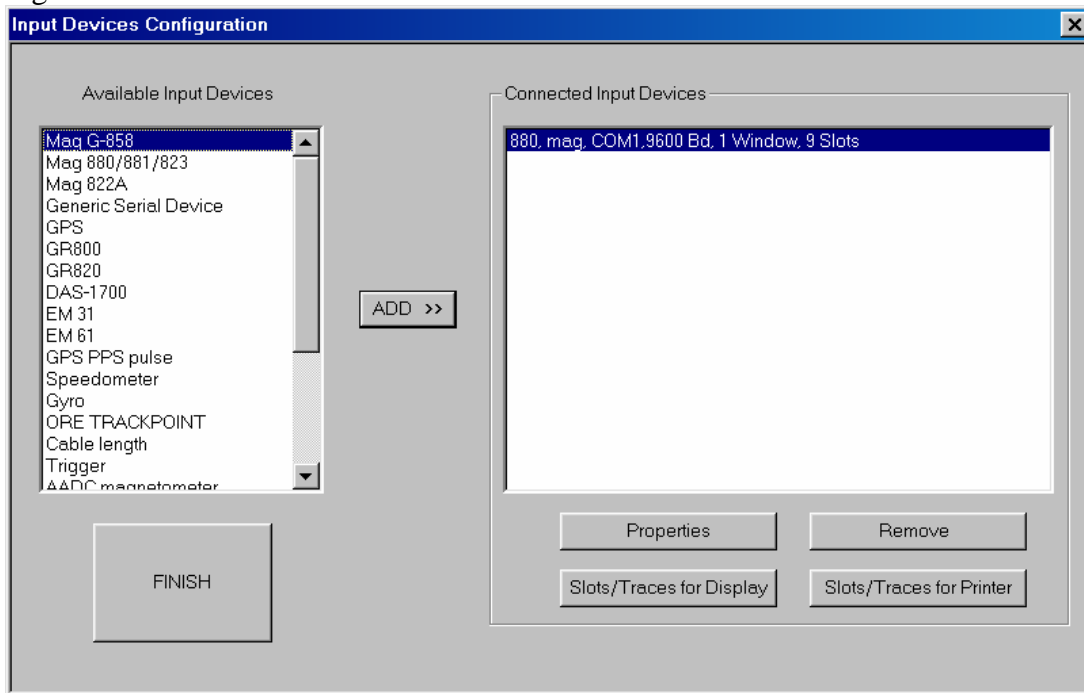

Click the Configure menu item and choose Input Devices. Then highlight the magnetometer device and click Properties.

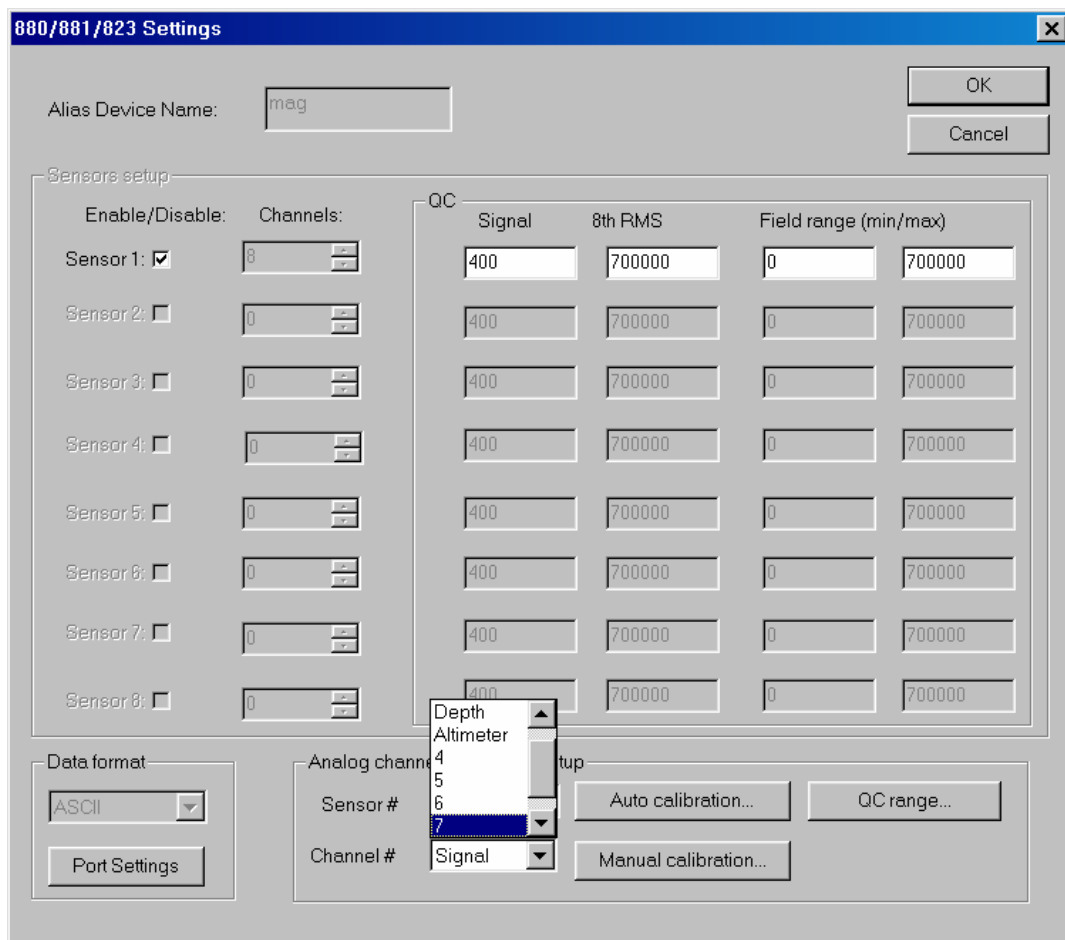

Figure 66

Click Channel number and choose 7 to apply calibration coefficients for +28 Volts or choose 8 to apply calibration coefficients for +21 Volts.

Then click on the Manual calibration... button to enter Scale and Bias.

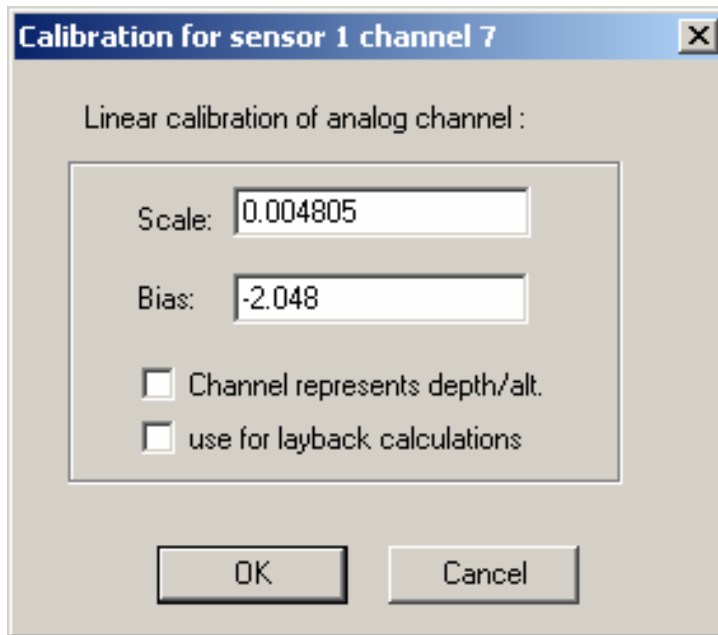

Figure 67  
Scale and Bias for +28 Volts are shown above.

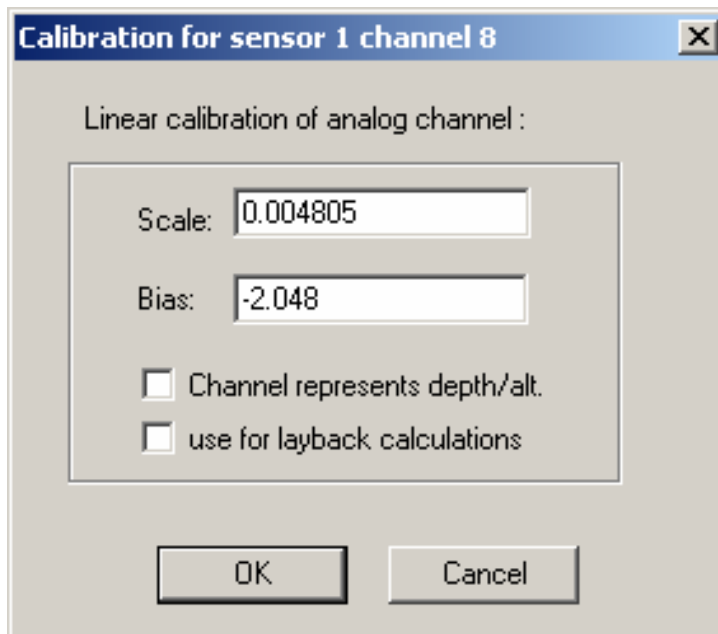

Figure 68  
Scale and Bias for +21 Volts are shown above.

## MagMap Screens

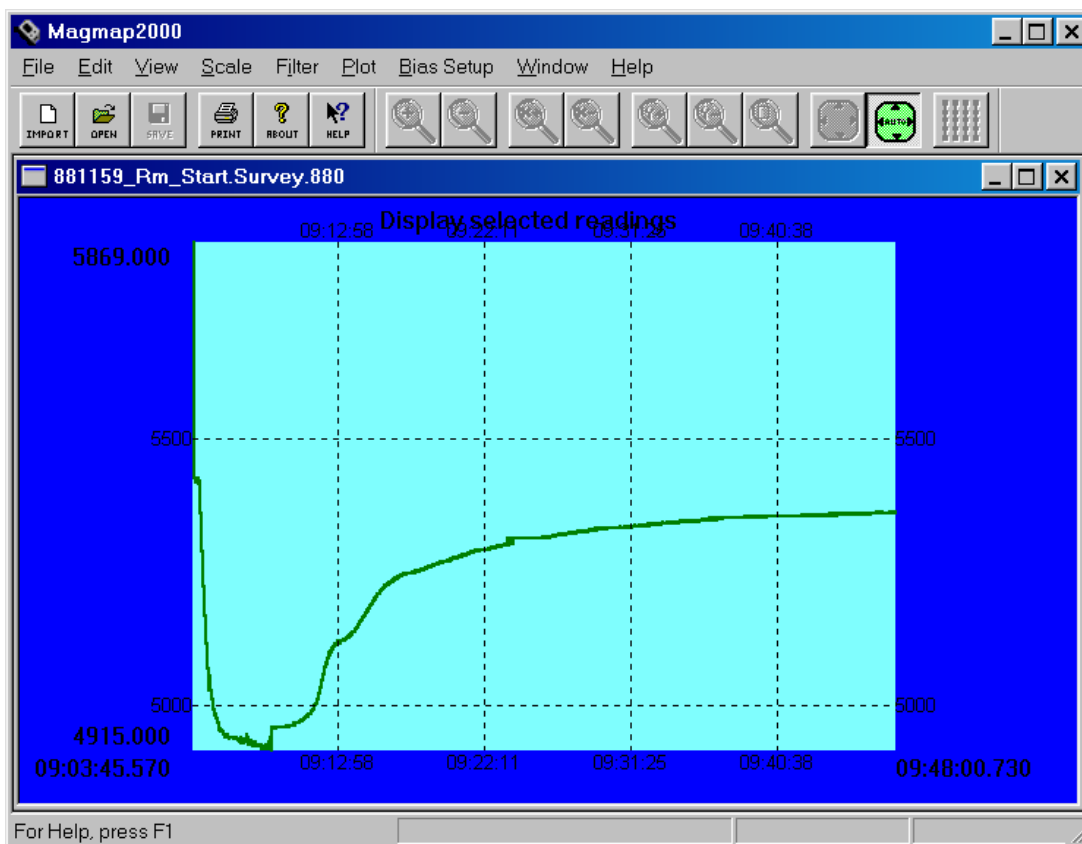

Figure 69  
Select the magnetometer data from the various windows displayed in MagMap after opening a Survey File. Then right-click the center of the display area and choose the appropriate trace from the Plot Sensors Dialog

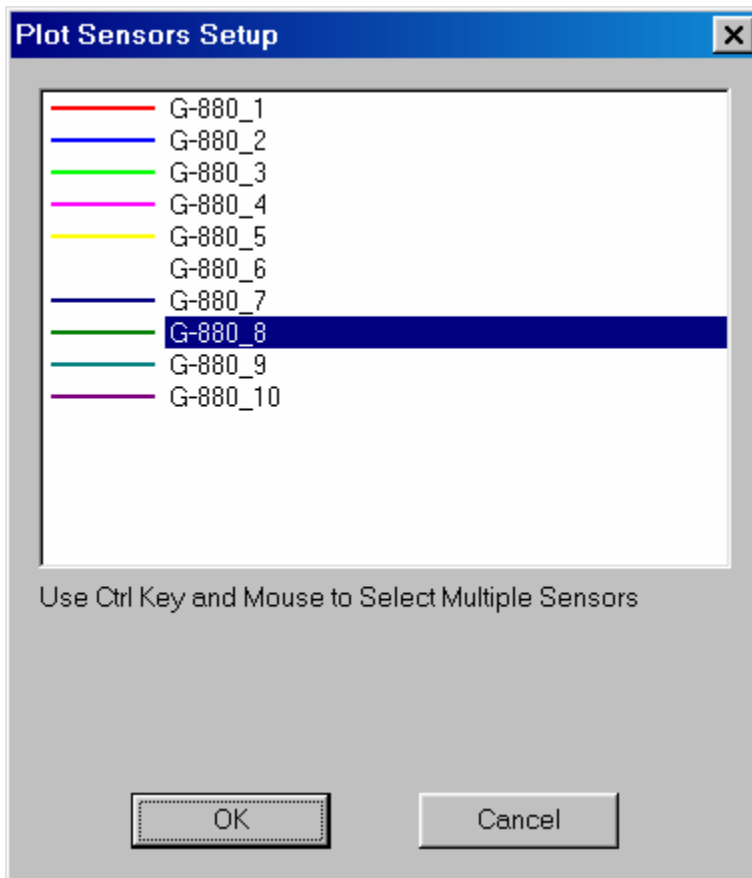

Figure 70

Here is an example of a trace chosen from the Plot Sensors Setup dialog.

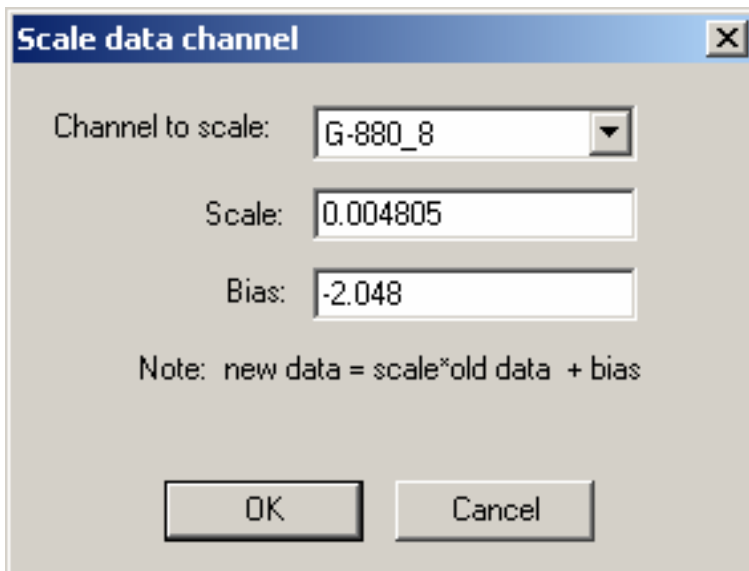

Figure 71

Next click on the Bias Setup menu item and choose the Scale data... item. You can enter Scale and Bias for the selected channel and click OK to apply the calibration.

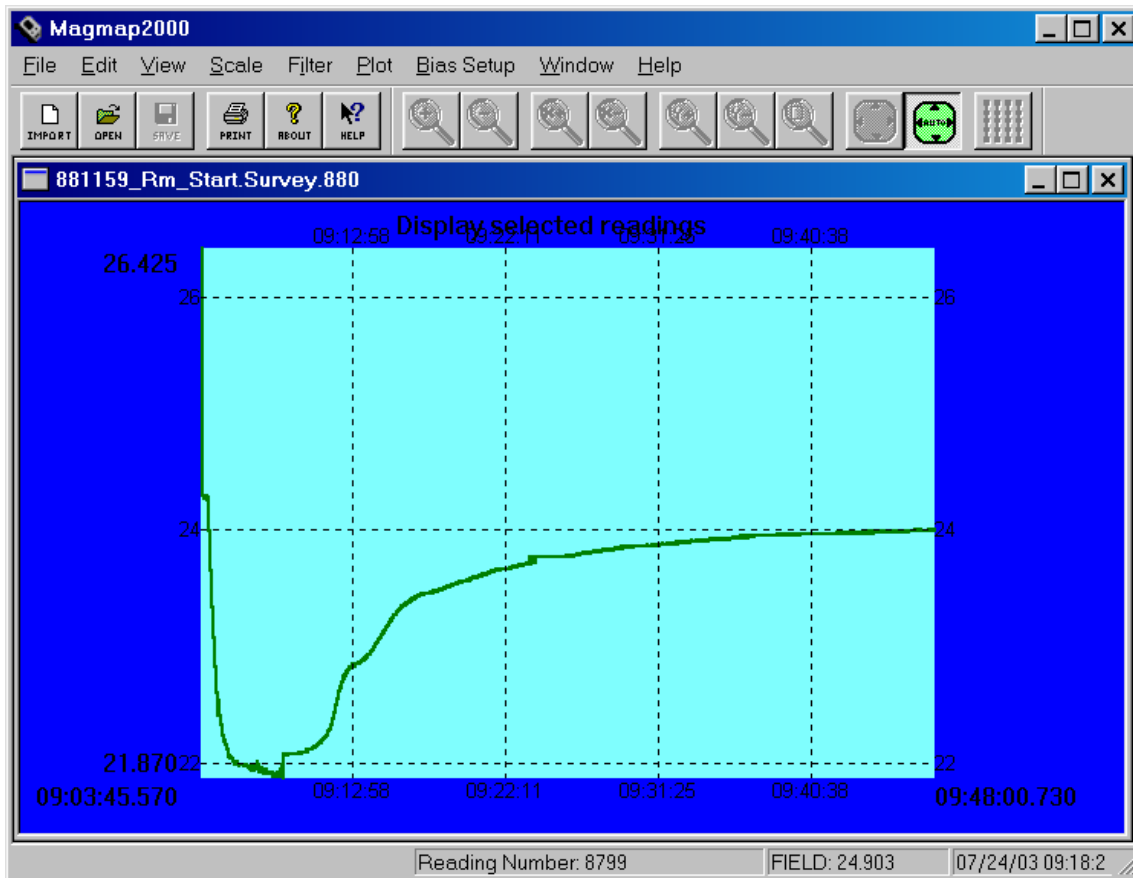

Figure 72  
The data is now scaled in Volts DC.

## NOTES



## Appendix A – Optically Pumped Magnetometer Theory

*Note: The following section is provided for information purposes only. Understanding this theoretical discussion is not required for proper operation of the magnetometer.*

For purposes of this discussion, the ambient magnetic field or earth's magnetic field is called  $H_0$ . A separate magnetic field generated by an AC signal applied to a coil inside the sensor is called  $H_1$ . Refer to the drawing on the next page for the following discussion.

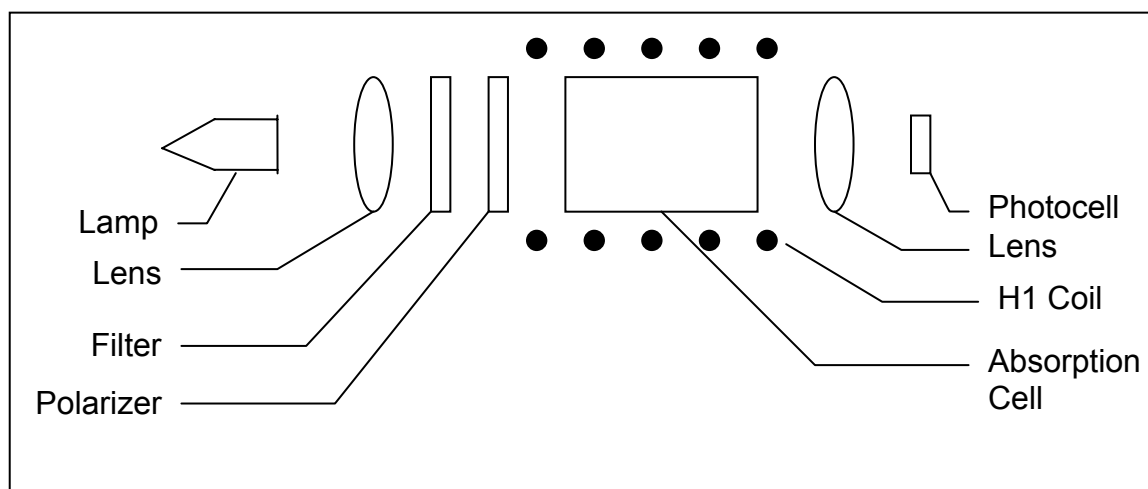

G-882 CESIUM SENSOR

To initiate operation of the sensor, the lamp oscillator's RF power increases until the lamp strikes (plasma ignites and fluoresces). The lamp oscillator then reduces its power to produce the regulated amount of light. The heater warms the absorption cell until a Cesium vapor is formed. A lens bends the light from the lamp to parallel rays. The lamp produces many spectral lines but only one line in the infrared region is employed. All of the other light is blocked by a high grade optical filter.

The infrared line of interest is then passed through a split-circular polarizer. On one side of the polarizer the transmitted light has an electrostatic vector that advances with a right-handed rotation. For conceptual purposes, it can be said that all of the photons in this light have the same right-hand spin direction. The light transmitted through the other side of the split-circular polarizer produces light in which the vector advances with a left-handed rotation, therefore having the opposite spin. Both circular polarized light beams pass through the absorption cell. Because there is a buffer gas in the cell, the single cell can be considered as two separate cells, each having the opposite sense polarized light passed through

it. Both light beams exit the cell and pass to a second lens. This lens focuses the light onto an infrared photo-detector.

Because Cesium is an alkali metal, the outer most electron shell (orbit) has only one electron. It is the presence of this single electron that makes the Cesium atom well-suited for optical pumping and therefore magnetometry.

The Cesium atom has a **net magnetic dipole moment**. This net dipole moment, termed **F**, is the sum of the **nuclear dipole moment**, called **I**, and the **electron's angular momentum**, called **J**. In a Cesium atom:

$$\mathbf{I} = 7/2$$

$$\mathbf{J} = 1/2$$

and thus **F** can have two values depending on whether the electron's angular momentum adds to or subtracts from the nuclear dipole moment. Therefore, **F** can have the value of **3** or **4**. These values are called the hyperfine energy levels of the ground state of Cesium.

Normally the net dipole moments are randomly distributed about the direction (vector sum of the 3 axial components) of the ambient magnetic field ( $H_0$ ). Any **misalignment** between the net atomic dipole moment and the ambient field vector causes the Cesium atom be at a higher energy level than if the vectors were aligned. These small differences are called **Zeeman splitting** of the base energy level.

The laws of quantum electrodynamics limit the inhabitable atomic magnetic dipole orientations and therefore the atomic excitation energy to several discreet levels: 9 levels for the **F=4** state and 7 levels for the **F=3** state. *It is this variation in electron energy level state that is measured to compute the ambient magnetic field strength.*

When a photon of the infrared light strikes a Cesium atom in the absorption cell, it may be captured and drive the atom from its present energy level to a higher energy level. To be absorbed the photon must not only have the exact energy of the Cesium band gap (therefore the narrow IR line) but must also have the correct spin orientation for that atom.

There is a high probability that the atom will immediately decay back to the initial energy level but its original orientation to the ambient field is lost and it assumes a random orientation. An atom that returns to the base level aligned such that it can absorb another photon, will be driven back to the higher state. Alternately, if the atom returns to the base level with an orientation that does not allow it to absorb an incoming photon, then it will remain at that level and in that orientation. Atoms will be repeatedly driven to the higher state until they happen to fall into the orientation that cannot absorb a photon. Consequently, the circularly polarized light will depopulate either the aligned or inverse aligned energy states depending

on the orientation (spin) of light polarization. Remember that one side of the cell is right-hand polarized and the other left-hand polarized to minimize sensor rotational light shifts and subsequent heading errors.

Once most of the Cesium atoms have absorbed photons and are in a state that does not allow them to absorb another photon, the light absorption of the cell is greatly reduced, i.e., more light hits the photo-detector. If an oscillating electromagnetic field of the correct radio frequency is introduced into the cell, the atoms will be driven back (depopulating the energy level) into an orientation that will allow them to absorb photons again. This frequency is called the Larmor frequency and is exactly proportional to the energy difference caused by the Zeeman splitting mentioned previously. This energy splitting is in turn directly proportional to the ambient magnetic field strength. The relationship between frequency and energy is given by:

$$E = f\hbar$$

Where:

- E is the Zeeman energy difference
- f is the frequency of the Larmor
- $\hbar$  is Planck's constant

In Cesium this Larmor frequency is exactly 3.498572 times the ambient field measured in nano-Teslas (gammas). In the G-882 this radio frequency field is generated by a coil, called the H1 coil, wound around the tube holding the optical components. When the RF field is present the total light passing through the cell is reduced because atoms are in an energy state in which they can again absorb the infrared light.

There is a small variation in the atomic light absorption at the frequency of the applied H1 depopulation signal. This variation in light intensity appears on the photo-detector as a small AC signal (microvolts). If this AC signal is amplified and shifted to the correct phase, it can be fed back to the H1 coil to produce a self sustaining oscillation. In practice simply connecting the 90° phase shifted and amplified signal to the H1 coil will cause the oscillation to spontaneously start. Reversing the direction of the earth field vector ( $H_0$ ) through the sensor requires the drive to the H1 coil to be inverted to obtain oscillation. (See Automatic Hemisphere Switching, section 2.4.3).

## Appendix B – System Connection Wiring Diagrams

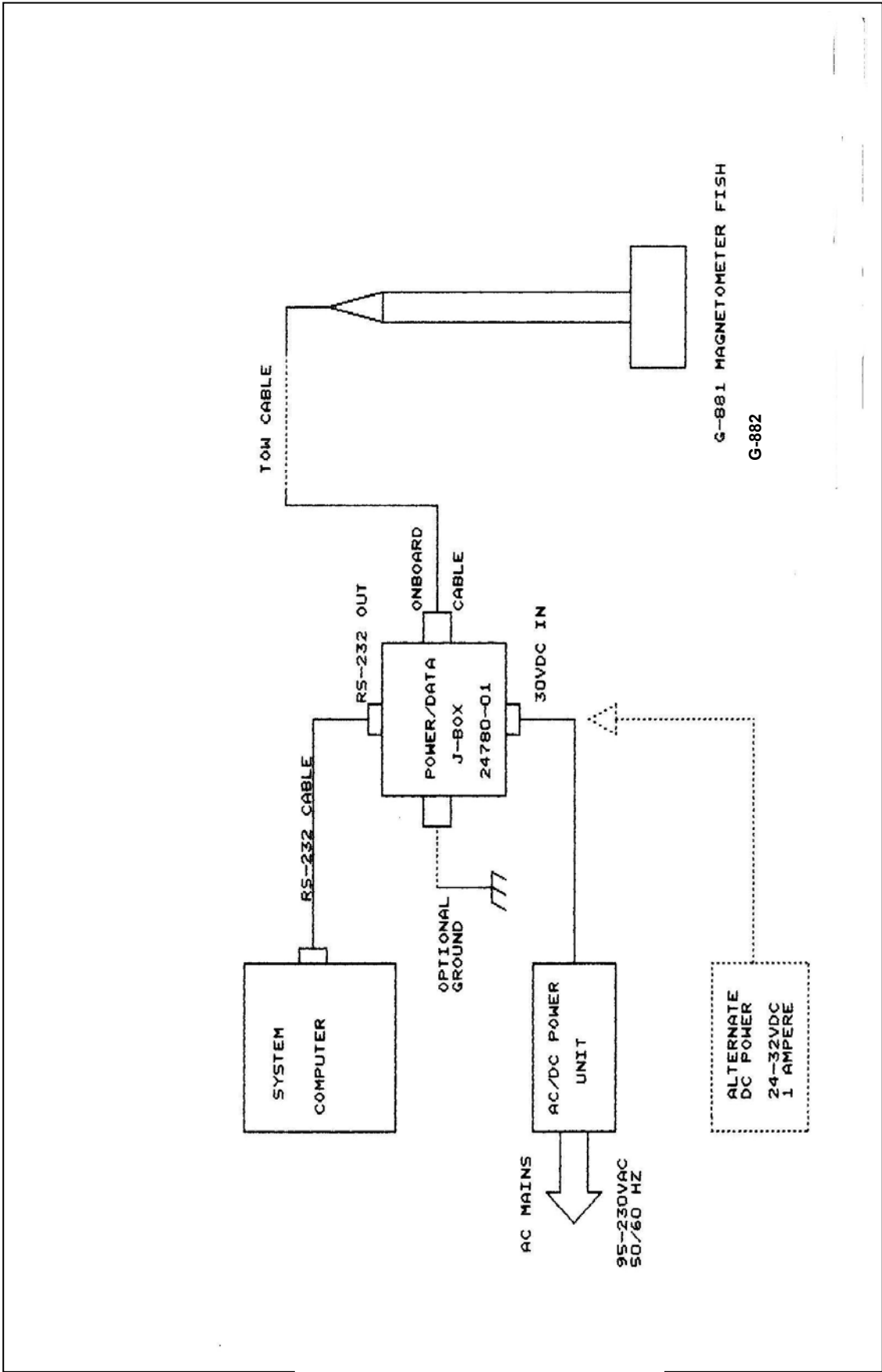

System Connection Diagram

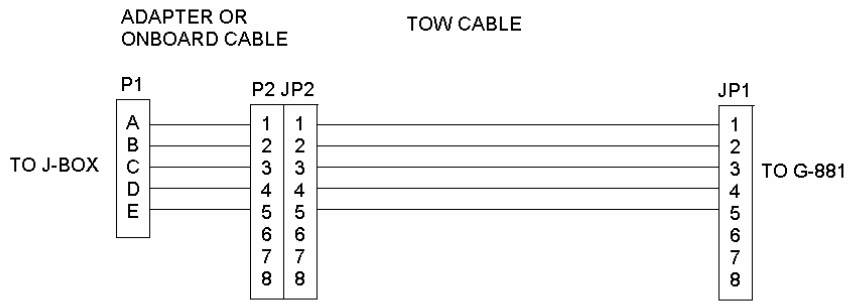

**WIRE TABLE**

| P1 | P2,JP2,JP1 | WIRE COLOR   | FUNCTION |
|----|------------|--------------|----------|
| A  | 1          | WHT 14GA     | +30VDC   |
| B  | 2          | WHT/BLK 14GA | 30 VRET  |
| C  | 3          | WHT          | RX DATA  |
| D  | 4          | WHT/BRN      | TX DATA  |
| E  | 5          | WHT/BLK      | GND      |

PINS 6,7,8  
NOT USED

**NOTE:**  
If you have a tow cable purchased before March 2001, you may not have an adapter cable. The pin out for your tow cable would be the same as the Adapter Cable.

**TOW CABLE WIRING DIAGRAM**

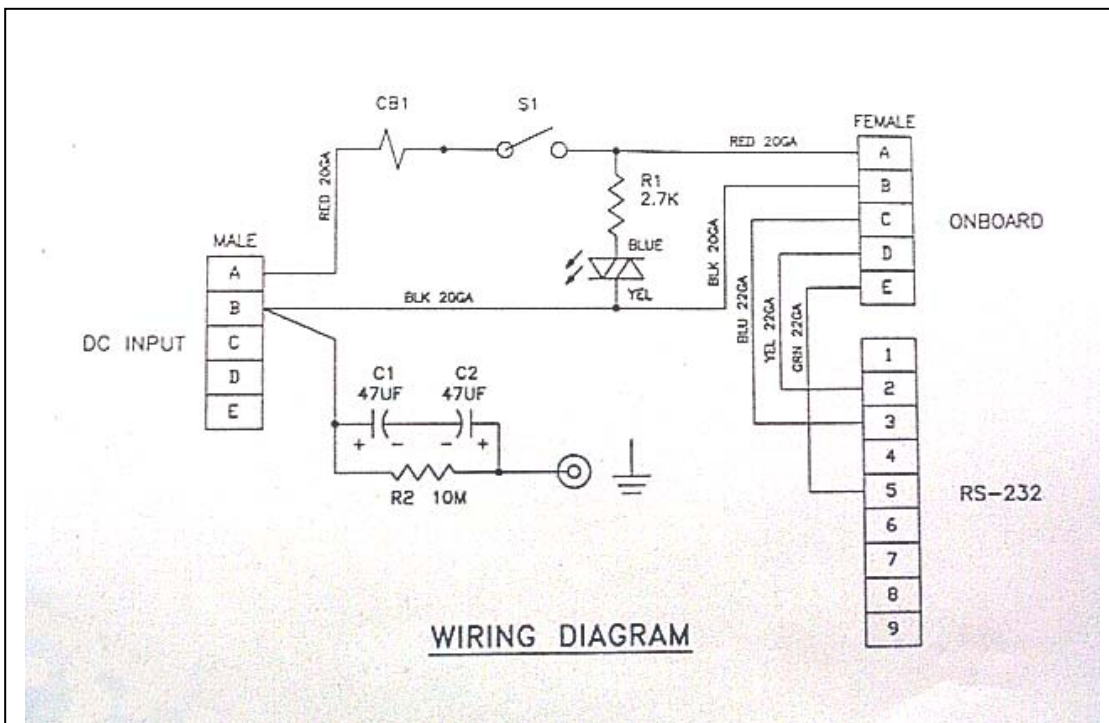

**WIRING DIAGRAM**

**24870-01 DC/DATA JUNCTION BOX**

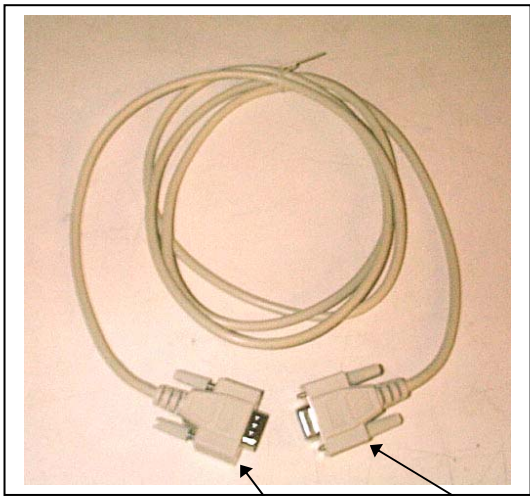
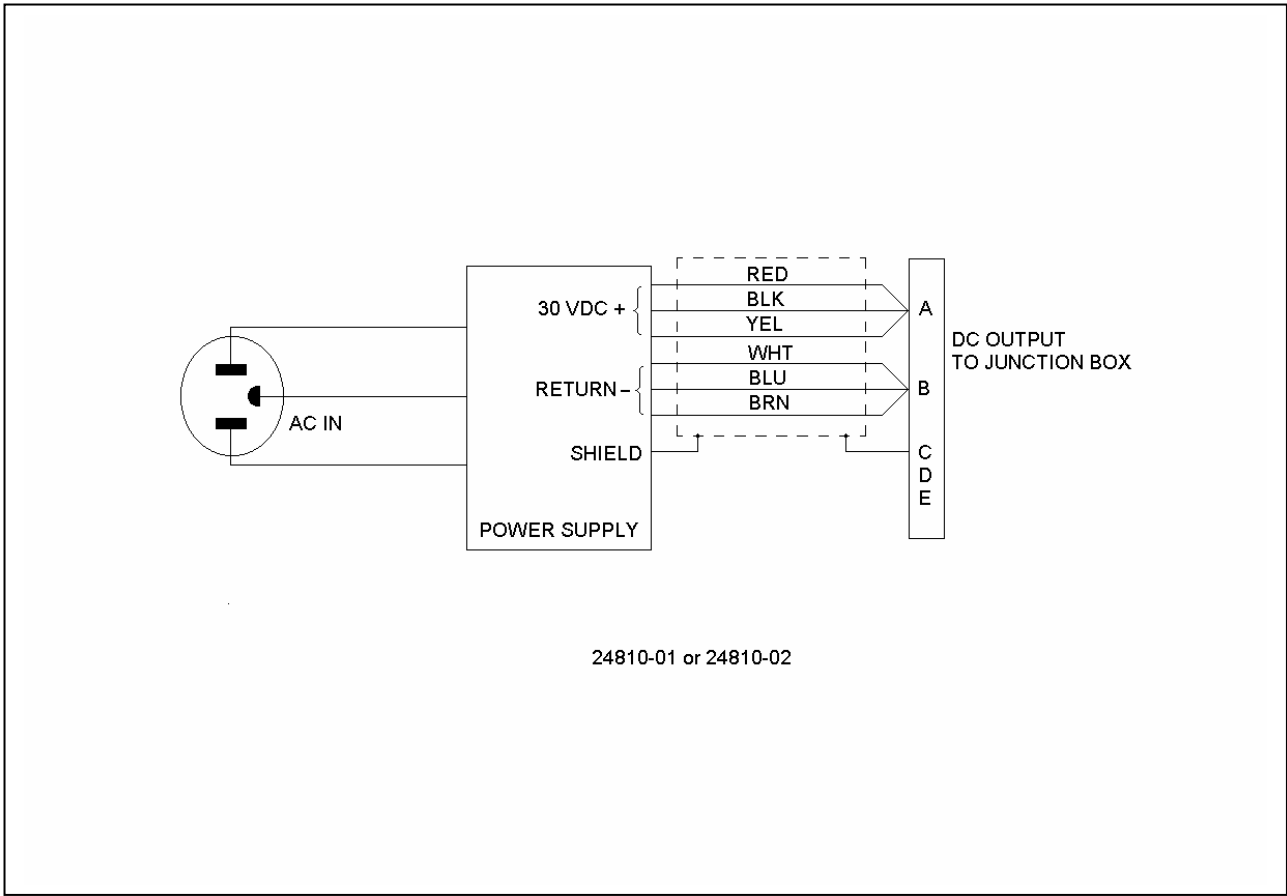

**SERIAL CABLE**  
Wired pin to pin, 1 to 1, 2 to 2, .....

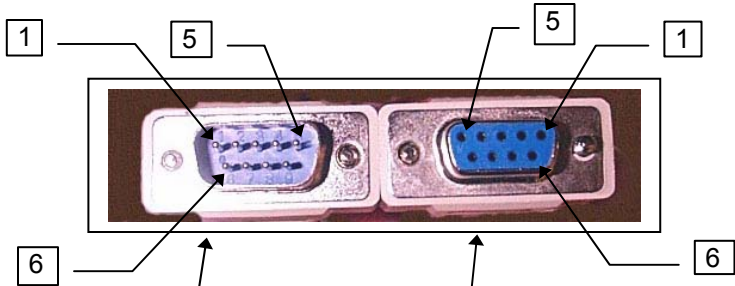

- Logging Computer  
Serial Connector  
Pin Out
- 1 DCD
  - 2 RX
  - 3 TX
  - 4 DTR
  - 5 Sig Gnd
  - 6 DSR
  - 7 RTS
  - 8 CTS
  - 9 RI

Connect to the J-Box

Connect to the logging computer

## Appendix C: G-882 With Larmor Output

If you did not purchase this special version of the G-882 magnetometer then the following does not apply.

This version of the G-882 Magnetometer is modified to provide the analog Larmor signal out a coaxial TNC connector at the white junction box so that it can be counted externally, as well as being internally counted and output via the serial port.

To get the analog Larmor signal from the magnetometer electronics to the outside world, a special tow cable is used to bring the Larmor signal to the white junction box through a coax cable inside the tow cable. In addition there is extra wiring added inside the G-882 fish and in the white junction box to pass the Larmor signal.

The G-882 is powered normally using a 28-volt supply through the white junction box. The serial magnetometer data (internally counted) is sent to the 9-pin connector on the white junction box as with a standard G-882. The only external differences on the system are the addition of the TNC analog Larmor output connector, a bigger connector (more pins) to interface the white box to the tow cable, and the special tow cable itself.

The analog Larmor signal is a sine wave whose frequency is proportional to the earth's magnetic field, and whose amplitude is related to the angle of the sensor axis to the earth's vector. The Larmor frequency is 3.498275 times the total field value. Thus for a 50,000 nT field the Larmor output frequency would be approximately 175 KHz. The amplitude of the Larmor signal is approximately 2 volts peak to peak at optimum orientation (sensor axis at 45 degrees to the earth's vector) and diminishing from there as the sensor is rotated toward either the polar or equatorial dead zones.

Unlike many magnetometer installations, the output Larmor signal is not superimposed on the DC power, nor can the magnetometer be powered through the TNC connector. The power to the magnetometer must be supplied through the power connector on the white junction box. The Larmor output is AC coupled through a 0.1uF capacitor inside the G-882.

At power up it is possible that a 28-volt positive transition may couple through to the TNC Larmor output connector. The input to the external counter should be protected against this transition (see the attached power/Larmor wiring diagram TD99873 for a system level look at how the Larmor signal is routed).



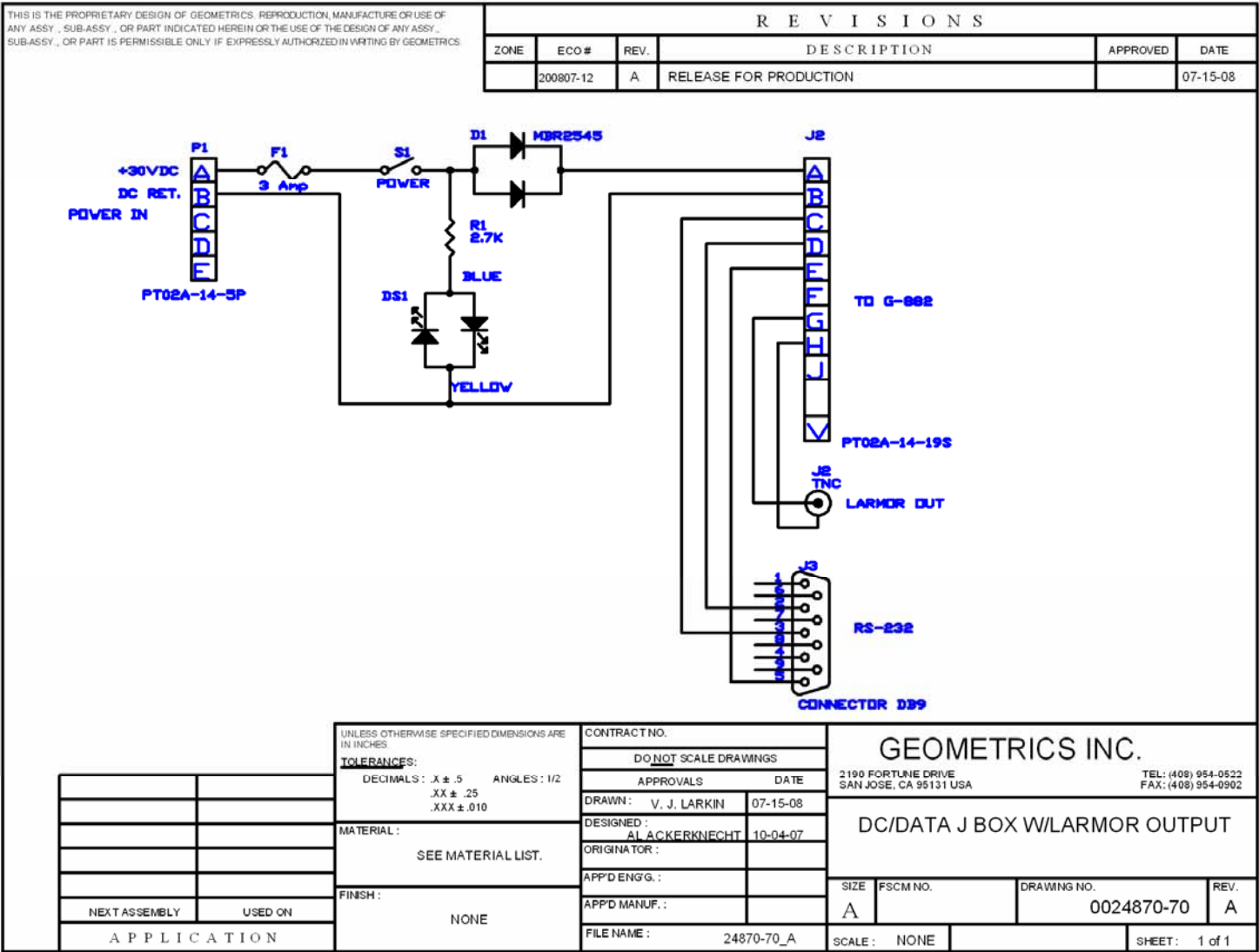

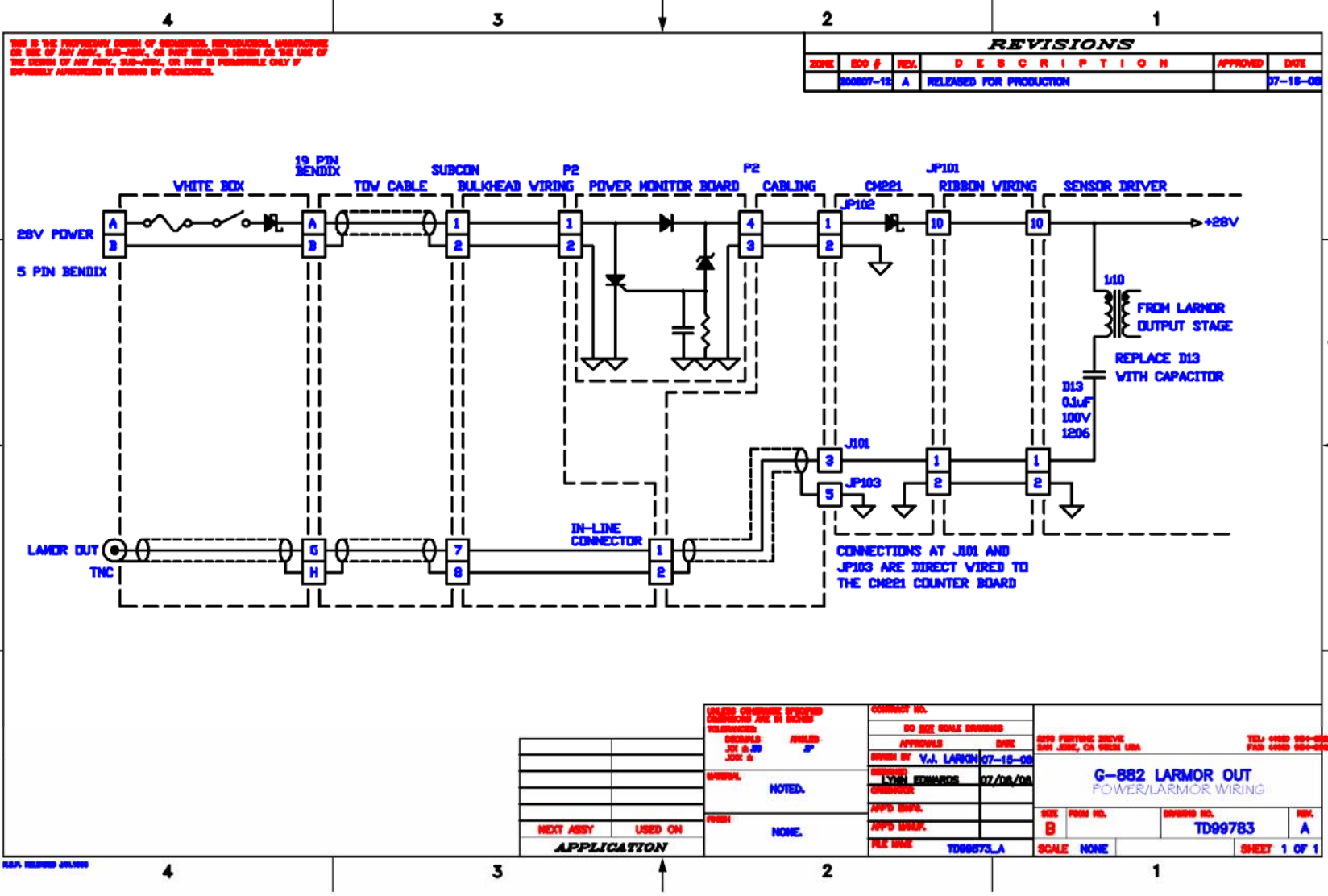



## Computer Installation Service Bulletin

### Fix for SocketIO cards in Windows 9X Computers

January 15, 2000

Sometimes a Windows 95 or Windows 98 computer with a SocketIO card will not recognize the card's serial port from a command prompt. Symptoms are that Hyperterminal and other Windows applications are able to use the SocketIO serial port, but DOS programs like View201 do not recognize the port or are unable to use it. The following procedure "tricks" the computer into thinking that the serial port is indeed installed.

- 1) Make sure the SocketIO serial port works from Windows. You can easily verify by using Hyperterminal.
- 2) Open the Control Panel and double click on System. Click the Device Manager tab of the System Properties window, then click the plus in the box to the left of the Ports(COM & LPT) item.
- 3) Click once on the Socket PCMCIA Serial Adapter, then click the Properties button near the bottom of the System Properties window.
- 4) Click the Resources tab of the resultant Properties window and write down the Setting for Input/Output Range.
- 5) Create a text file named, "fixcom.bat", in the C:\Bat directory. Make a new folder if necessary. Fixcom.bat should contain one line:  
C:\windows\command\debug < C:\bat\fixcom.txt
- 6) Create a text file named, "fixcom.txt", in the C:\bat directory. Fixcom.txt should contain four (4) lines:  
d 40:0  
e 40:02 f8 02     *(The last two entries are the first address from Port Settings)*  
d 40:0  
q
- 7) Edit C:\Autoexec.bat to add the following line:  
call c:\bat\fixcom.bat